

VEGAS 19

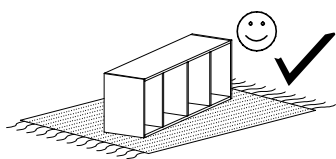

Narzędzia potrzebne do montażu



UWAGA !!!

MONTOWANIE USZKODZONYCH
ELEMENTÓW POWODUJE UTRATĘ
GWARANCJI

Nr	D[mm]	S[mm]	G[mm]	Ilość
1	1500	700	48	1
2L	2000	200	48	1
2P	2000	200	48	1
3	1500	400	48	1
4	1985	200	48	1
5	295	190	48	2
6	140	70	48	4
7	1400	30	3	1

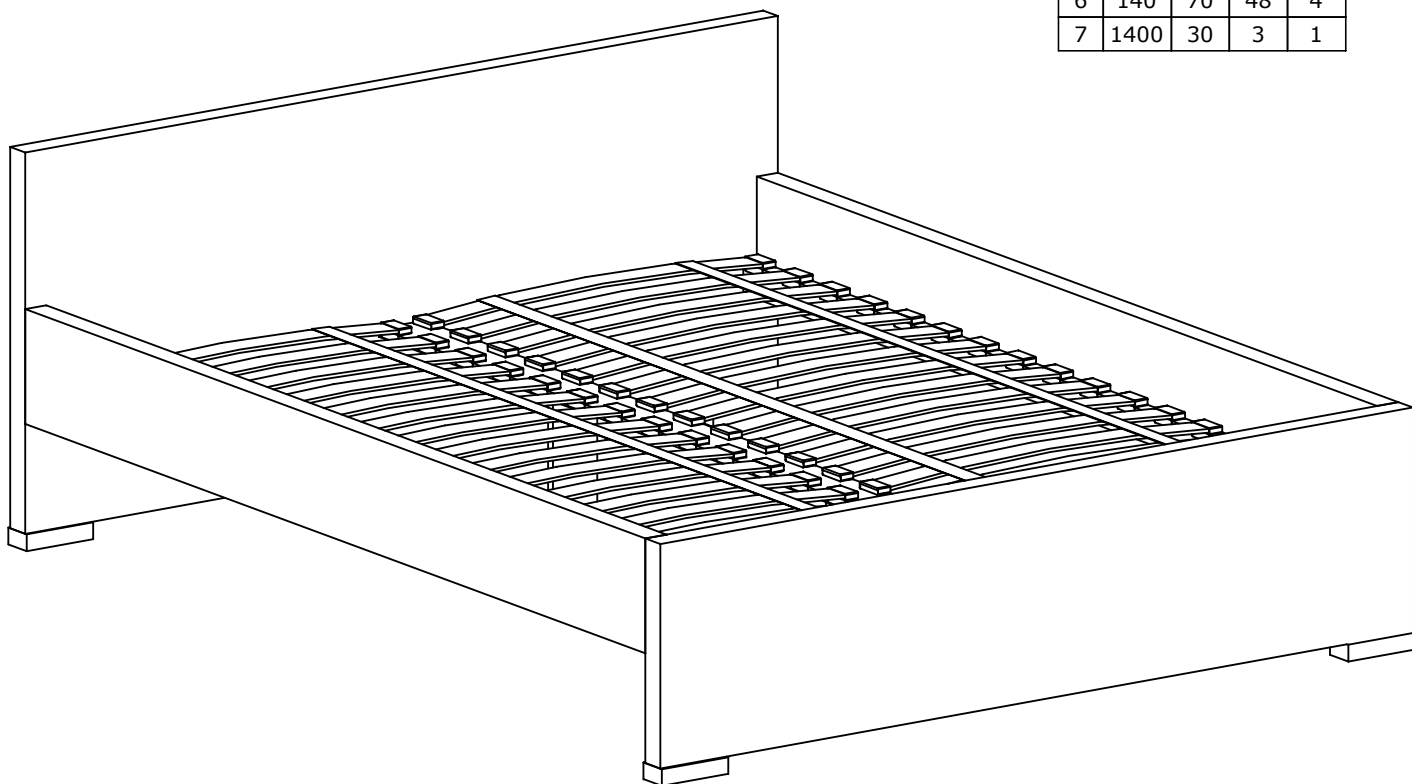

W przypadku reklamacji proszę podać numer pakowacza znajdujący się na kartonie.

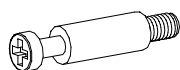

K - 4 St.



L - 4 St.

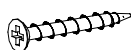

J - 4 St.
3,9x30 mm

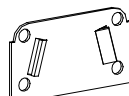

C - 2 St.

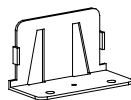

D - 2 St.



A - 4 St.
7x70 mm



E - 14 St.
4x25 mm

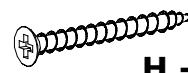

H - 8 St.
4x60 mm

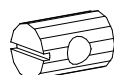

W - 4 St.



B - 8 St.



Z - 1 St.

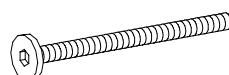

S - 4 St.



G - 12 St.
4x35 mm

I

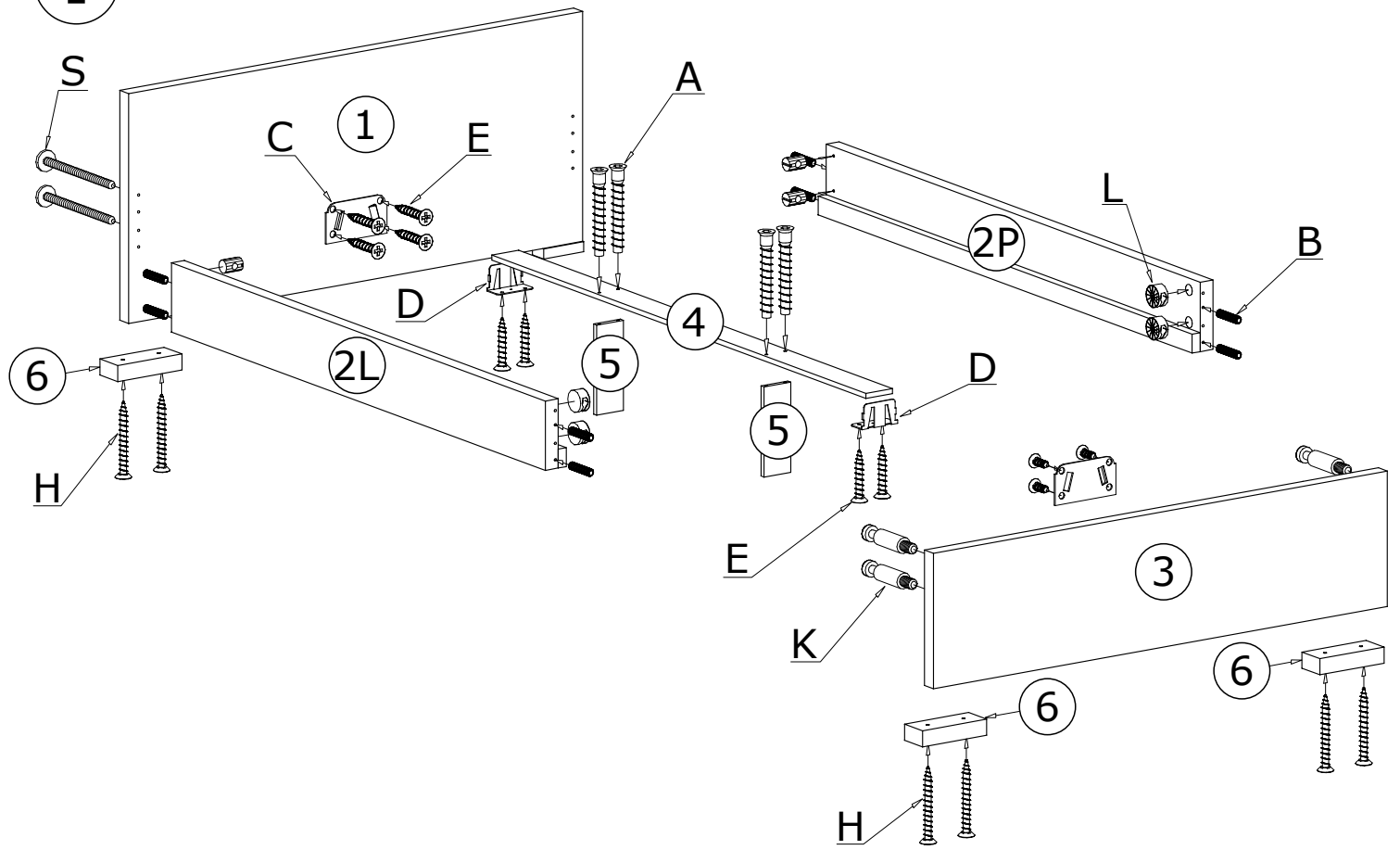

II

