

# VEGAS 38

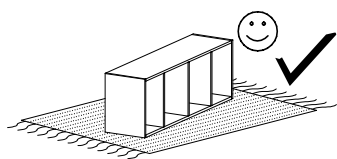

Narzędzia potrzebne do montażu

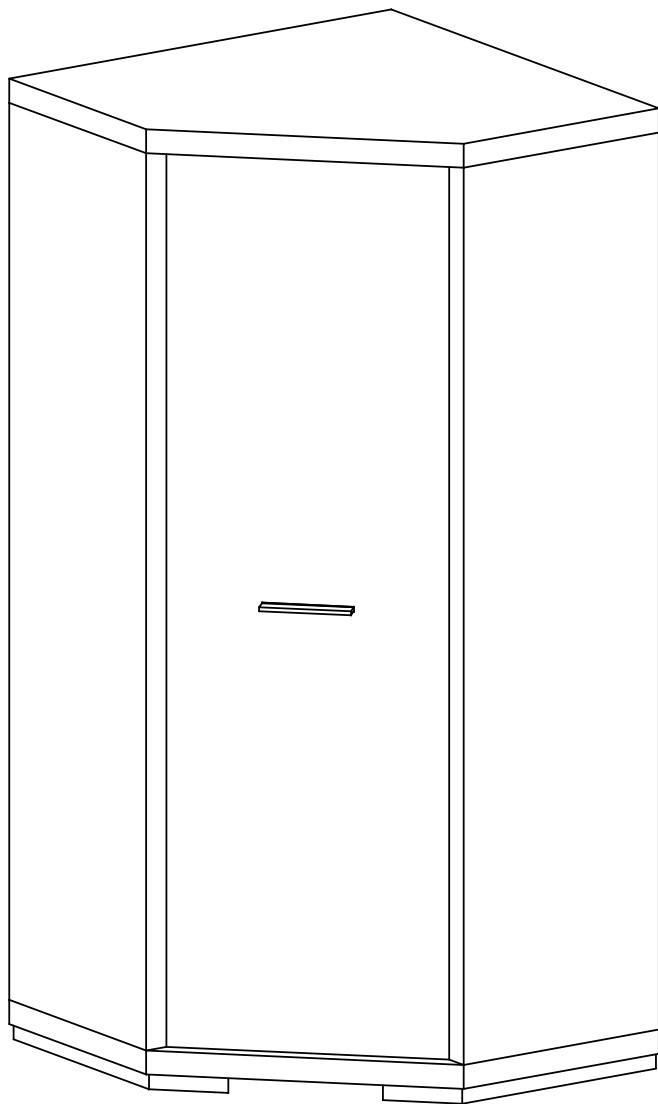

## UWAGA !!!

MONTOWANIE USZKODZONYCH  
ELEMENTÓW POWODUJE UTRATĘ  
GWARANCJI

Nr	D[mm]	S[mm]	G[mm]	Ilość
1	900	900	48	1
2	900	900	48	1
3	1793	460	48	1
4	1793	460	48	1
5	1790	350	16	1
6	1790	350	16	1
7	355	350	16	4
8	867	80	16	1
9	1780	557	16	1
10	1820	890	2,5	1
11	1820	564	2,5	1

W przypadku reklamacji proszę podać numer pakowacza znajdujący się na kartonie.

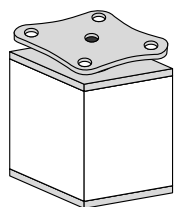

**A - 1 St.**

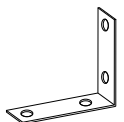

**Y - 2 St.**

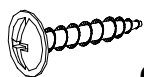

**Q - 4 St.**  
4x25 mm

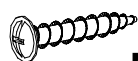

**N - 2 St.**  
4x30 mm



**U - 1 St.**

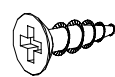

**G - 50 St.**  
3,5x16 mm

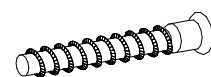

**W - 4 St.**

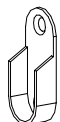

**T - 2 St.**



**E - 100 St.**

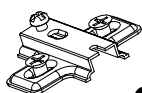

**C - 4 St.**

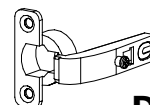

**D - 4 St.**



**M - 1 St.**

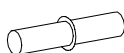

**P - 16 St.**



**B - 18 St.**

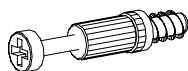

**K - 16 St.**

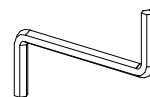

**Z - 1 St.**

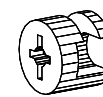

**L - 16 St.**

I

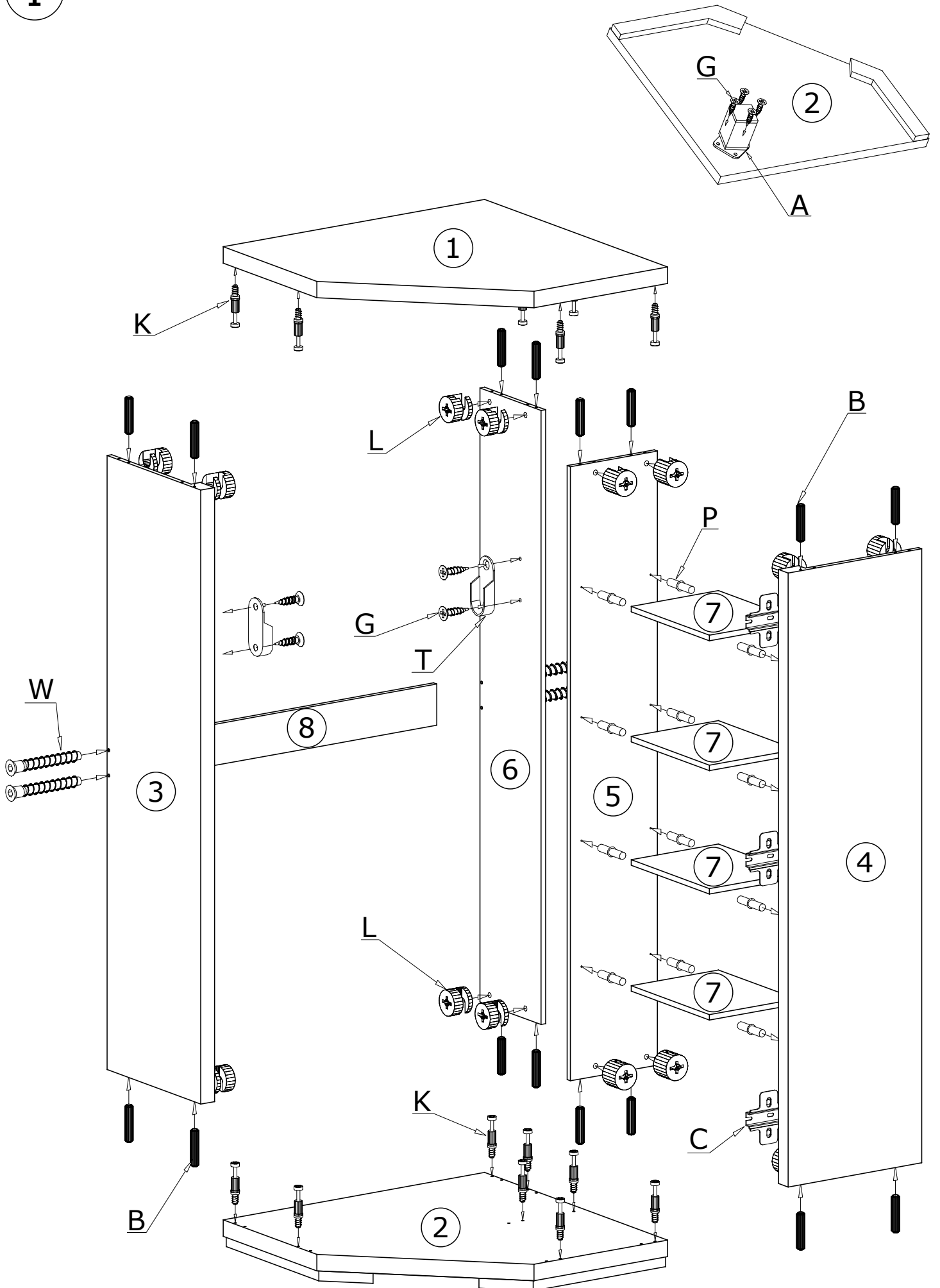

II

100X 

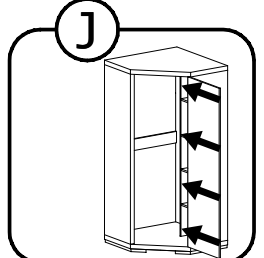
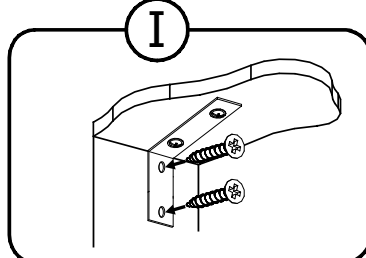
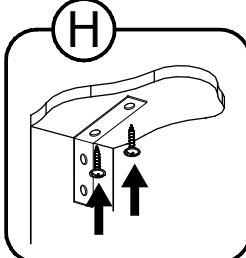
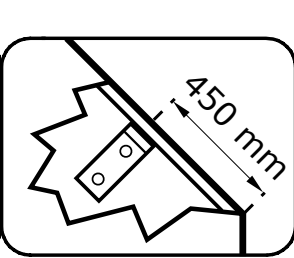
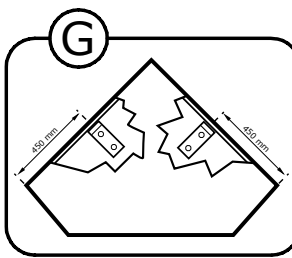
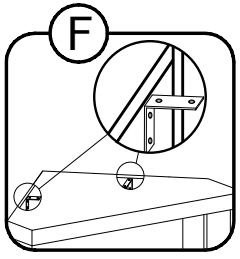
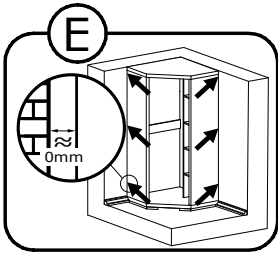
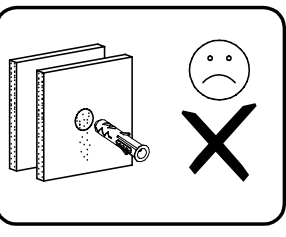
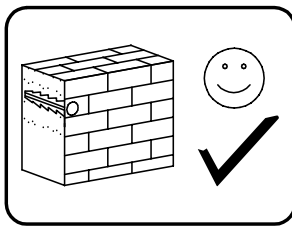
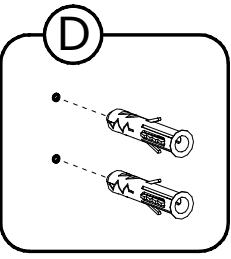
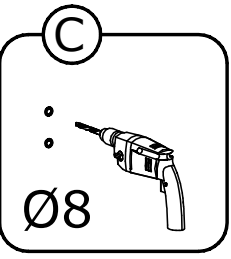
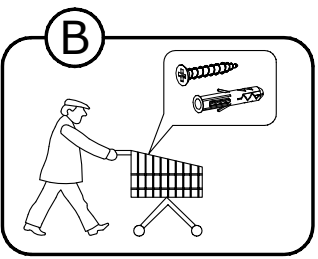
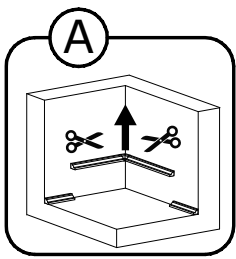
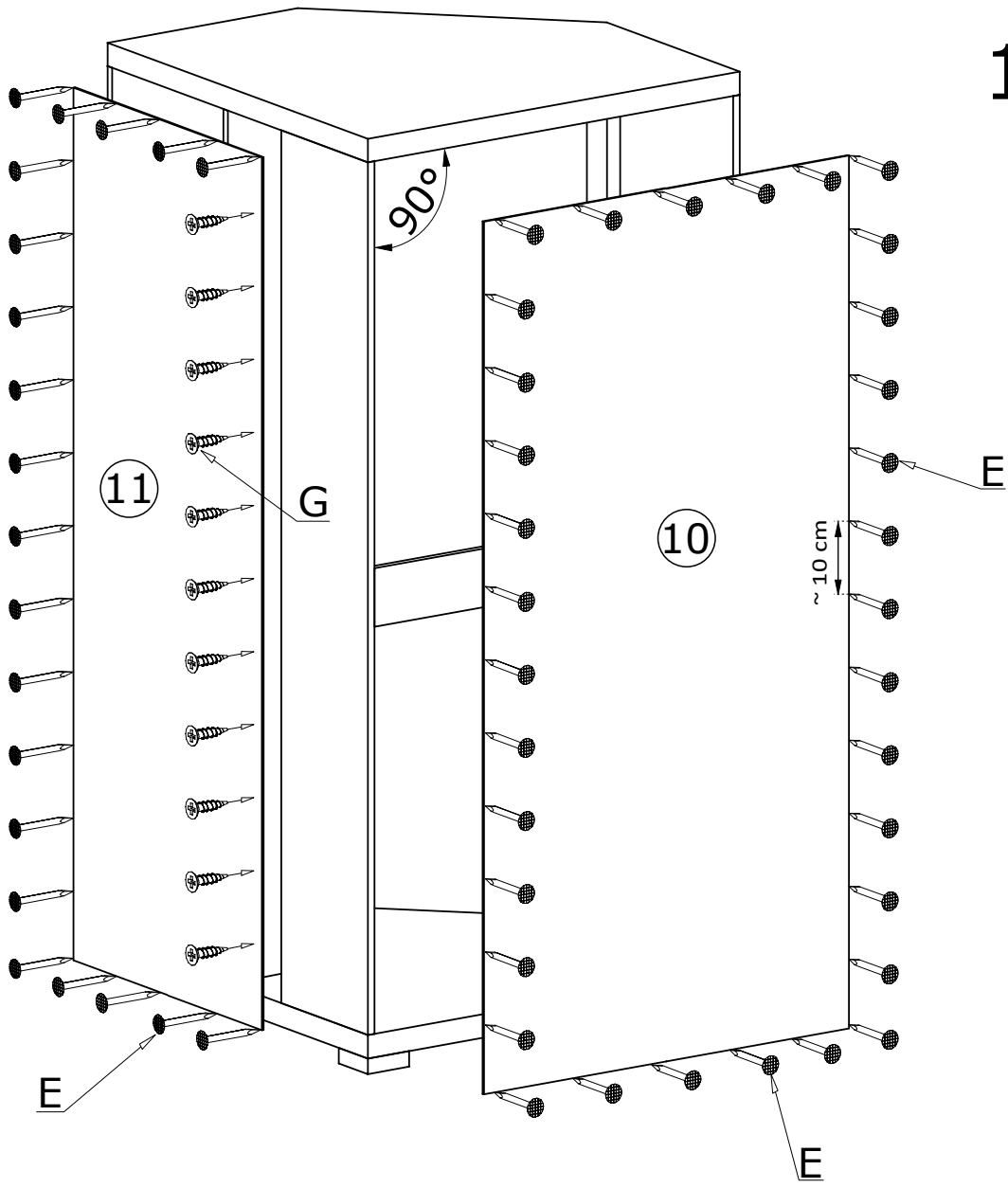

III

