

VEGAS 35



Narzędzia potrzebne do montażu



UWAGA !!!

MONTOWANIE USZKODZONYCH
ELEMENTÓW POWODUJE UTRATĘ
GWARANCJI

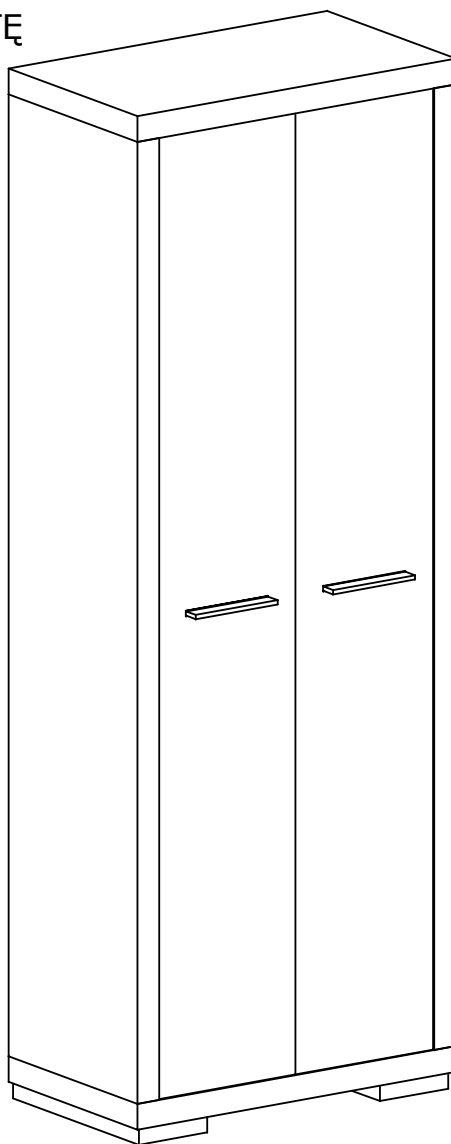

Nr	D[mm]	S[mm]	G[mm]	Ilość
1	703	407	48	1
2	703	407	48	1
3	1793	405	48	1
4	667	387	16	1
5	1793	405	48	1
6	667	320	16	3
7	1820	690	2,5	1
8	1783	297	16	1
9	1783	297	16	1

W przypadku reklamacji proszę podać numer pakowacza znajdujący się na kartonie.

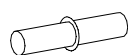

P - 12 St.

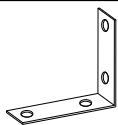

Y - 2 St.

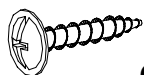

Q - 4 St.
3,5x16 mm

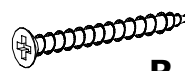

R - 6 St.
4x60 mm

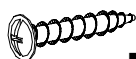

N - 4 St.
4x30 mm



U - 2 St.

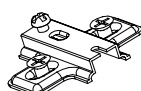

C - 6 St.

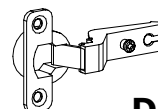

D - 6 St.



G - 12 St.
3,5x16 mm



E - 50 St.



B - 12 St.

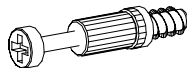

K - 12 St.



Z - 1 St.



L - 12 St.

I

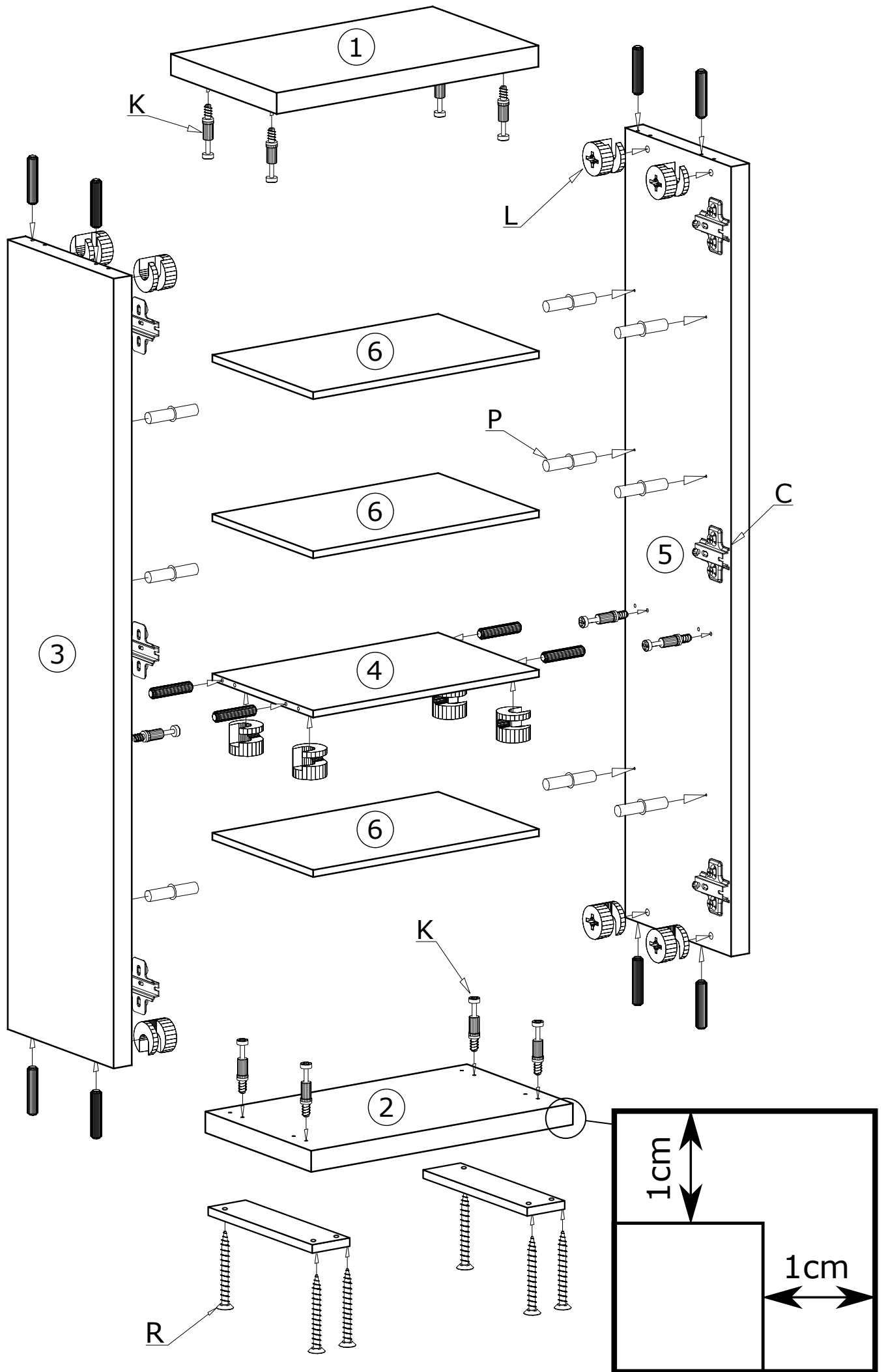

II

50X

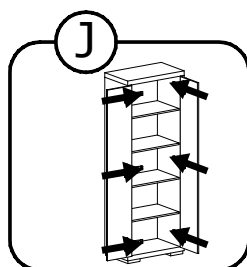
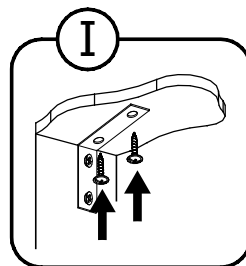
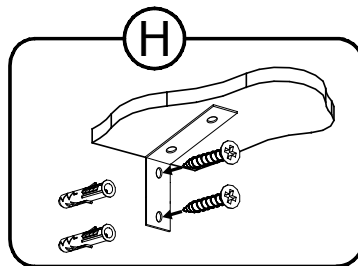
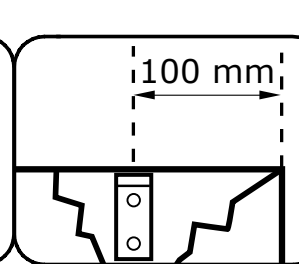
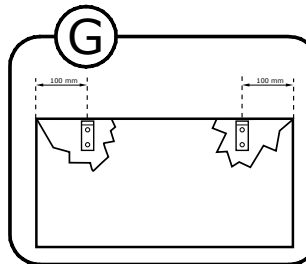
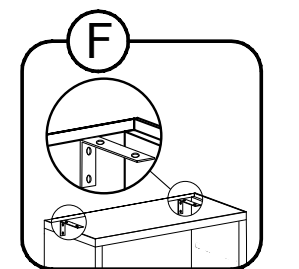
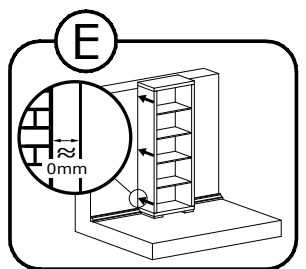
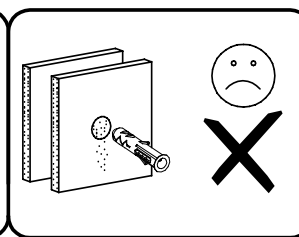
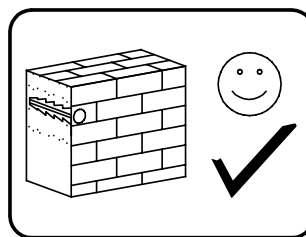
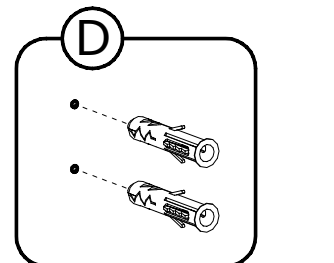
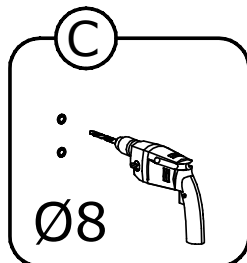
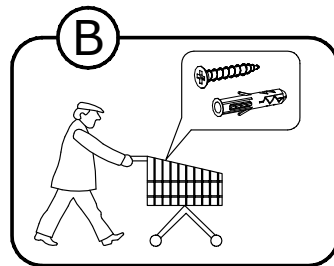
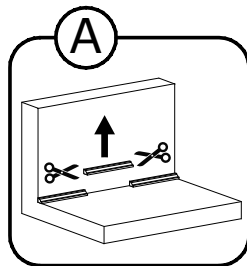
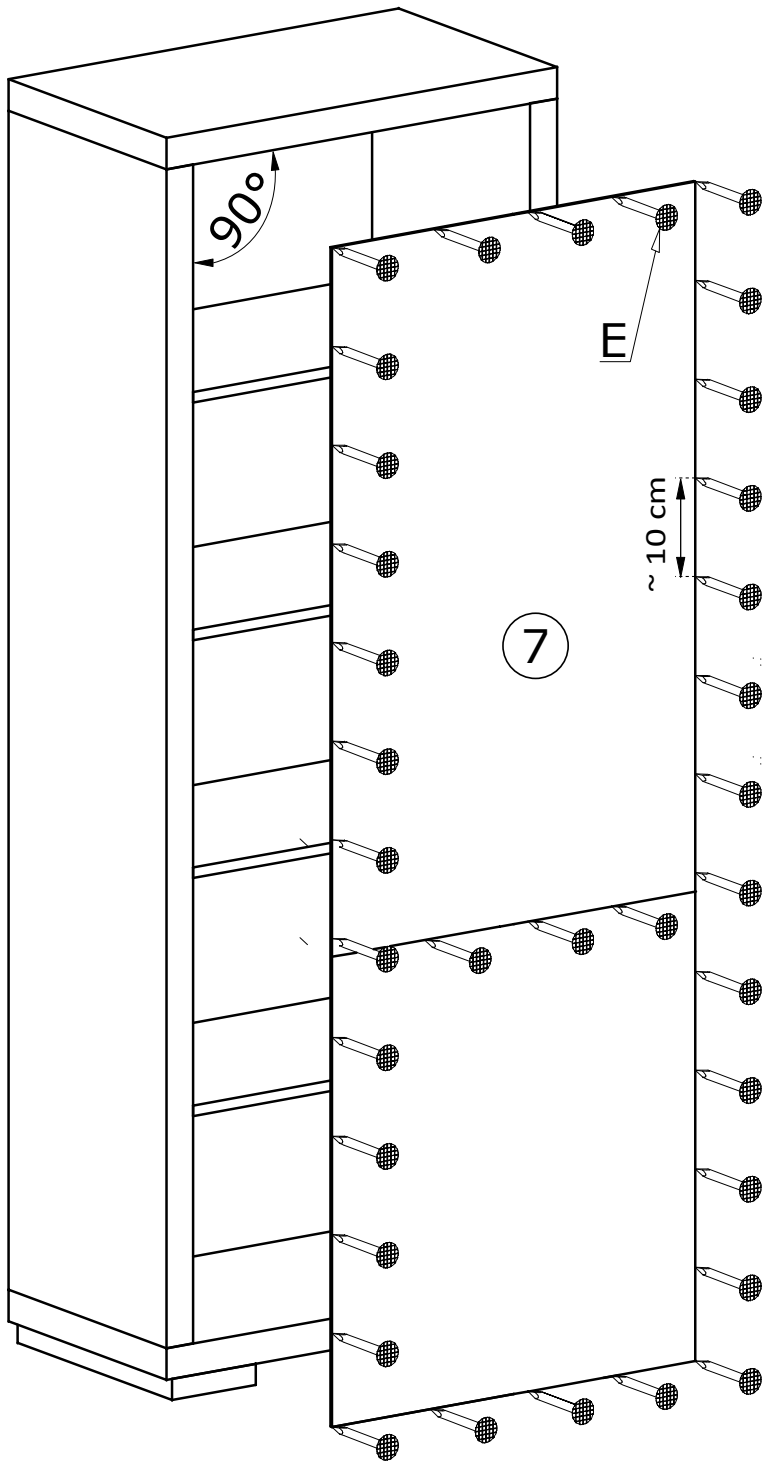

III

