

# VEGAS 27

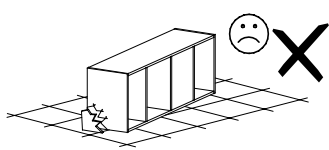

Narzędzia potrzebne do montażu

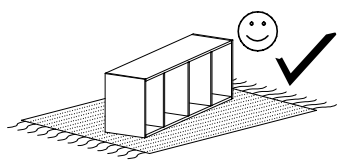
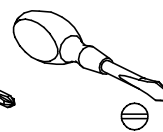
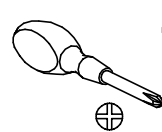
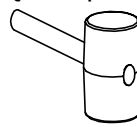
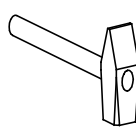

## **UWAGA !!!**

MONTOWANIE USZKODZONYCH  
ELEMENTÓW POWODUJE UTRATĘ  
GWARANCJI

Nr	D[mm]	S[mm]	G[mm]	Ilość
1	800	160	48	1
2	800	320	16	1

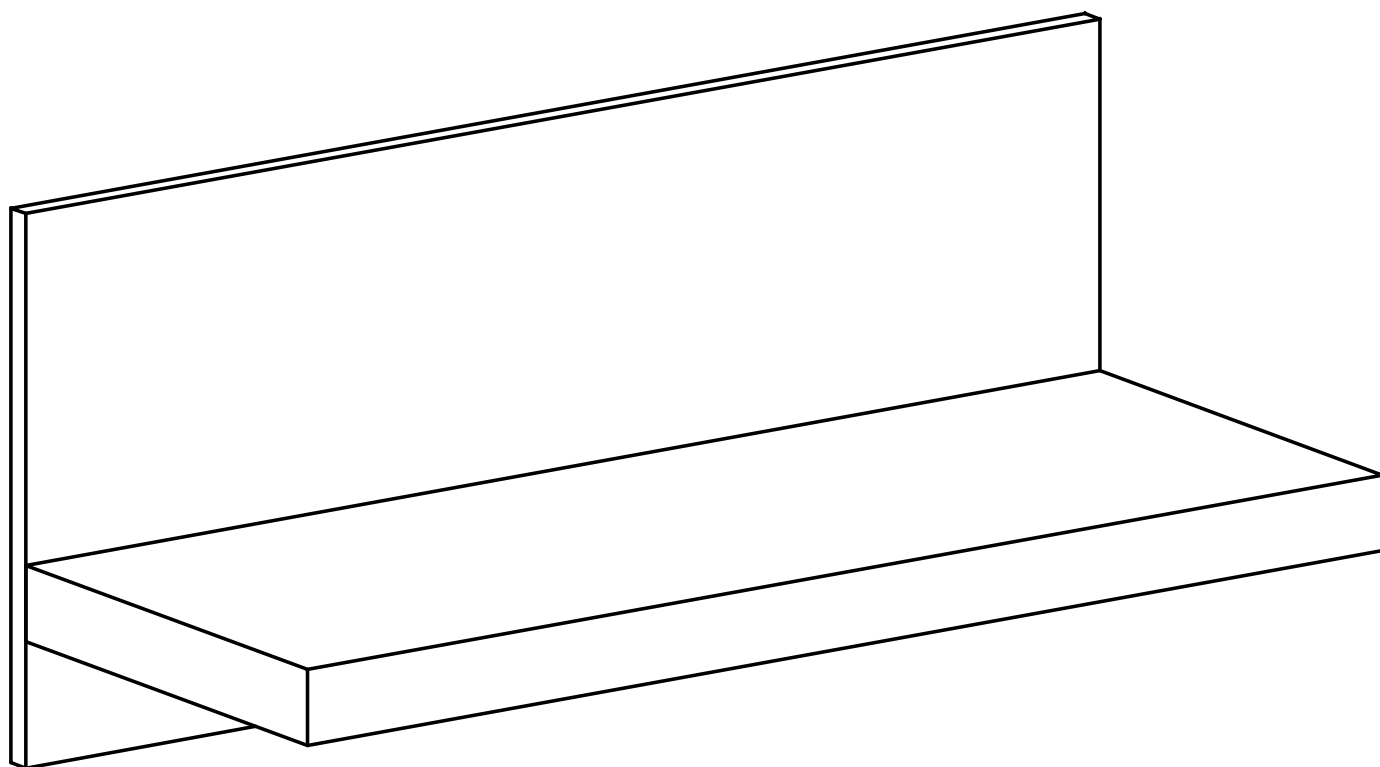

W przypadku reklamacji proszę podać numer pakowacza znajdujący się na kartonie.



**E - 2 St.**

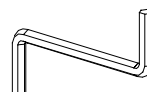

**Z - 1 St.**

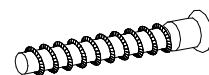

**W - 3 St.**

I

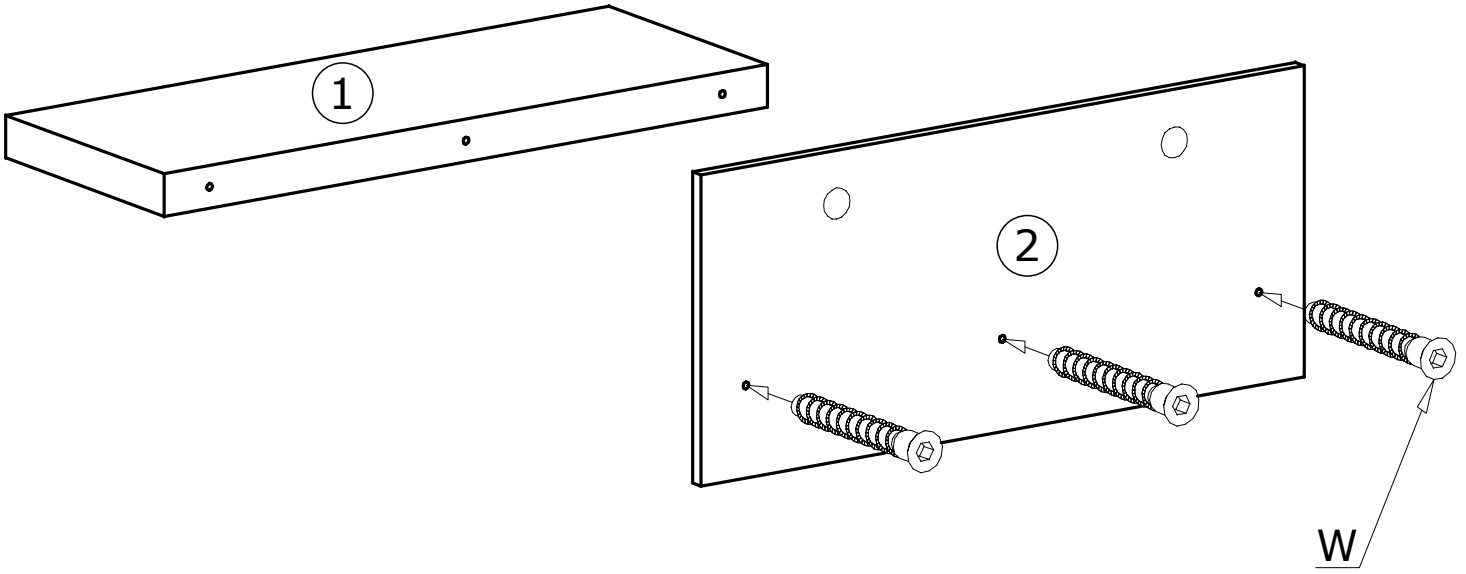

II

