

VEGAS 18

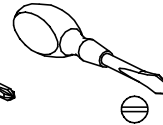

Narzędzia potrzebne do montażu

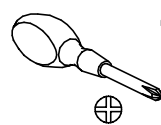
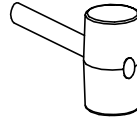
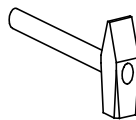

UWAGA !!!

MONTOWANIE USZKODZONYCH
ELEMENTÓW POWODUJE UTRATĘ
GWARANCJI

Nr	D[mm]	S[mm]	G[mm]	Ilość
1	802	500	16	1
2	802	120	16	1
3	903	602	48	1
4	560	600	48	1
5	560	600	48	1
6	802	120	16	1

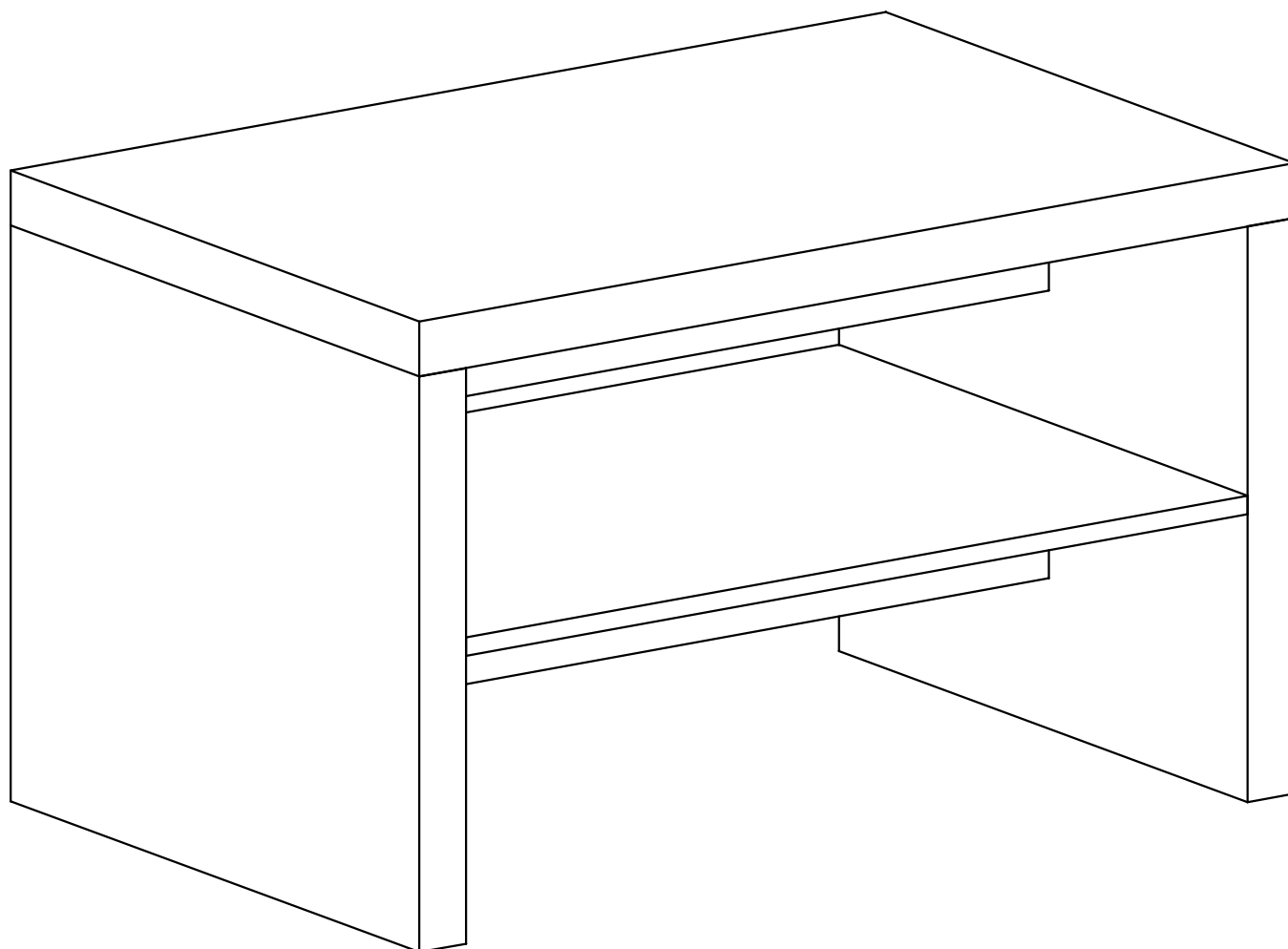

W przypadku reklamacji proszę podać numer pakowacza znajdujący się na kartonie.



Q - 4 St.



B - 10 St.

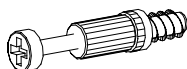

K - 18 St.

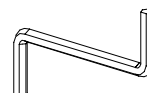

Z - 1 St.



L - 18 St.

I

