

VEGAS 12

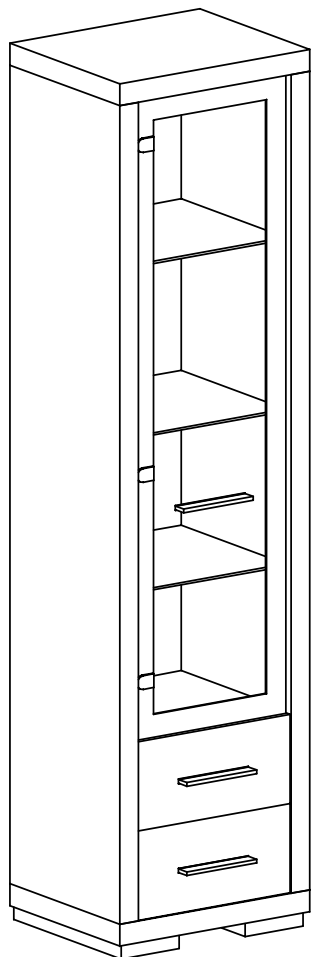

Narzędzia potrzebne do montażu



UWAGA !!!

MONTOWANIE USZKODZONYCH
ELEMENTÓW POWODUJE UTRATĘ
GWARANCJI

Nr	D[mm]	S[mm]	G[mm]	Ilość
1	493	407	48	1
2	493	407	48	1
3	1793	405	48	1
4	1793	405	48	1
5	458	398	16	1
6	457	320	4	1
7	350	165	16	2
8	336	165	16	2
9	350	165	16	2
10	362	355	2,5	2
11	388	190	16	2
12	1820	480	2,5	1
13	388	1394	4	1

W przypadku reklamacji proszę podać numer pakowacza znajdujący się na kartonie.

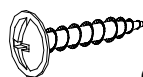

Q - 4 St.
3,5x16 mm

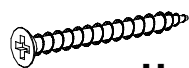

H - 6 St.
4x60 mm

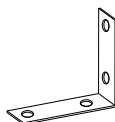

Y - 2 St.



I - 2 St.



M - 30 St.
3x30 mm

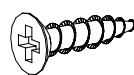

G - 2 St.
4x20 mm

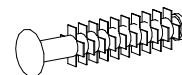

F - 8 St.

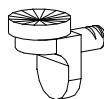

P - 13 St.



N - 4 St.
4x30 mm



U - 3 St.

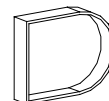

R - 3 St.



L - 12 St.

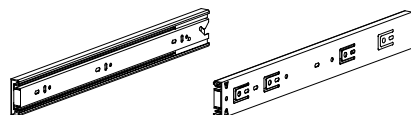

T - 2 Kpl.

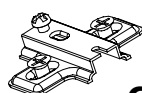

C - 3 St.

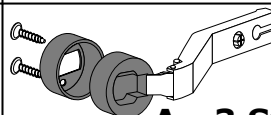

A - 3 St.



S - 1 St.



E - 60 St.

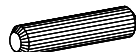

B - 20 St.

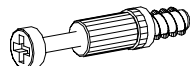

K - 12 St.

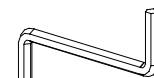

Z - 1 St.



J - 16 St.
5x13 mm

III

60X 

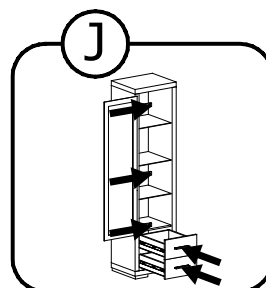
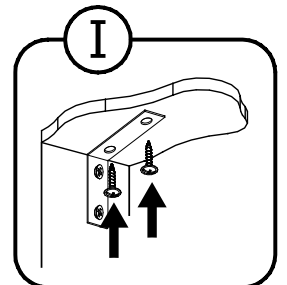
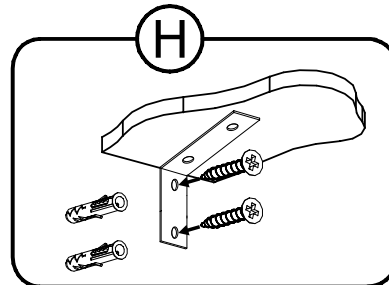
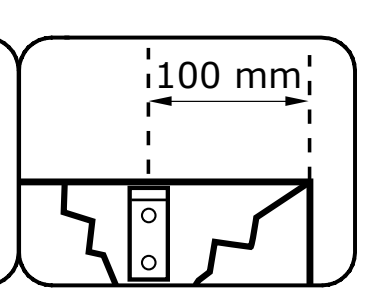
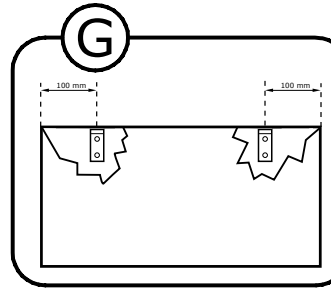
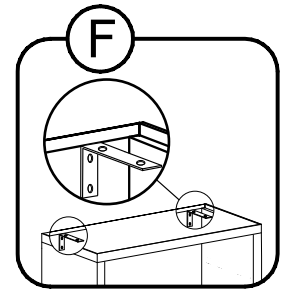
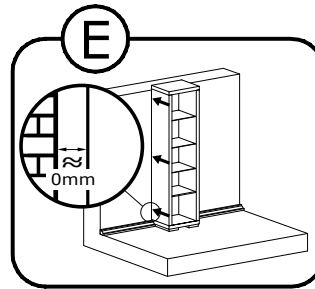
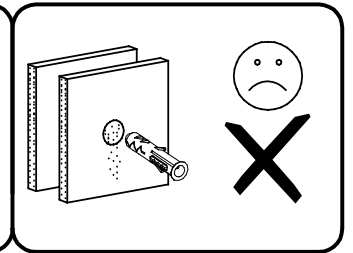
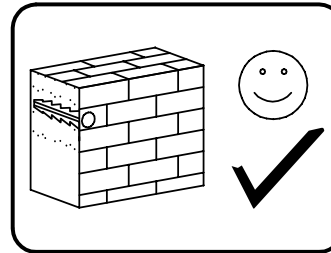
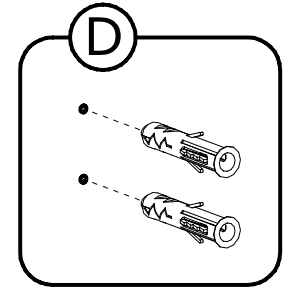
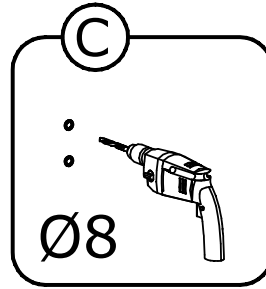
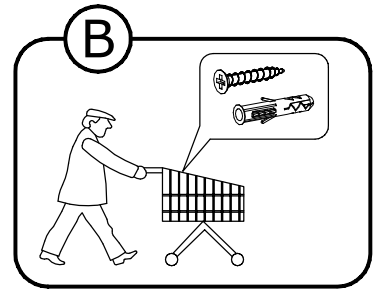
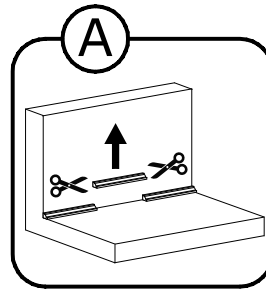
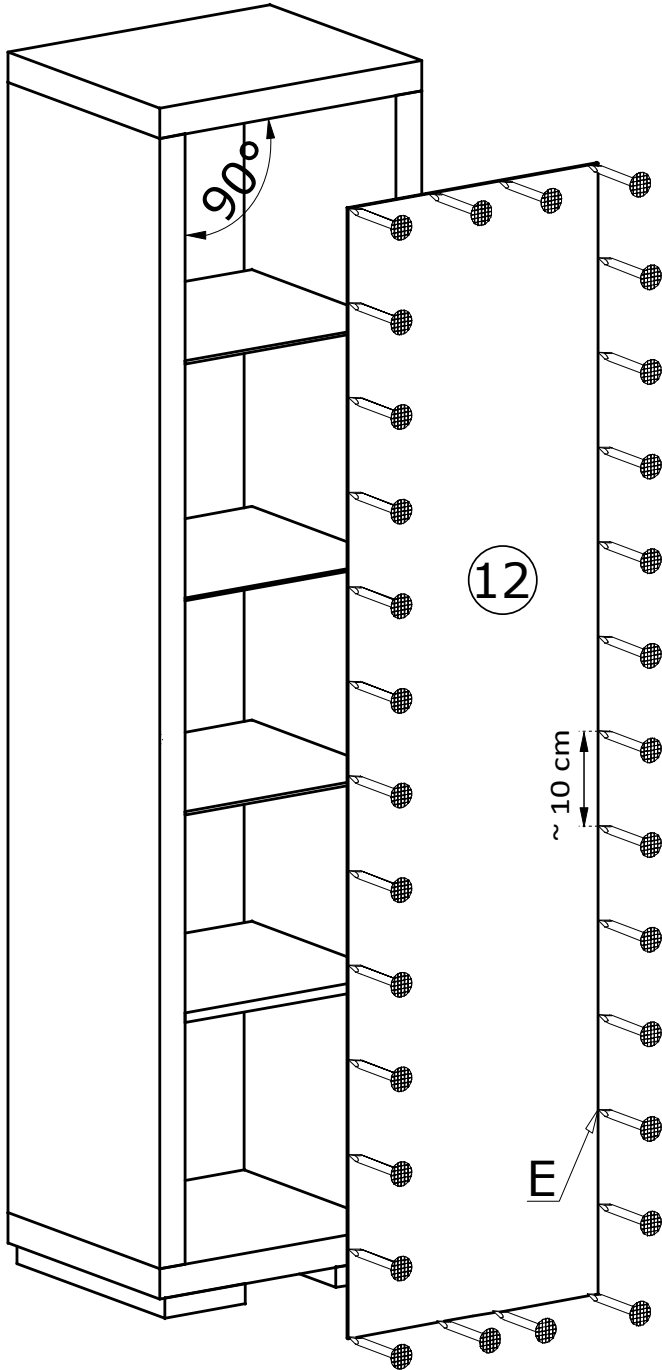

IV

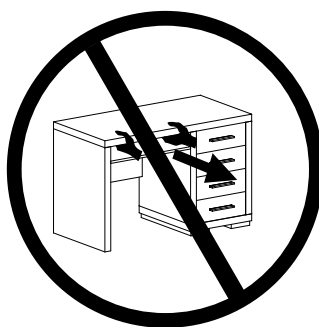
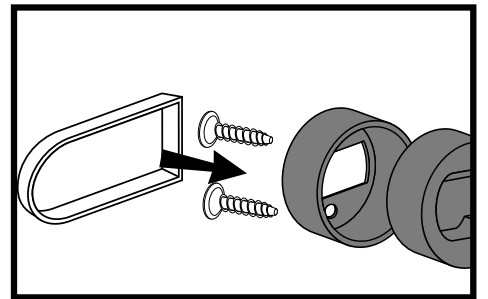
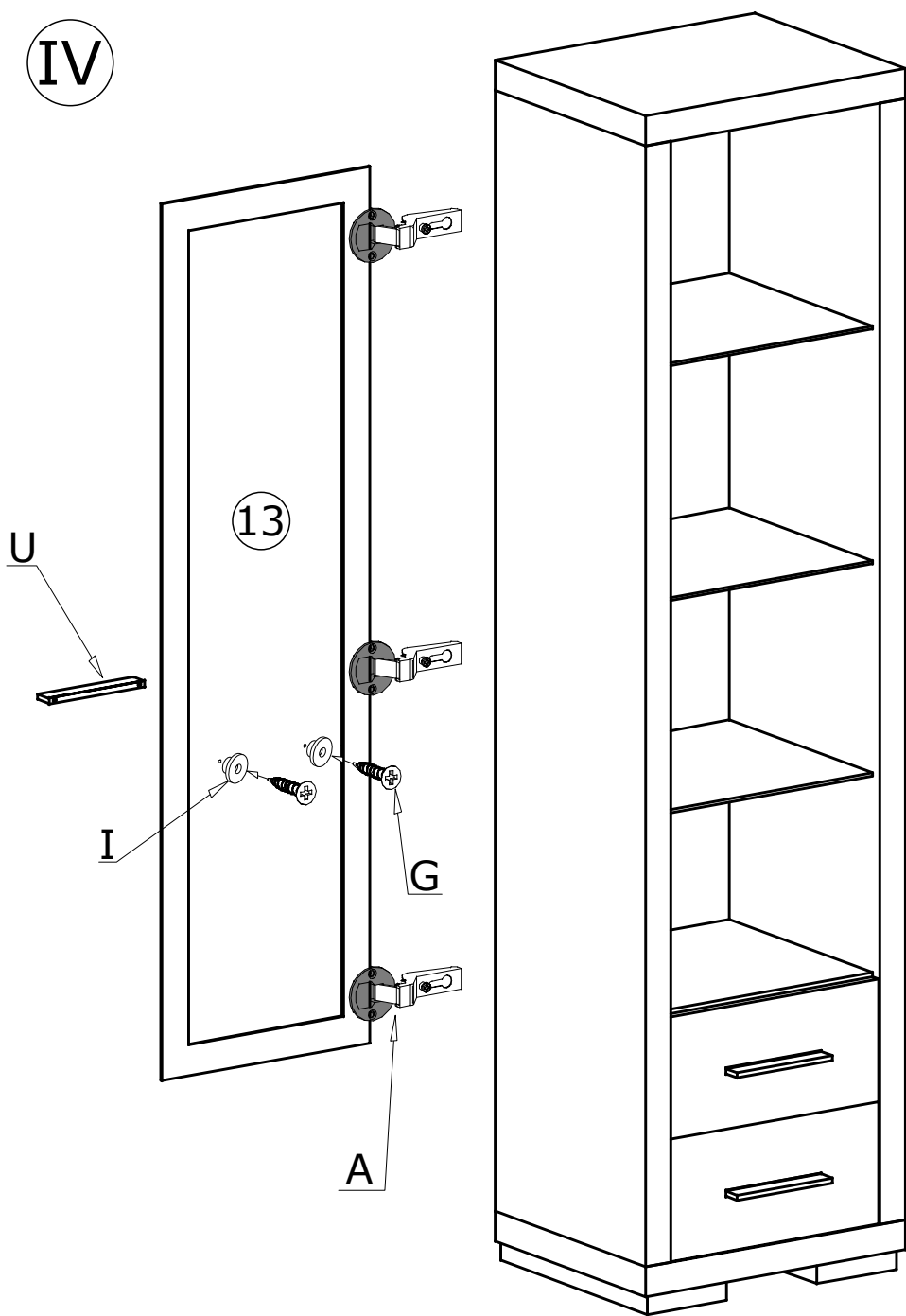

MONTAŻ/DEMONTAŻ PROWADNIC

1



2



3

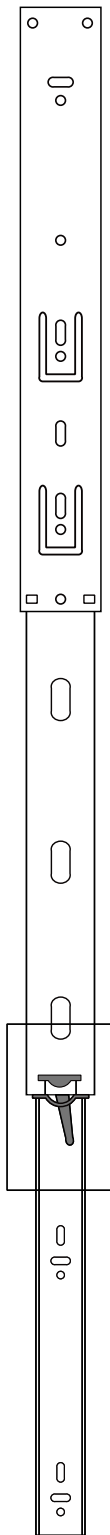

4

