

VEGAS 7

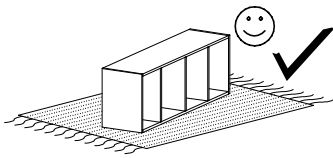

Narzędzia potrzebne do montażu

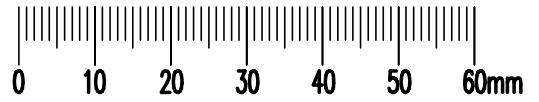
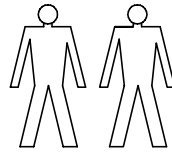
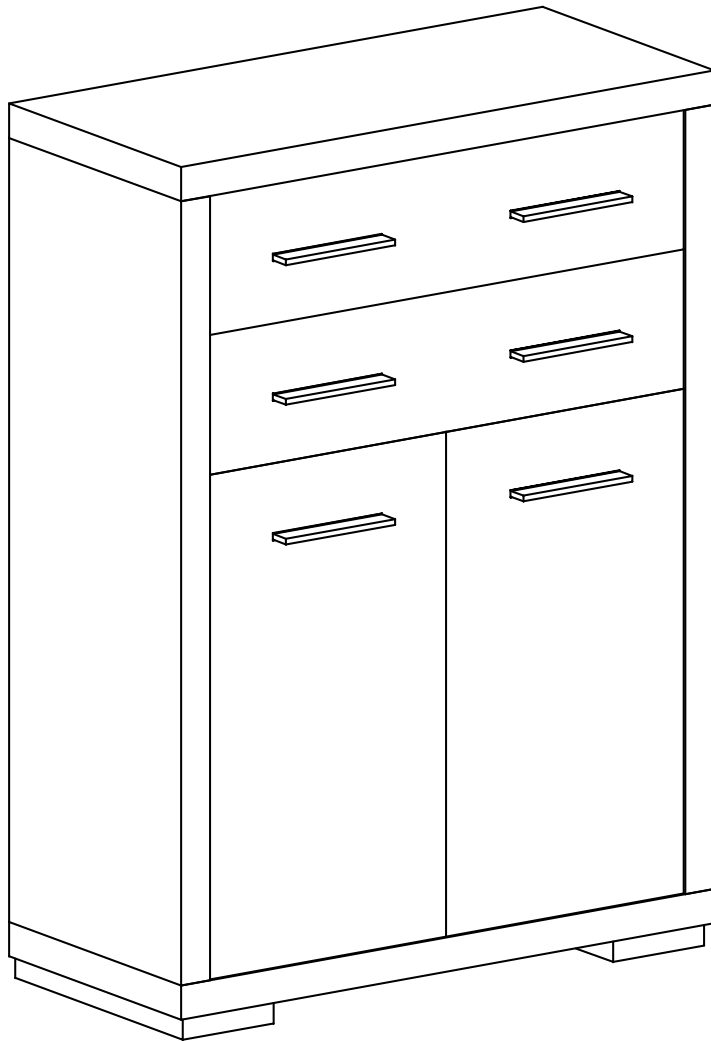
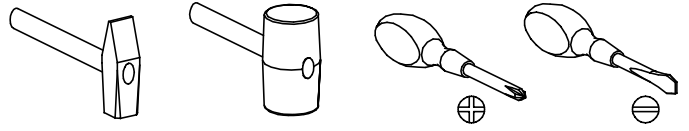

UWAGA !!!

MONTOWANIE USZKODZONYCH
ELEMENTÓW POWODUJE UTRATĘ
GWARANCJI

Nr	D[mm]	S[mm]	G[mm]	Ilość
1	883	407	48	1
2	883	407	48	1
3	1100	405	48	1
4	1100	405	48	1
5	848	388	16	1
6	780	190	16	2
7	350	165	16	2
8	726	165	16	2
9	350	165	16	2
10	757	355	2,5	2
11	870	790	2,5	1
12	700	388	16	2
13	700	388	16	2
14	870	360	2,5	1

W przypadku reklamacji proszę podać numer pakowacza znajdujący się na kartonie.

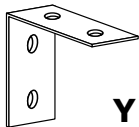

Y - 1 St.

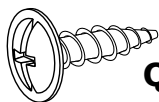

Q - 2 St.
3,5x16 mm

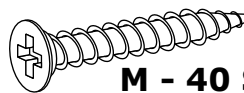

M - 40 St.
3x30 mm

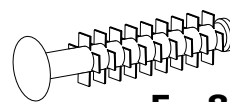

F - 8 St.



X2 - 16 St.

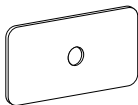

A - 6 St.

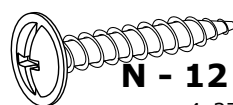

N - 12 St.
4x27 mm

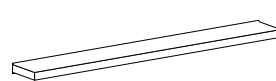

U - 6 St.

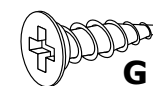

G - 14 St.
3,5x16 mm



H - 6 St.
4x60 mm

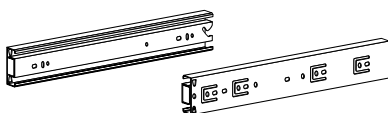

T - 2 Kpl.

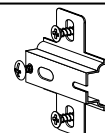

C - 4 St.

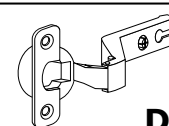

D - 4 St.



L - 16 St.



E - 50 St.

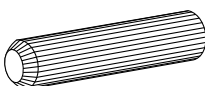

B - 20 St.

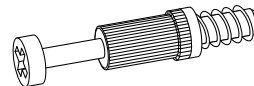

K - 16 St.

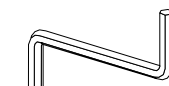

Z - 1 St.

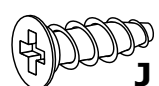

J - 16 St.
5x13 mm

I

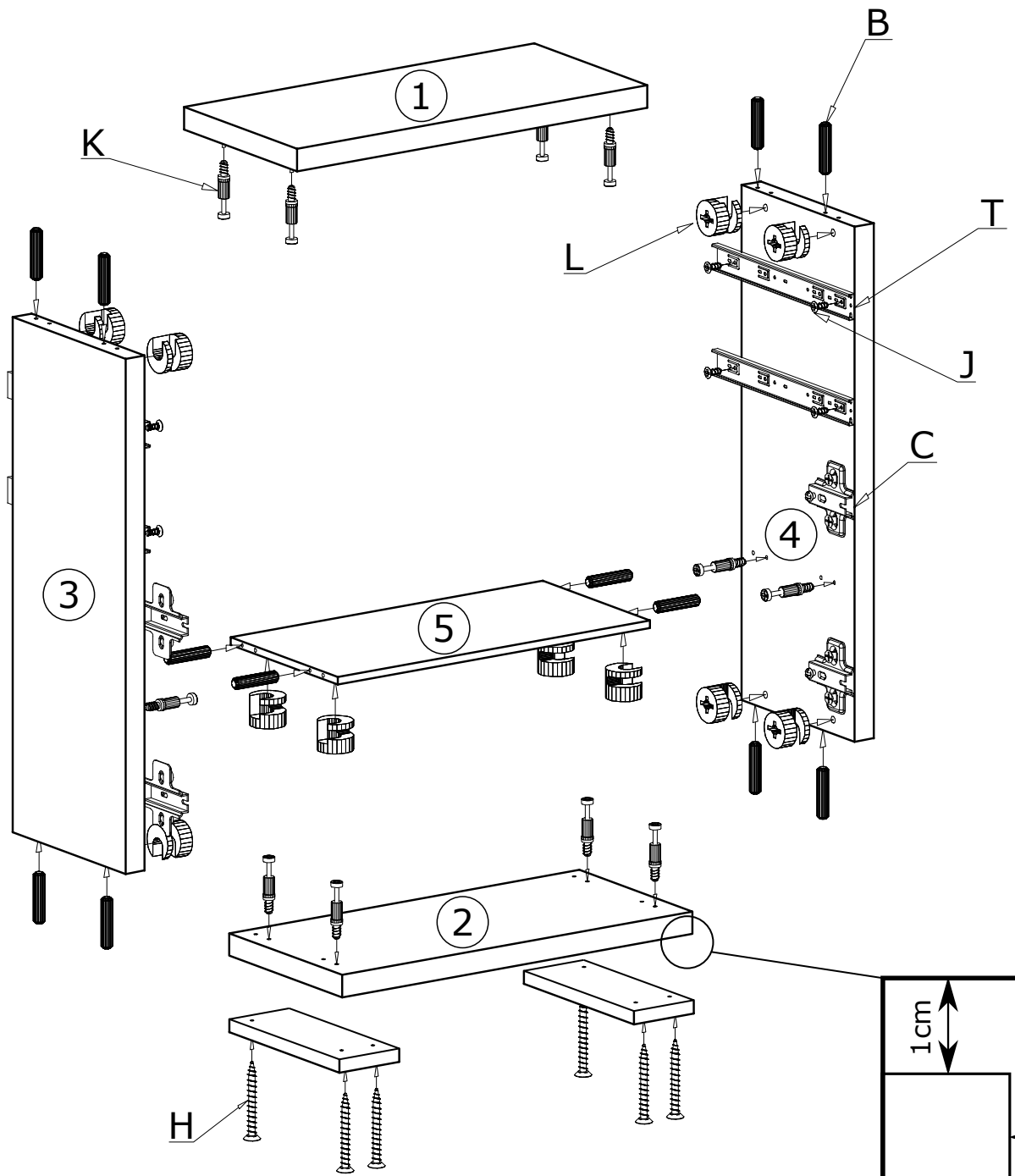

II

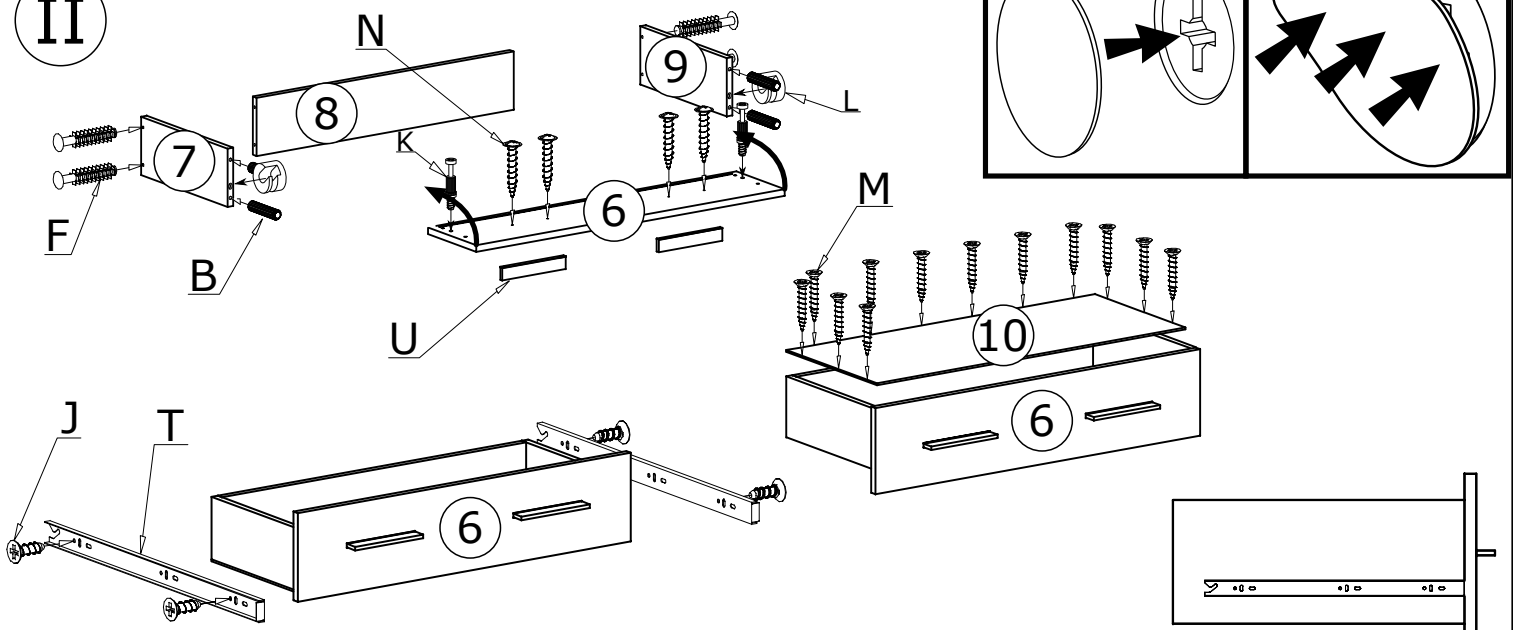

III

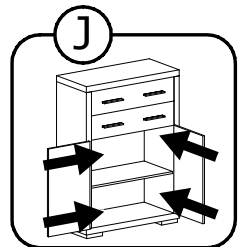
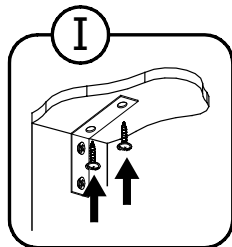
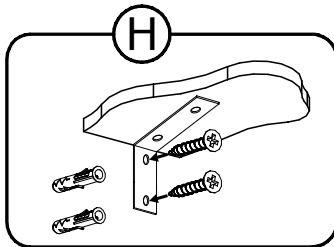
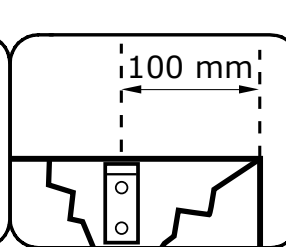
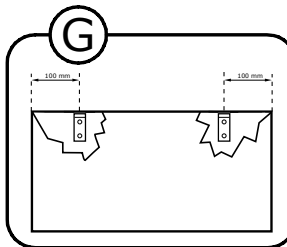
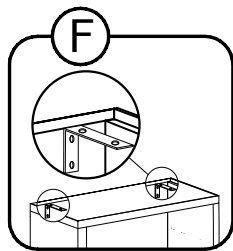
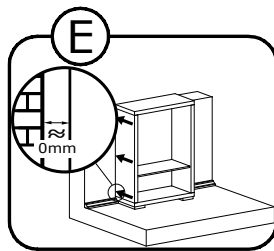
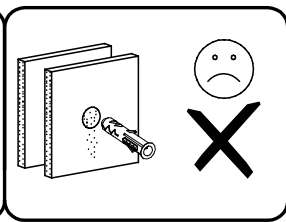
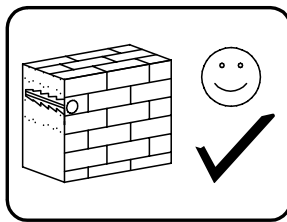
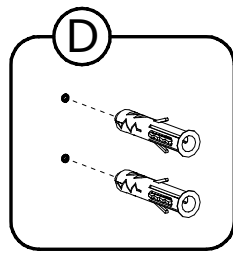
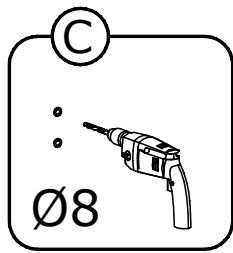
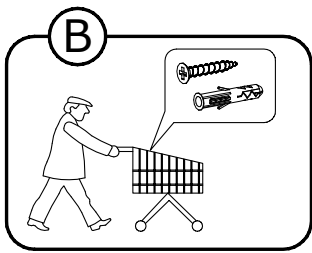
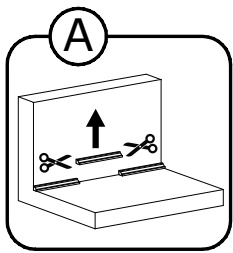
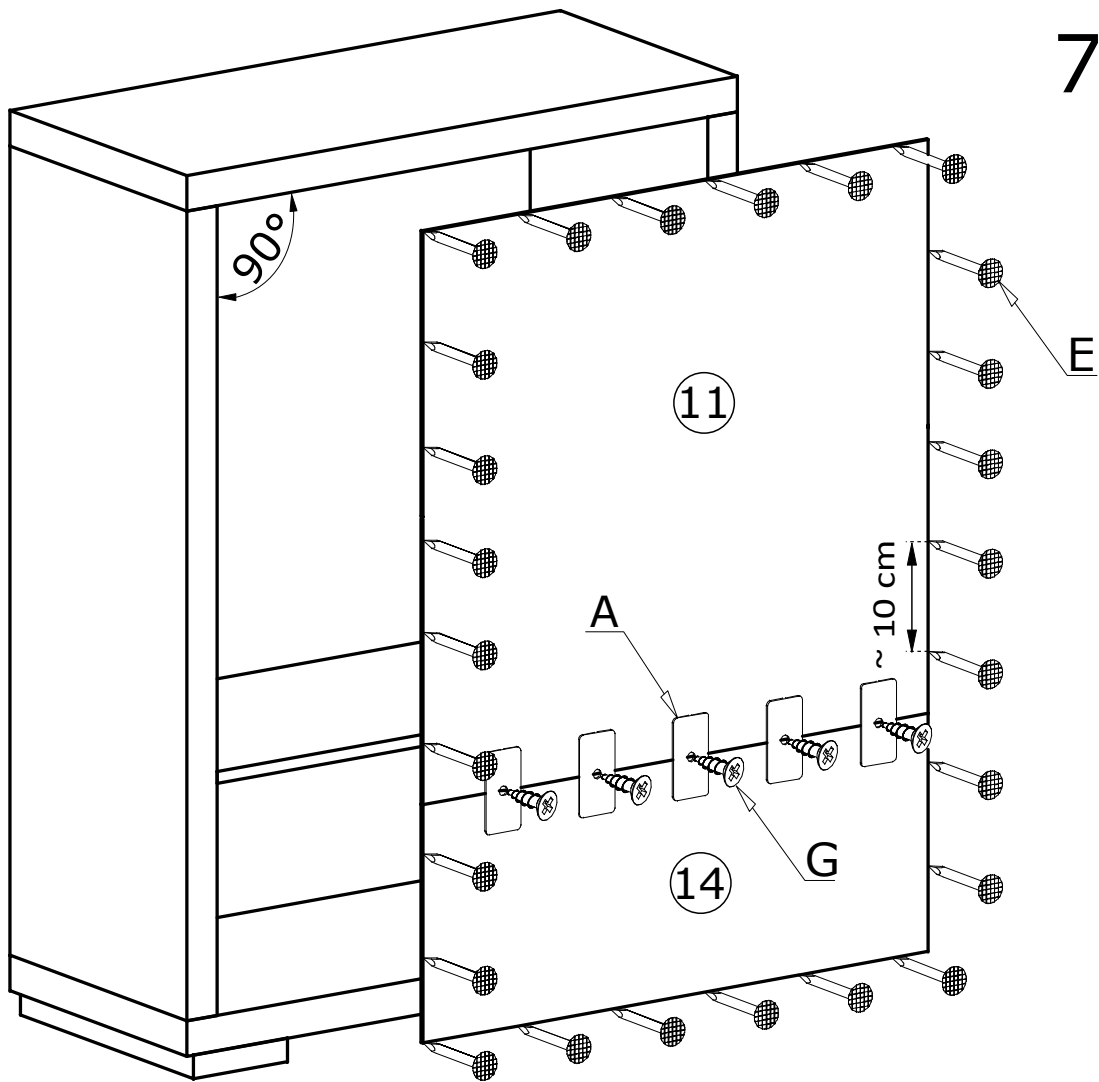

IV

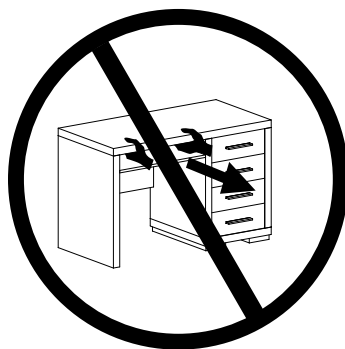
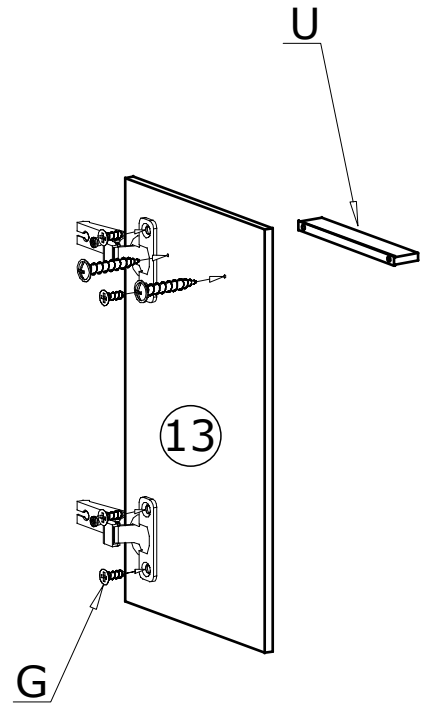
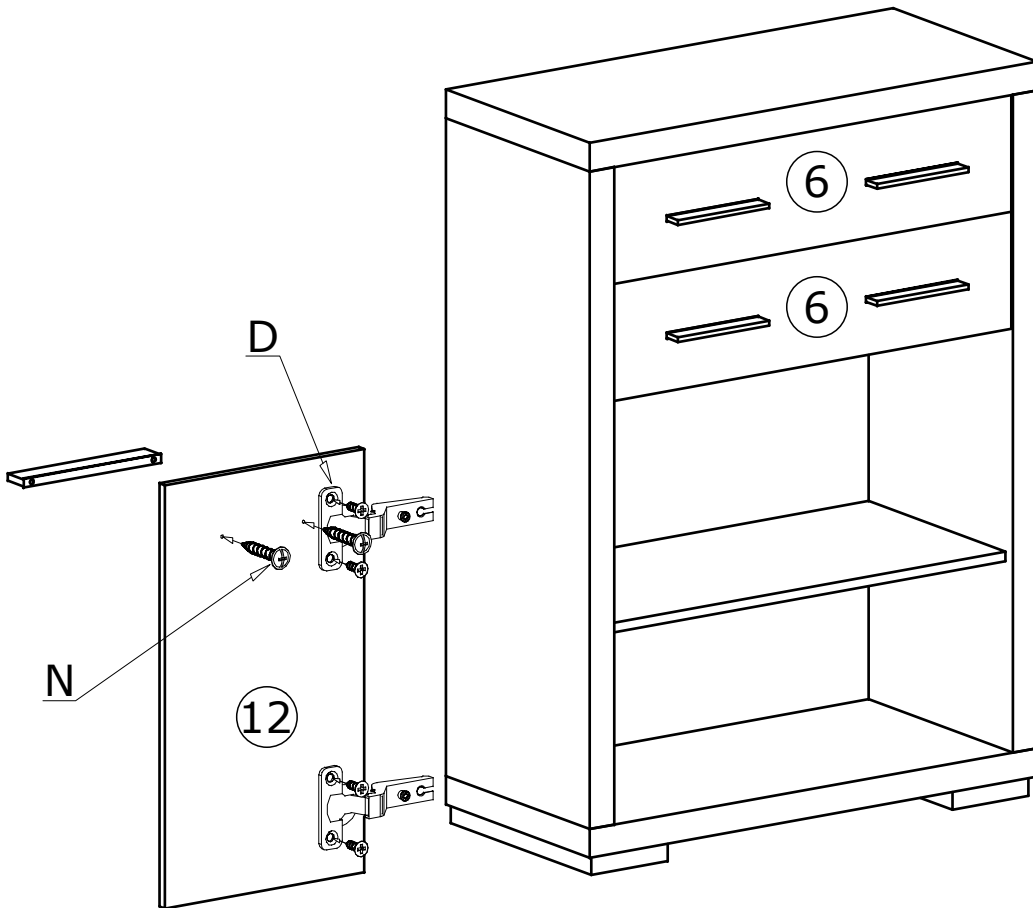
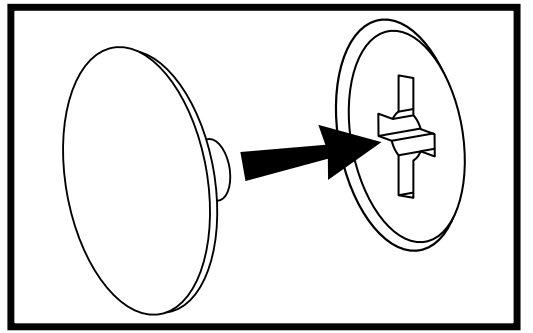

MONTAŻ/DEMONTAŻ PROWADNIC

1



2

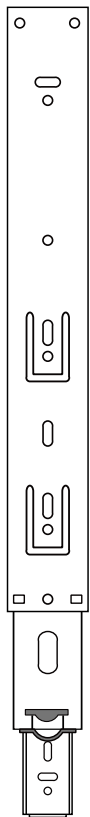

3

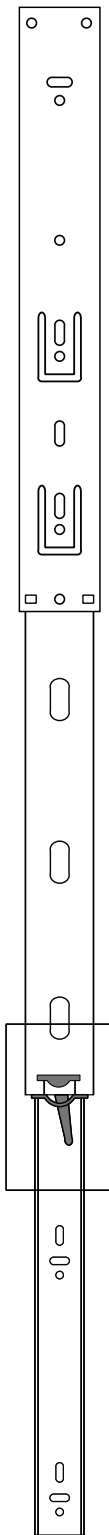

4

