

# VEGAS 3

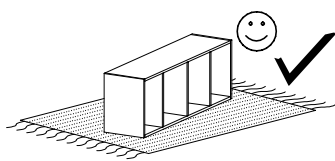

Narzędzia potrzebne do montażu

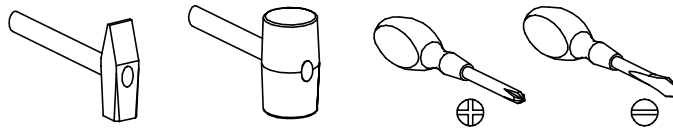

## UWAGA !!!

MONTOWANIE USZKODZONYCH  
ELEMENTÓW POWODUJE UTRATĘ  
GWARANCJI

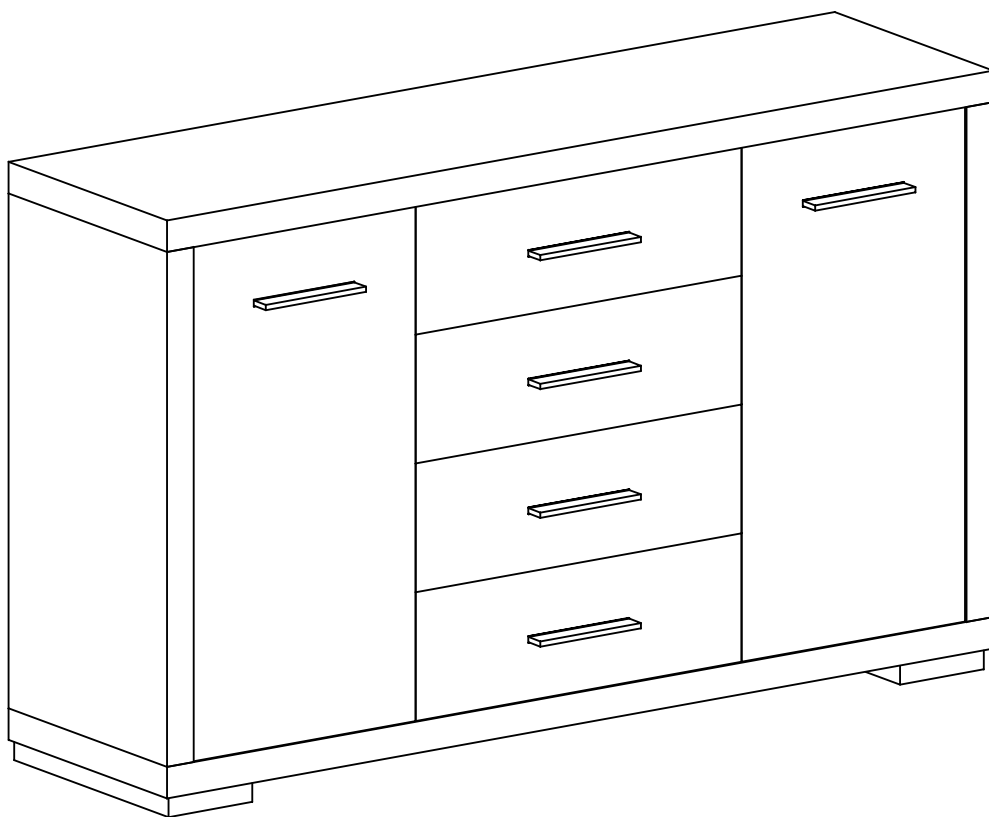

Nr	D[mm]	S[mm]	G[mm]	Ilość
1	1483	407	48	1
2	1483	407	48	1
3	780	405	48	1
4	780	388	16	1
5	780	388	16	1
6	780	405	48	1
7	398	320	16	2
8	1470	834	2,5	1
9	773	368	16	1
10	773	368	16	1
11	590	355	2,5	4
12	635	190	16	4
13	350	165	16	4
14	350	165	16	4
15	559	165	16	4

W przypadku reklamacji proszę podać numer pakowacza znajdujący się na kartonie.

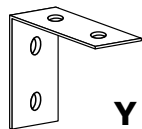

**Y - 1 St.**

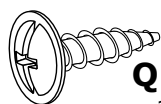

**Q - 2 St.**  
3,5x16 mm

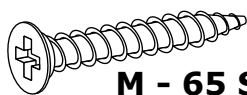

**M - 65 St.**  
3x30 mm

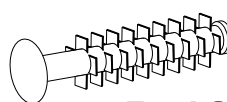

**F - 16 St.**



**X2 - 24 St.**

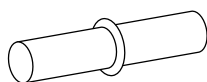

**P - 8 St.**

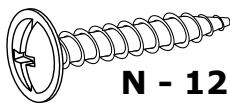

**N - 12 St.**  
4x27 mm

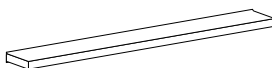

**U - 6 St.**

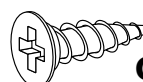

**G - 8 St.**  
3,5x16 mm

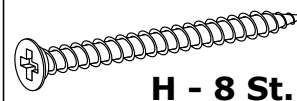

**H - 8 St.**  
4x60 mm

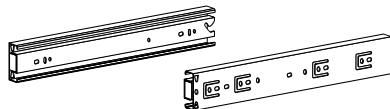

**T - 4 Kpl.**

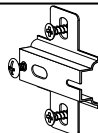

**C - 4 St.**

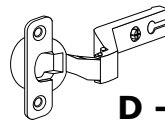

**D - 4 St.**

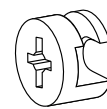

**L - 24 St.**



**E - 50 St.**

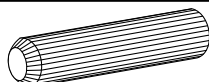

**B - 32 St.**

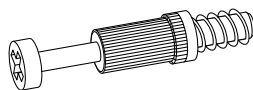

**K - 24 St.**

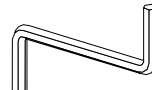

**Z - 1 St.**



**J - 32 St.**  
5x13 mm

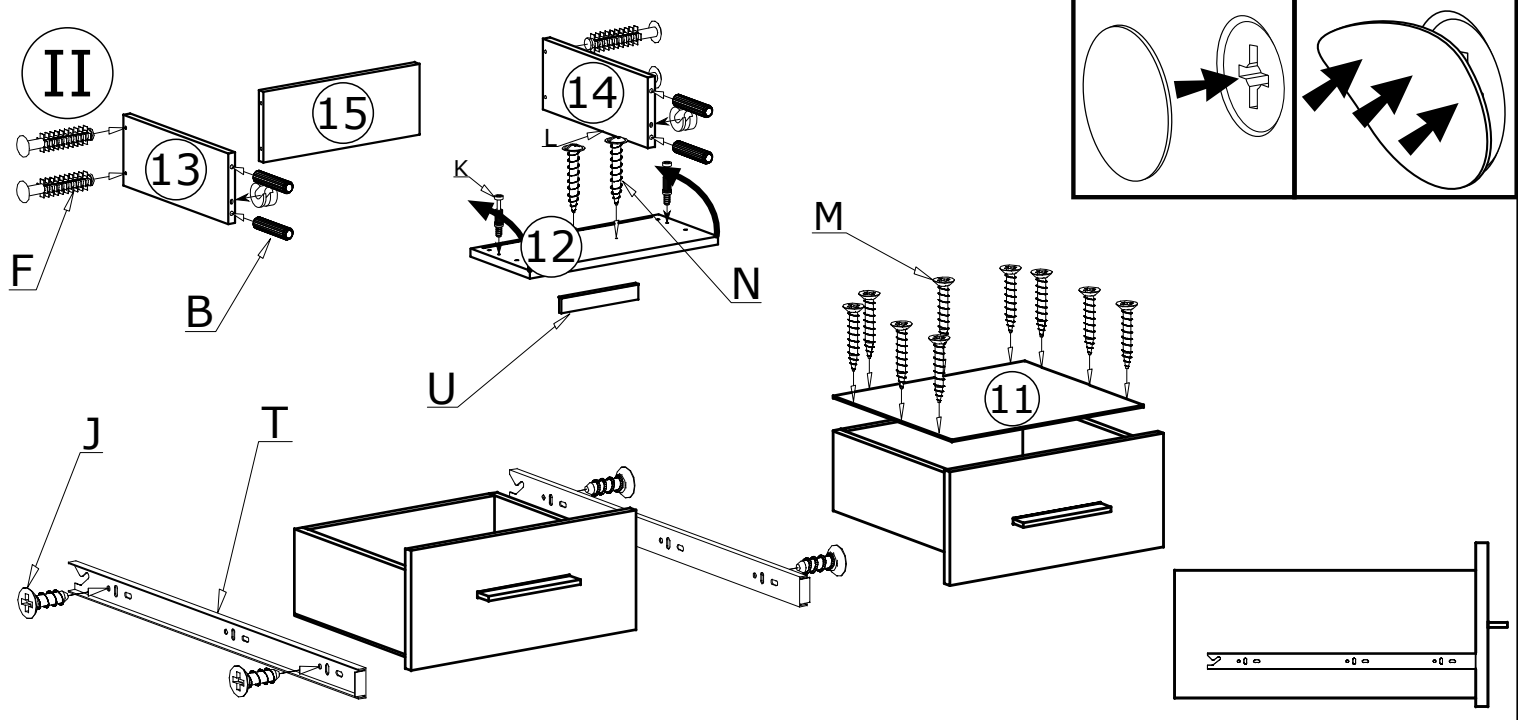
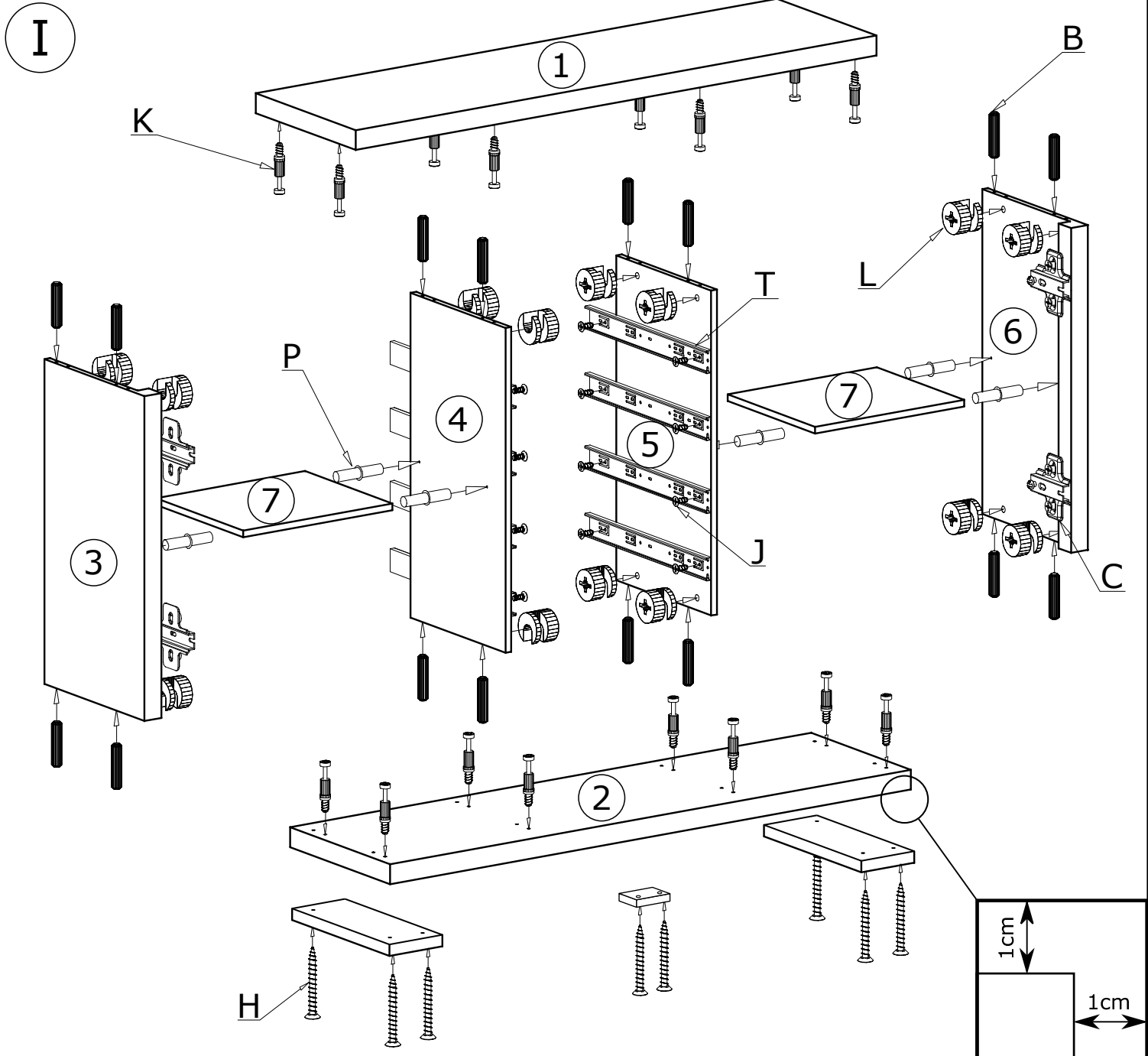

III

50X 

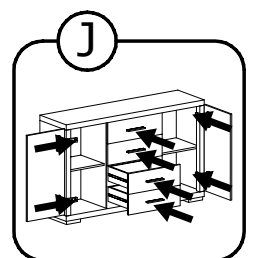
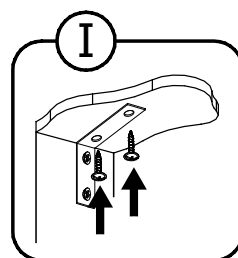
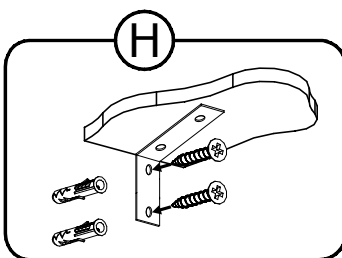
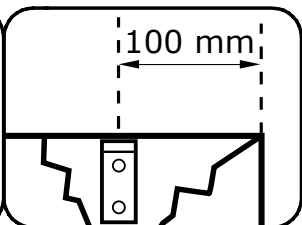
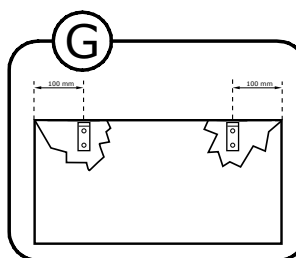
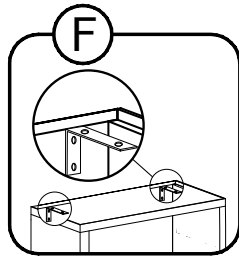
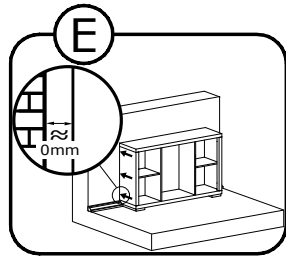
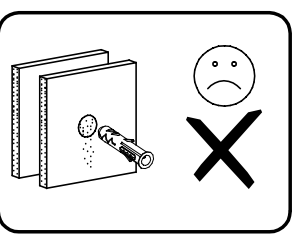
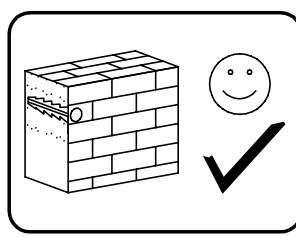
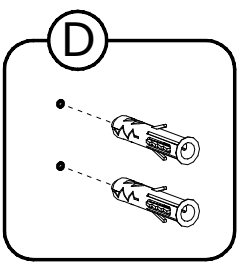
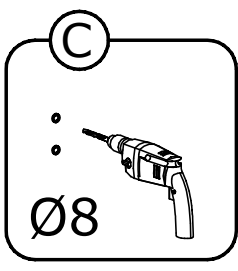
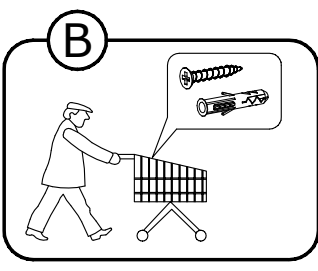
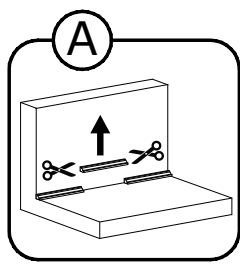
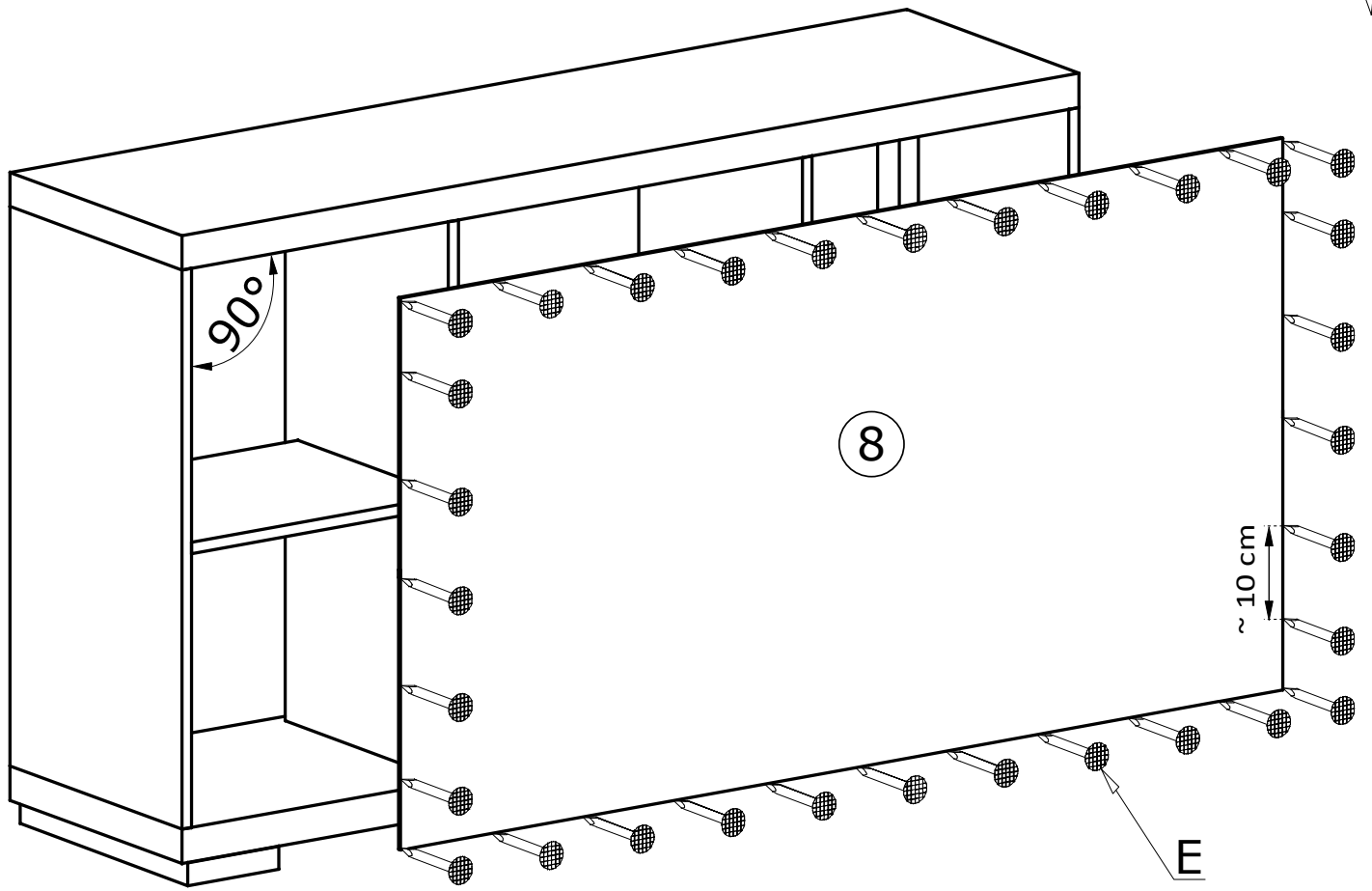

IV

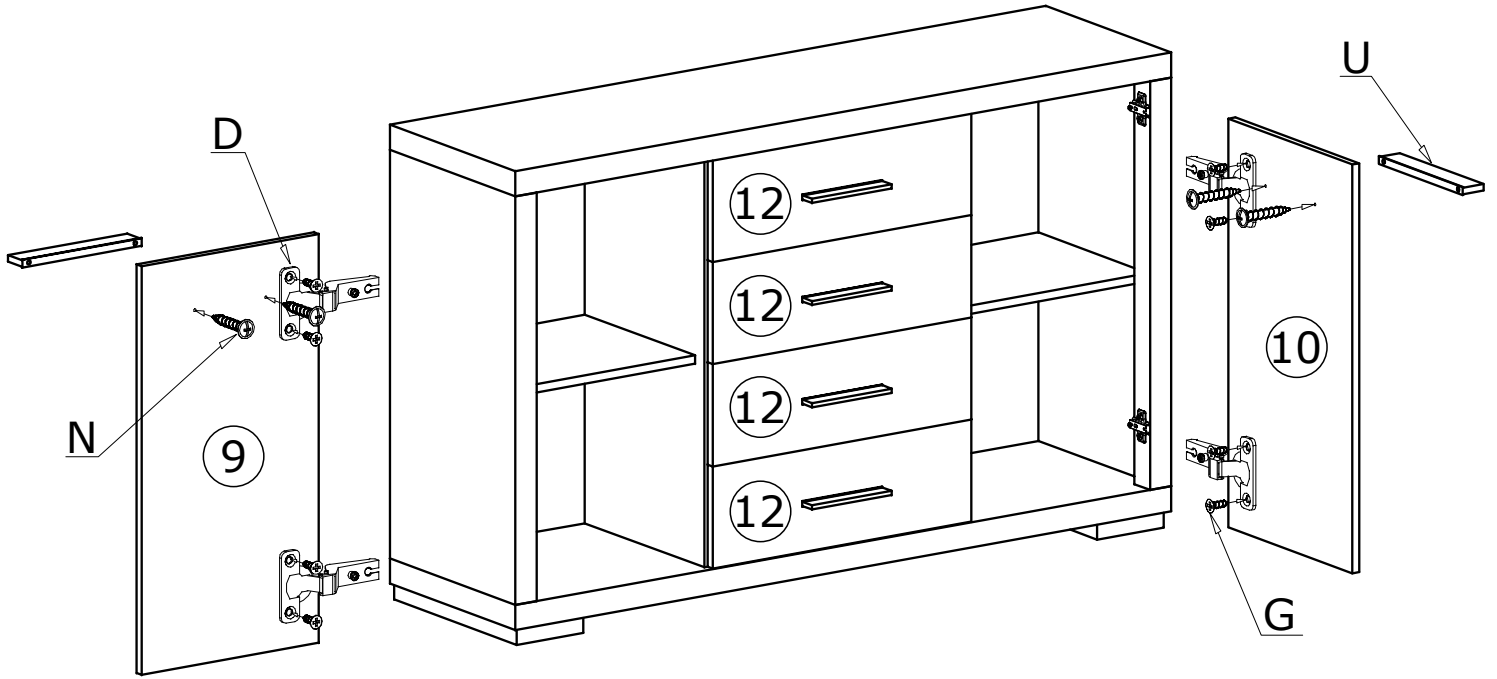
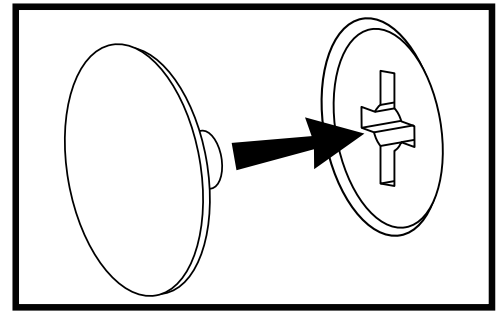

# MONTAŻ/DEMONTAŻ PROWADNIC

1



2

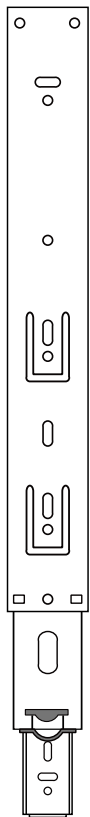

3

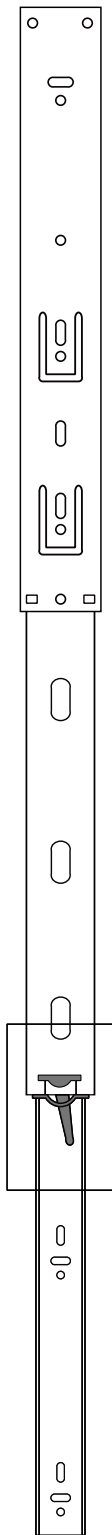

4

