

VEGAS 2

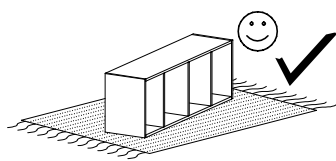

Narzędzia potrzebne do montażu

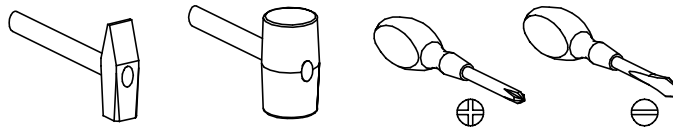

UWAGA !!!

**MONTOWANIE USZKODZONYCH
ELEMENTÓW POWODUJE UTRATĘ
GWARANCJI**

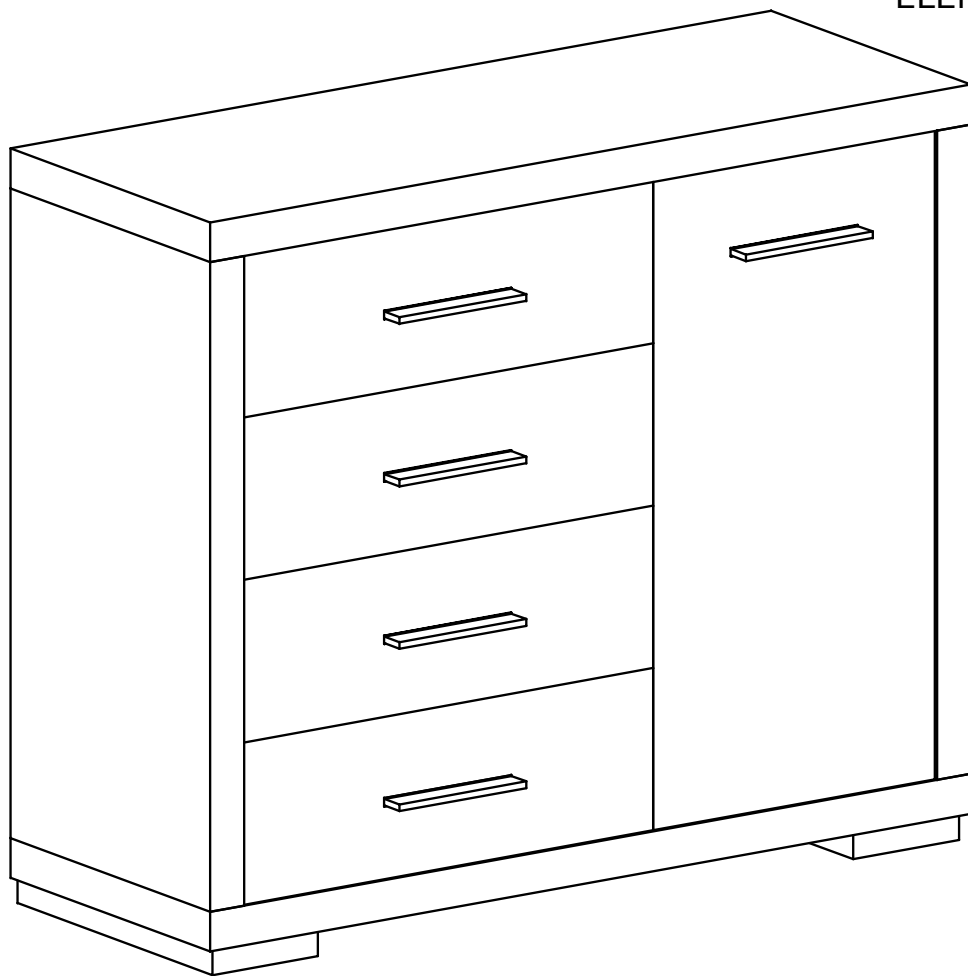

Nr	D[mm]	S[mm]	G[mm]	Ilość
1	1082	407	48	1
2	1082	407	48	1
3	783	405	48	1
4	780	388	16	1
5	783	405	48	1
6	394	320	16	1
7	773	368	16	1
8	1070	834	2,5	1
9	603	190	16	4
10	546	165	16	4
11	350	165	16	4
12	350	165	16	4
13	575	355	2,5	4

W przypadku reklamacji proszę podać numer pakowacza znajdujący się na kartonie.

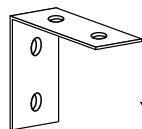

Y - 1 St.

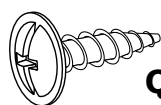

Q - 2 St.
3,5x16 mm

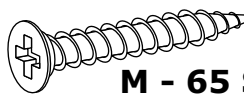

M - 65 St.
3x30 mm

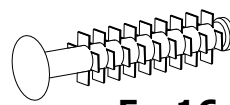

F - 16 St.



X2 - 20 St.

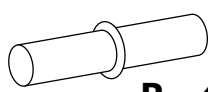

P - 4 St.

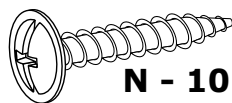

N - 10 St.
4x27 mm



U - 5 St.

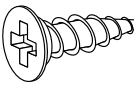

G - 4 St.
3,5x16 mm



H - 6 St.
4x60 mm

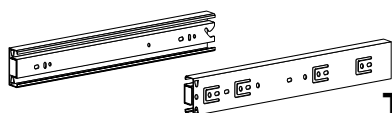

T - 4 Kpl.

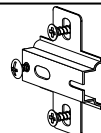

C - 2 St.

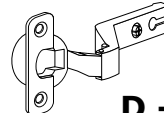

D - 2 St.

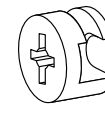

L - 20 St.

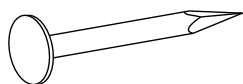

E - 55 St.

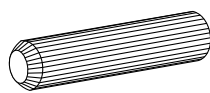

B - 28 St.

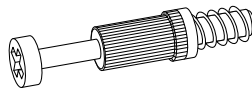

K - 20 St.



Z - 1 St.

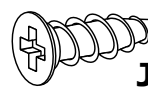

J - 32 St.
5x13 mm

I

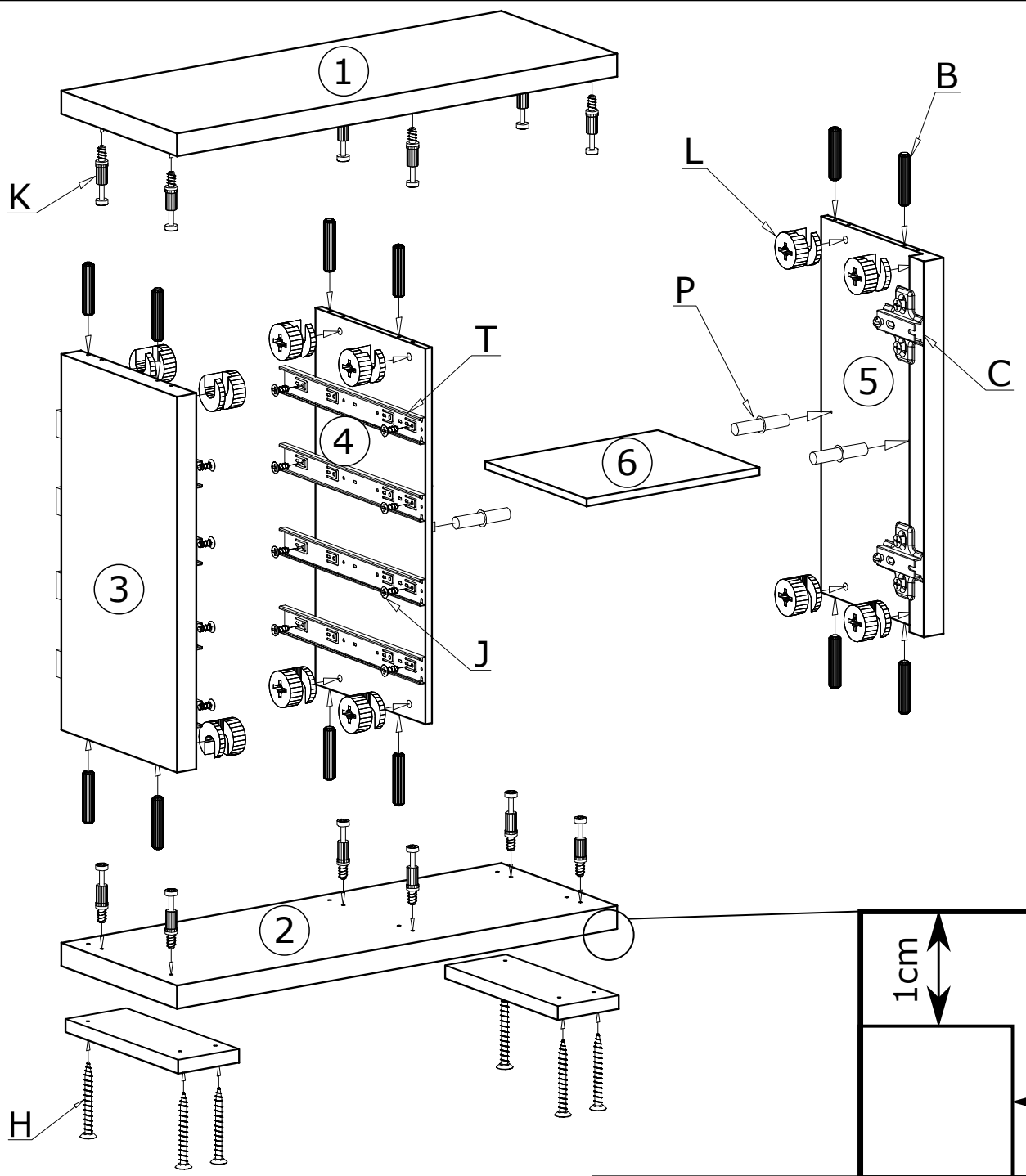

II

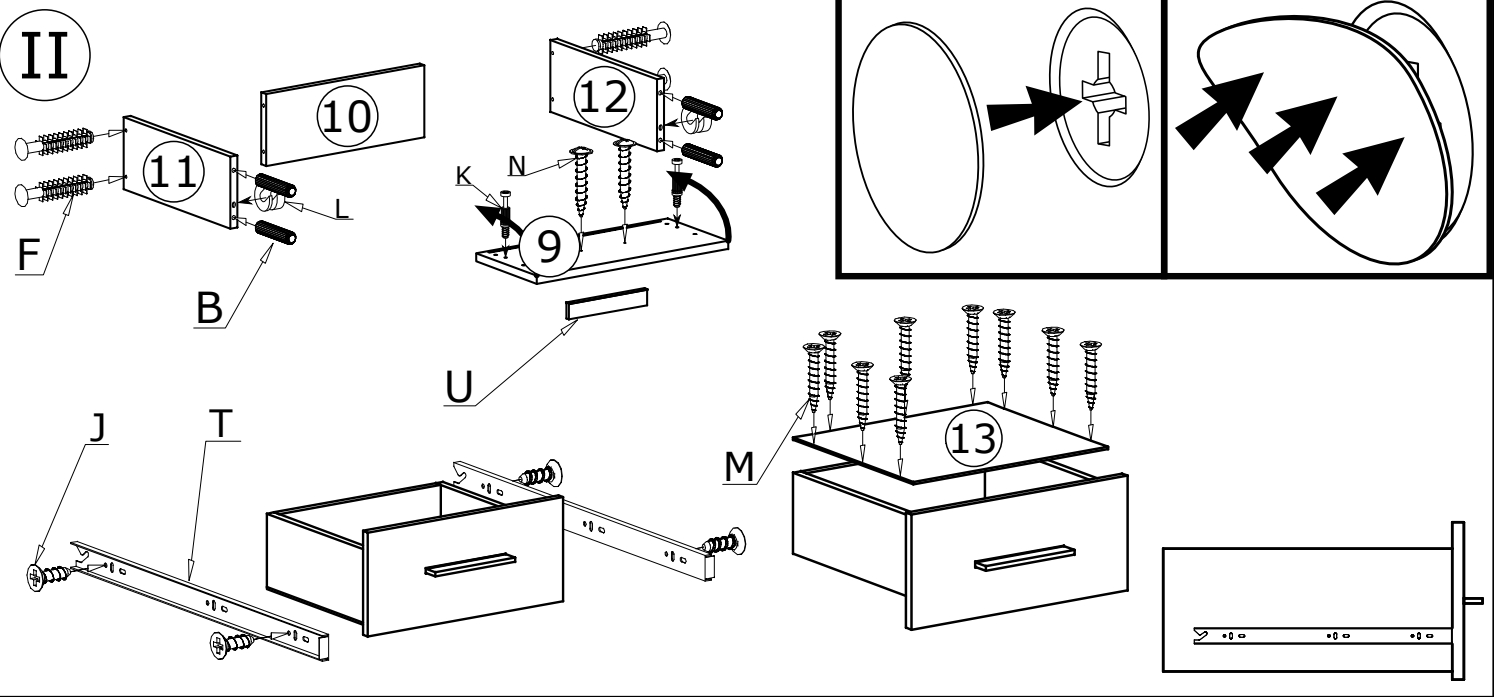

III

55X 

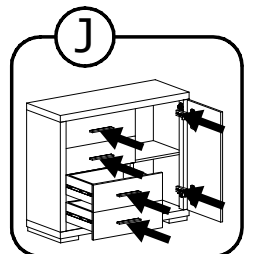
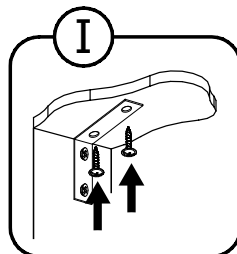
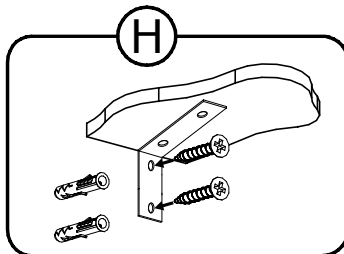
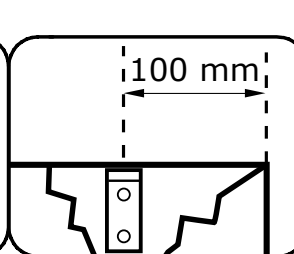
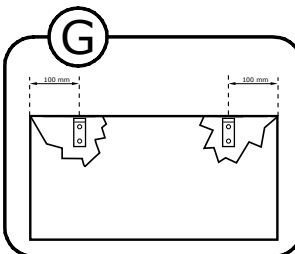
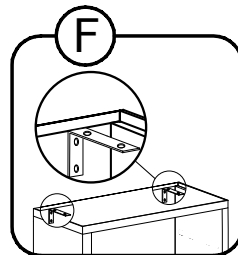
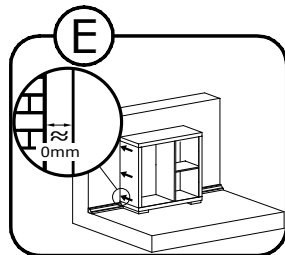
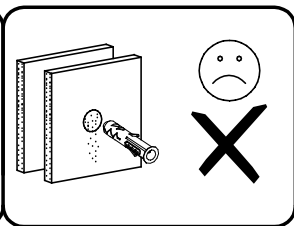
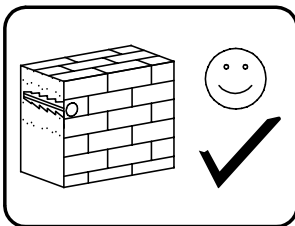
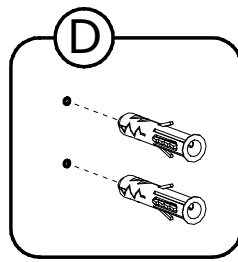
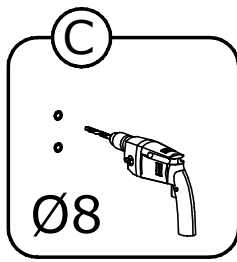
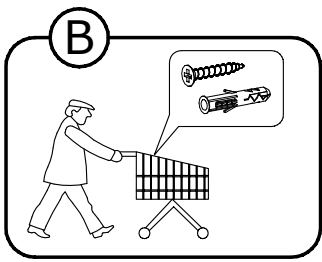
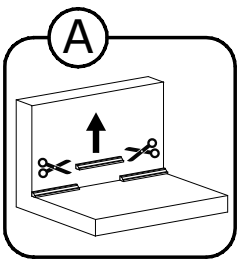
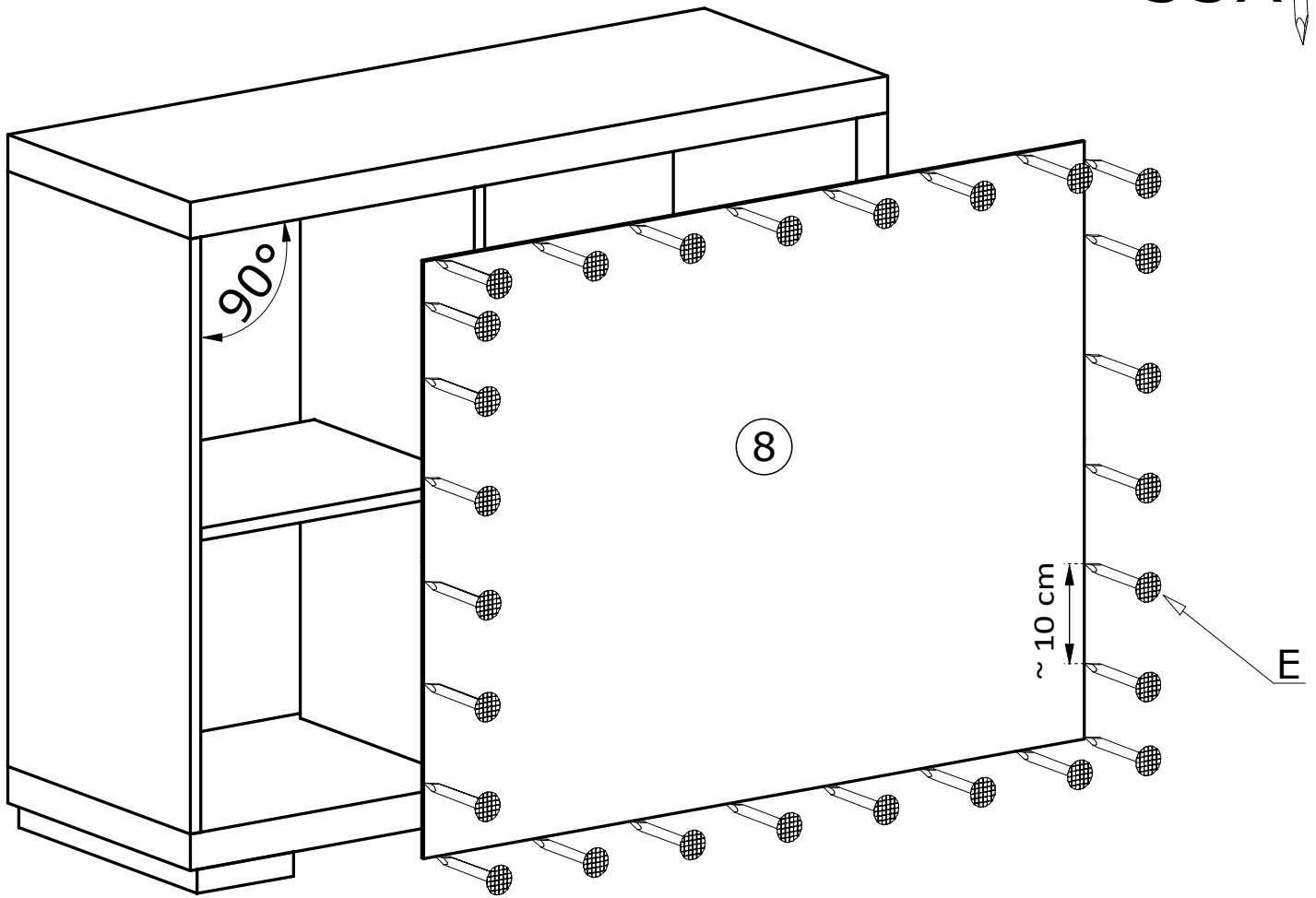

IV

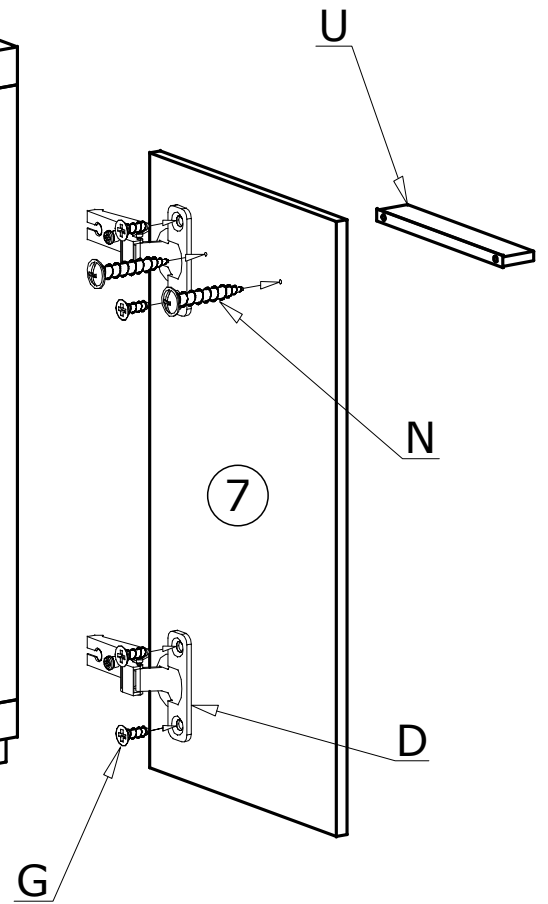
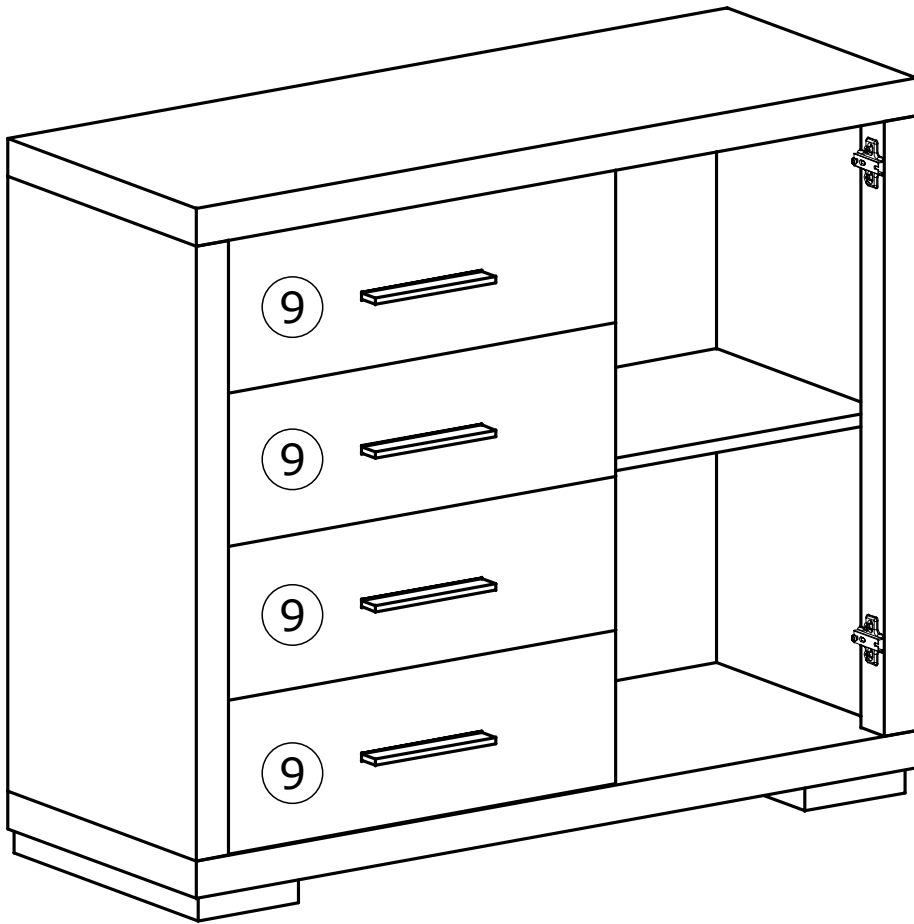
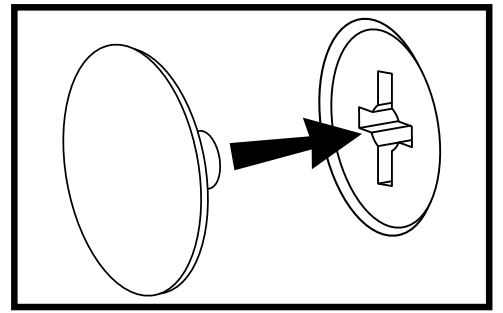

MONTAŻ/DEMONTAŻ PROWADNIC

1

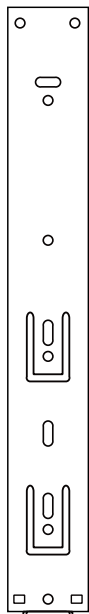

2

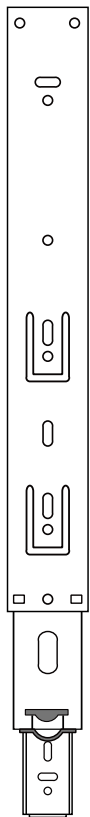

3

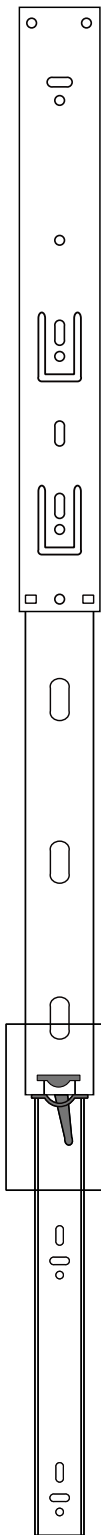

4

