

TADEUSZ 24

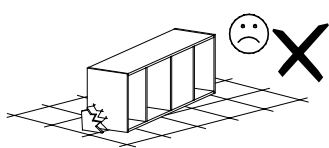

Narzędzia potrzebne do montażu

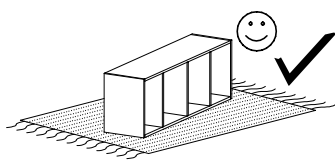
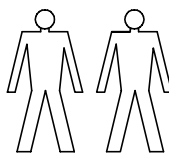
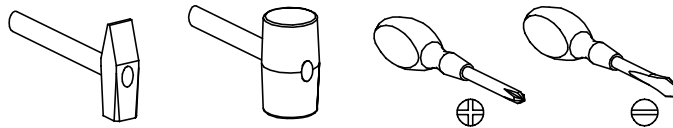

UWAGA !!!

MONTOWANIE USZKODZONYCH
ELEMENTÓW POWODUJE UTRATĘ
GWARANCJI

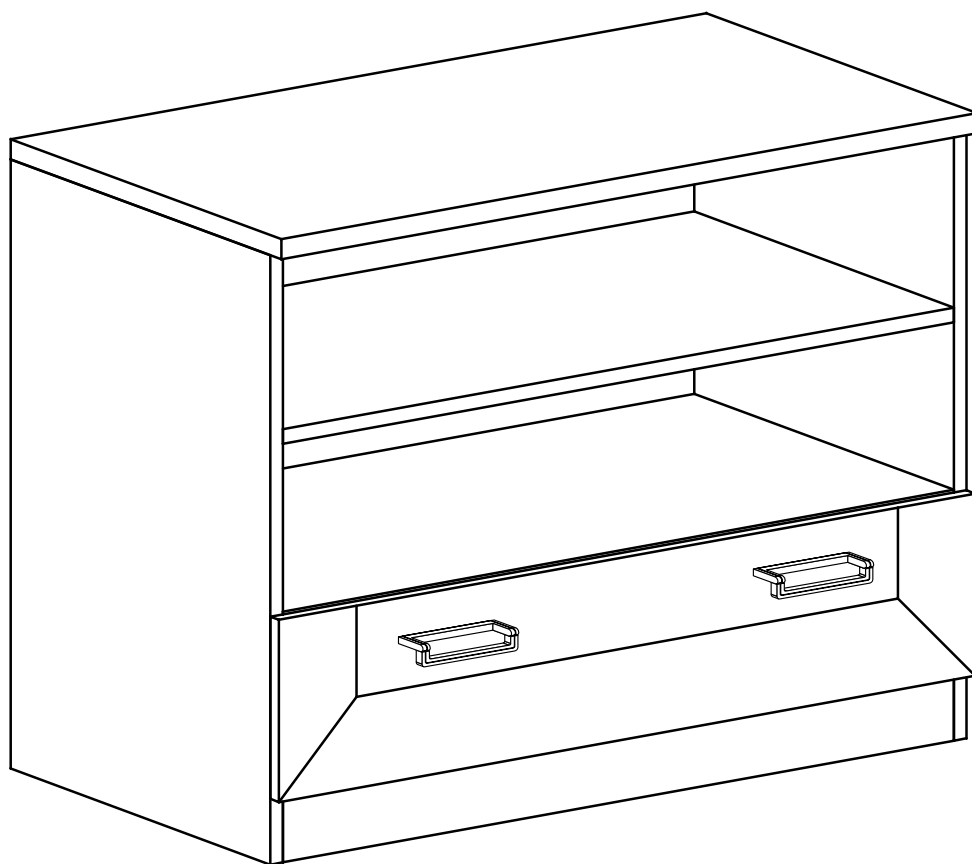

Nr	D[mm]	S[mm]	G[mm]	Ilość
1	880	495	32	1
2	832	460	16	1
3	832	460	16	1
4	660	460	16	1
5	660	460	16	1
6	832	80	16	1
7	832	460	16	1
8	775	150	16	1
9	450	150	16	1
10	450	150	16	1
11	862	190	16	1
12	805	455	2,5	1
13	855	607	2,5	1

W przypadku reklamacji proszę podać numer pakowacza znajdujący się na kartonie.

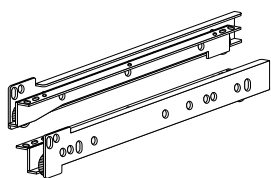

T - 1 Kpl.

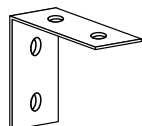

Y - 1 St.

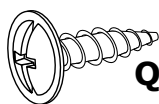

Q - 2 St.
3,5x16 mm



X1 - 6 St.

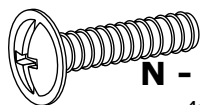

N - 4 St.
4x22 mm



U - 2 St.

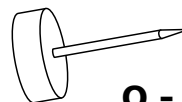

Q - 5 St.



X2 - 9 St.



F - 4 St.

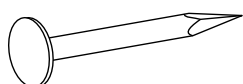

E - 40 St.

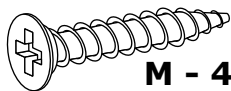

M - 4 St.
3,5x25 mm

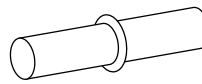

P - 4 St.

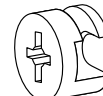

L - 6 St.

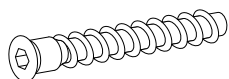

R - 9 St.

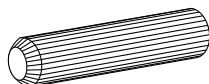

B - 20 St.

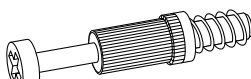

K - 6 St.

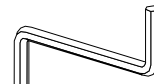

Z - 1 St.

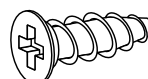

J - 4 St.
5x13 mm

I

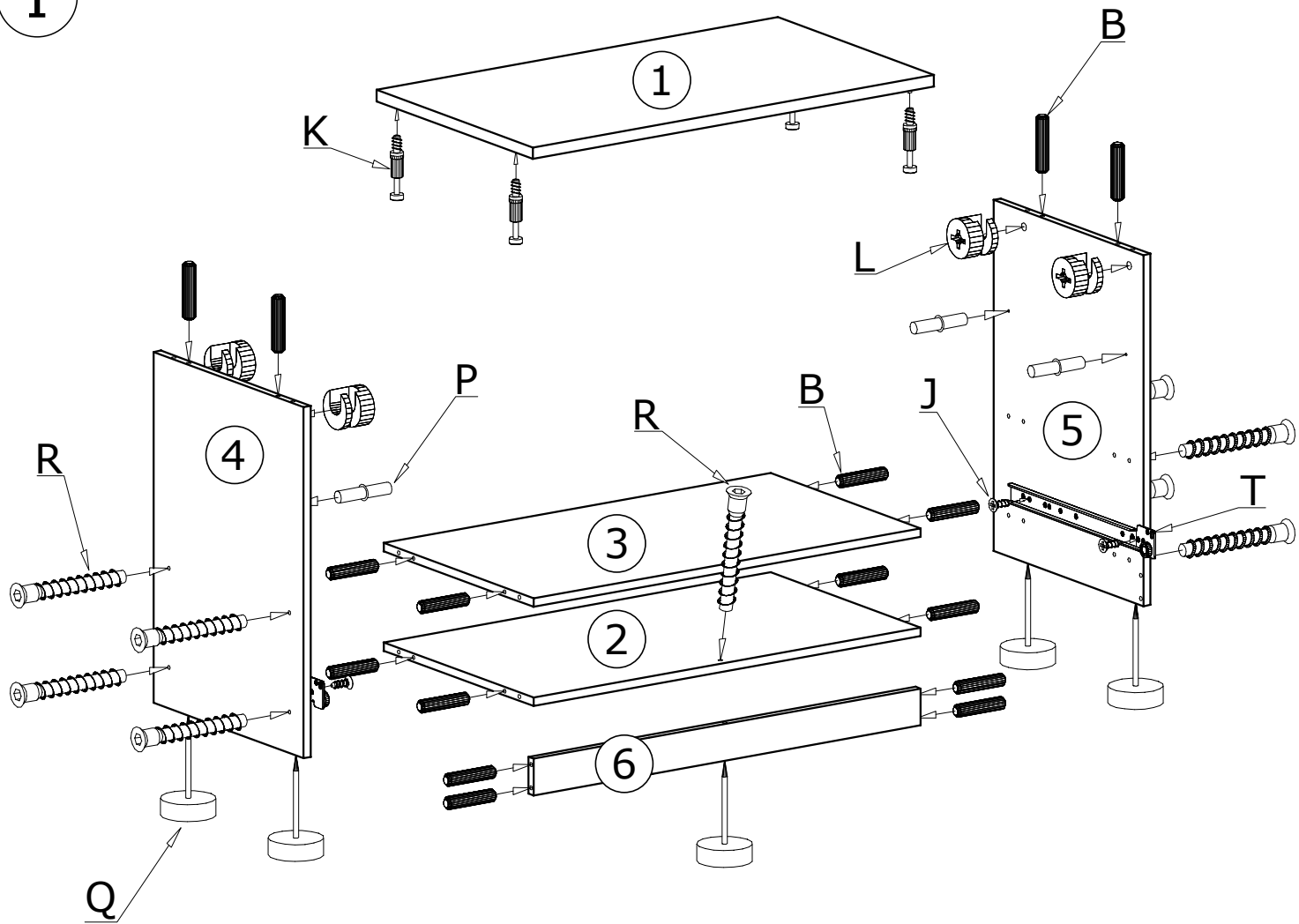

II

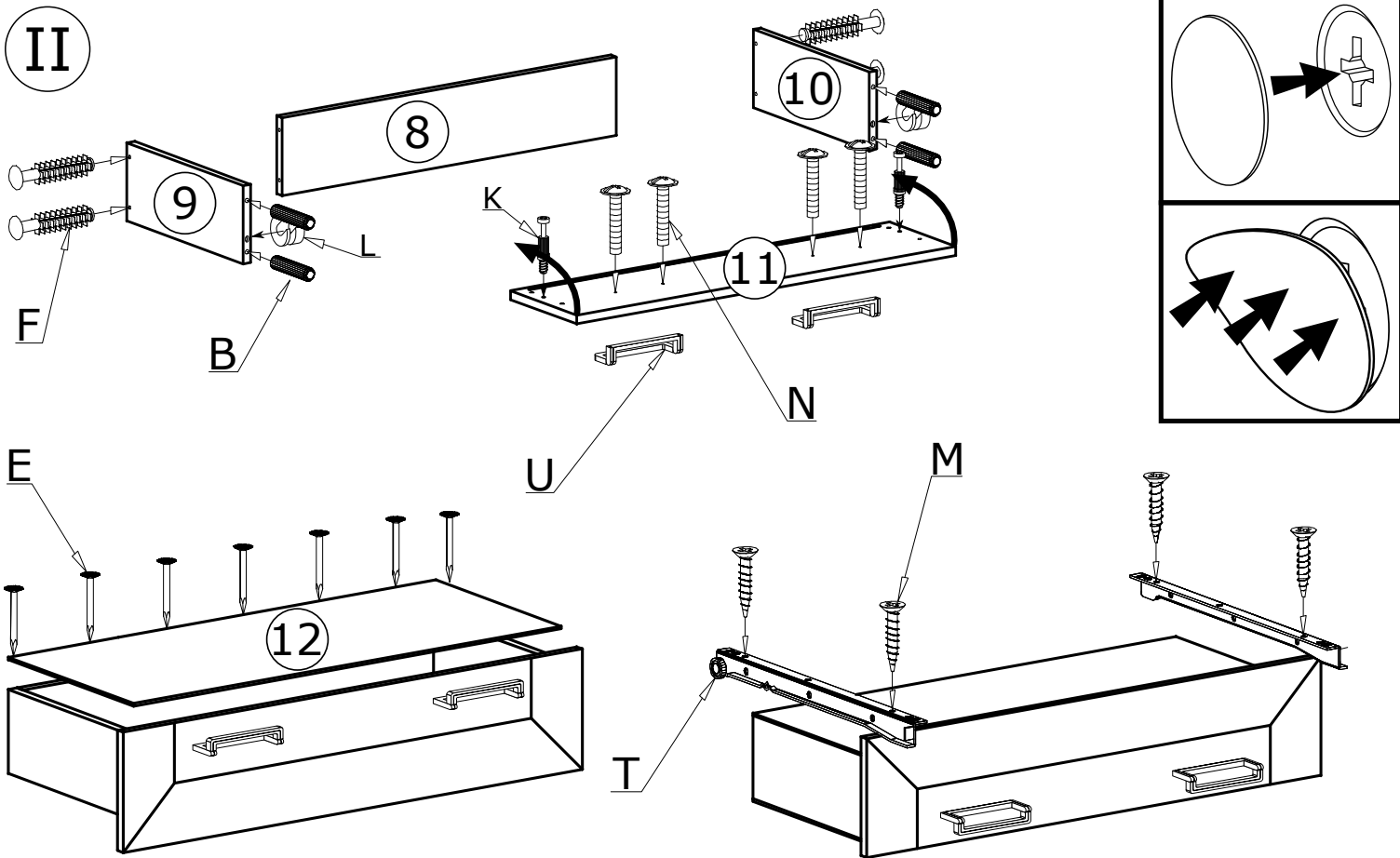

III

40X 

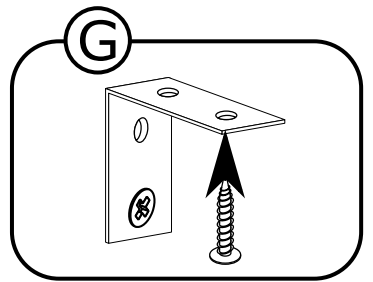
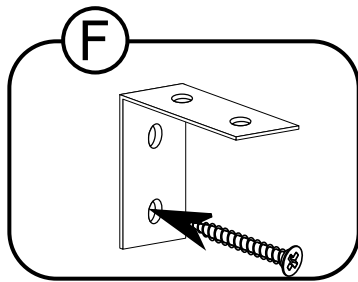
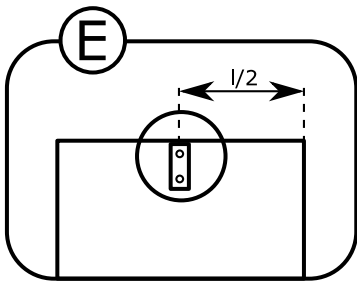
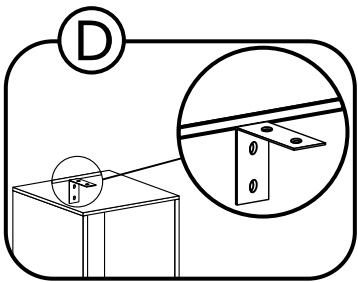
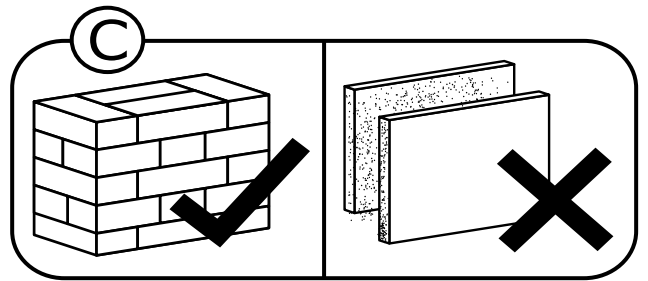
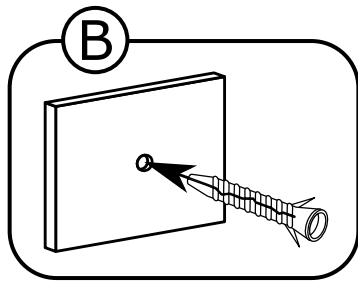
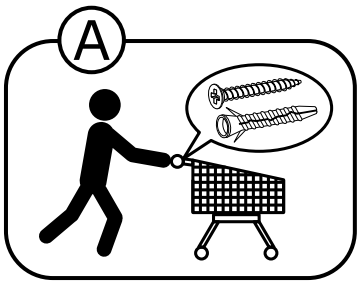
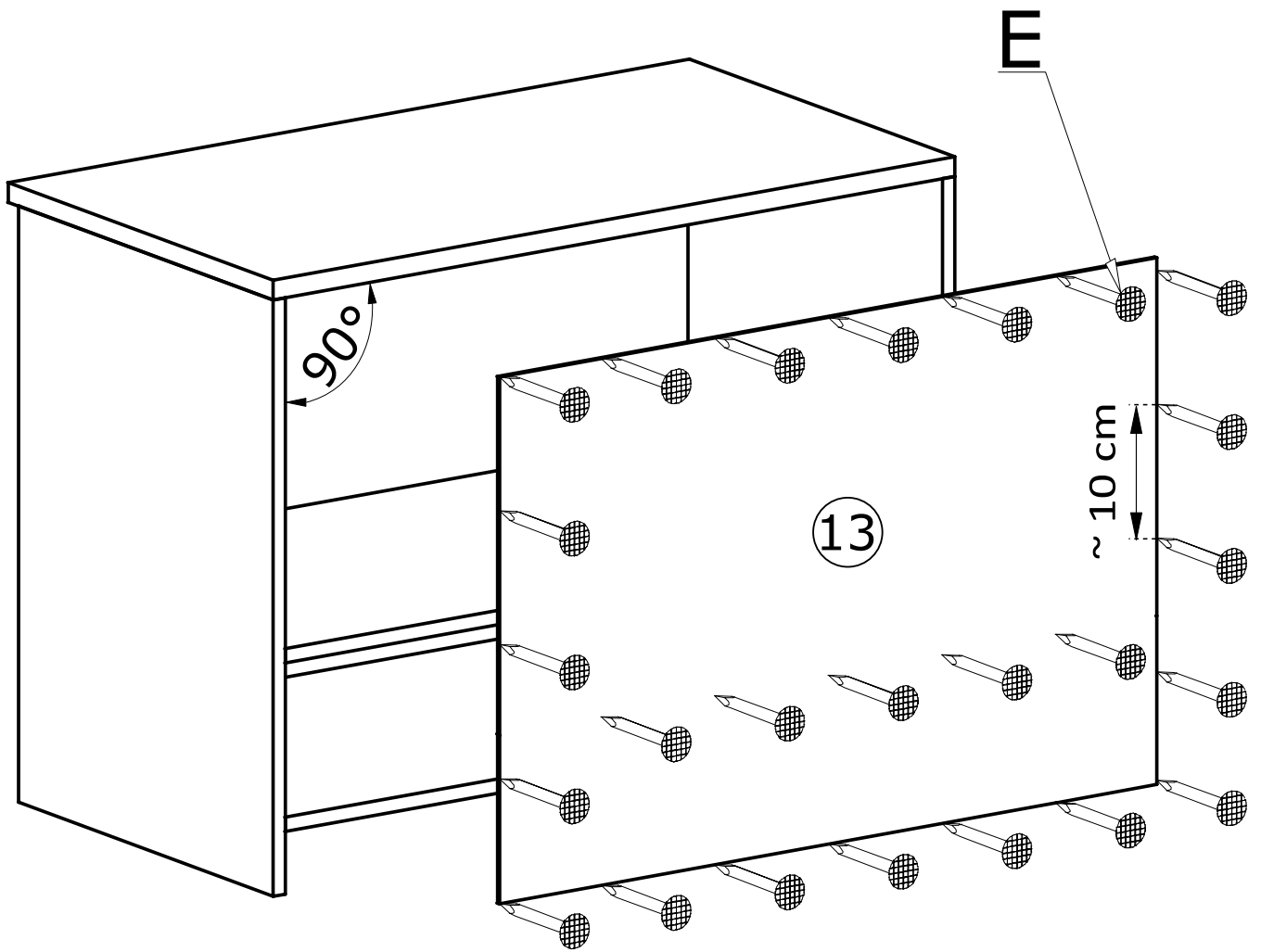

IV

