

TADEUSZ 14



Narzędzia potrzebne do montażu



UWAGA !!!

MONTOWANIE USZKODZONYCH
ELEMENTÓW POWODUJE UTRATĘ
GWARANCJI

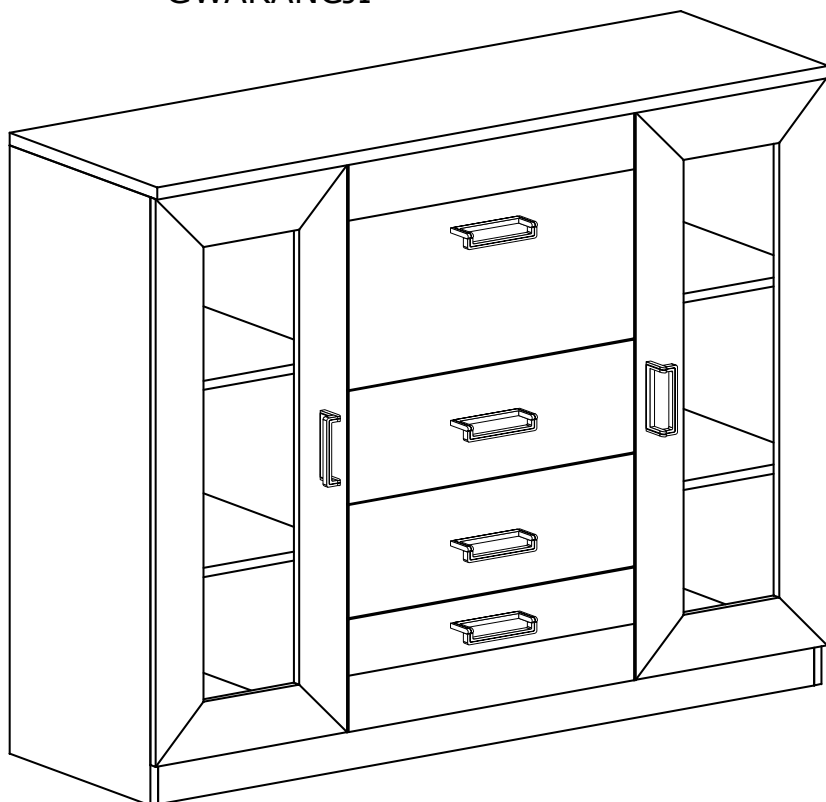

Nr	D[mm]	S[mm]	G[mm]	Ilość
1	1400	440	32	1
2	1352	405	16	1
3	965	405	16	1
4	965	405	16	1
5	1060	405	16	1
6	1060	405	16	1
7	480	405	16	1
8	423	150	16	3
9	400	150	16	3
10	400	150	16	3
11	490	190	16	3
12	453	405	2,5	3
13	1010	500	2,5	1
14	1010	440	2,5	2
15	1352	80	16	1
16	964	438	16	2
17	420	380	16	4
18	490	385	16	1

W przypadku reklamacji proszę podać numer pakowacza znajdujący się na kartonie.

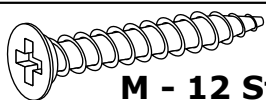

M - 12 St.
3x30 mm

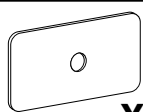

Y - 12 St.

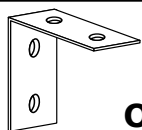

O - 1 St.

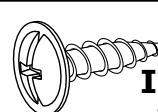

I - 2 St.
3,5x16 mm



X2 - 9 St.

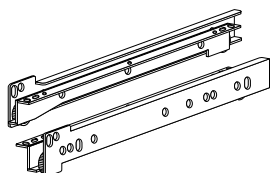

T - 3 Kpl.

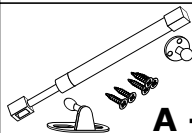

A - 1 St.



U - 6 St.

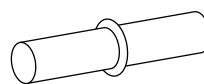

P - 16 St.



X1 - 18 St.

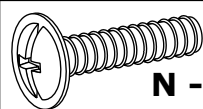

N - 8 St.
4x22 mm

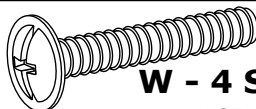

W - 4 St.
4x37 mm

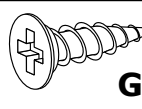

G - 24 St.
3,5x16 mm

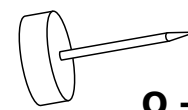

Q - 6 St.



F - 12 St.



E - 120 St.

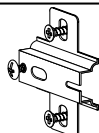

C - 6 St.

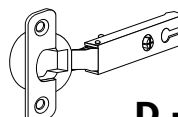

D - 6 St.



L - 18 St.



R - 9 St.

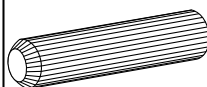

B - 32 St.

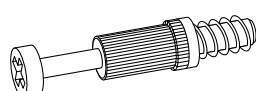

K - 18 St.



Z - 1 St.

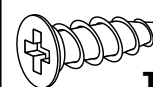

J - 12 St.
5x13 mm

I

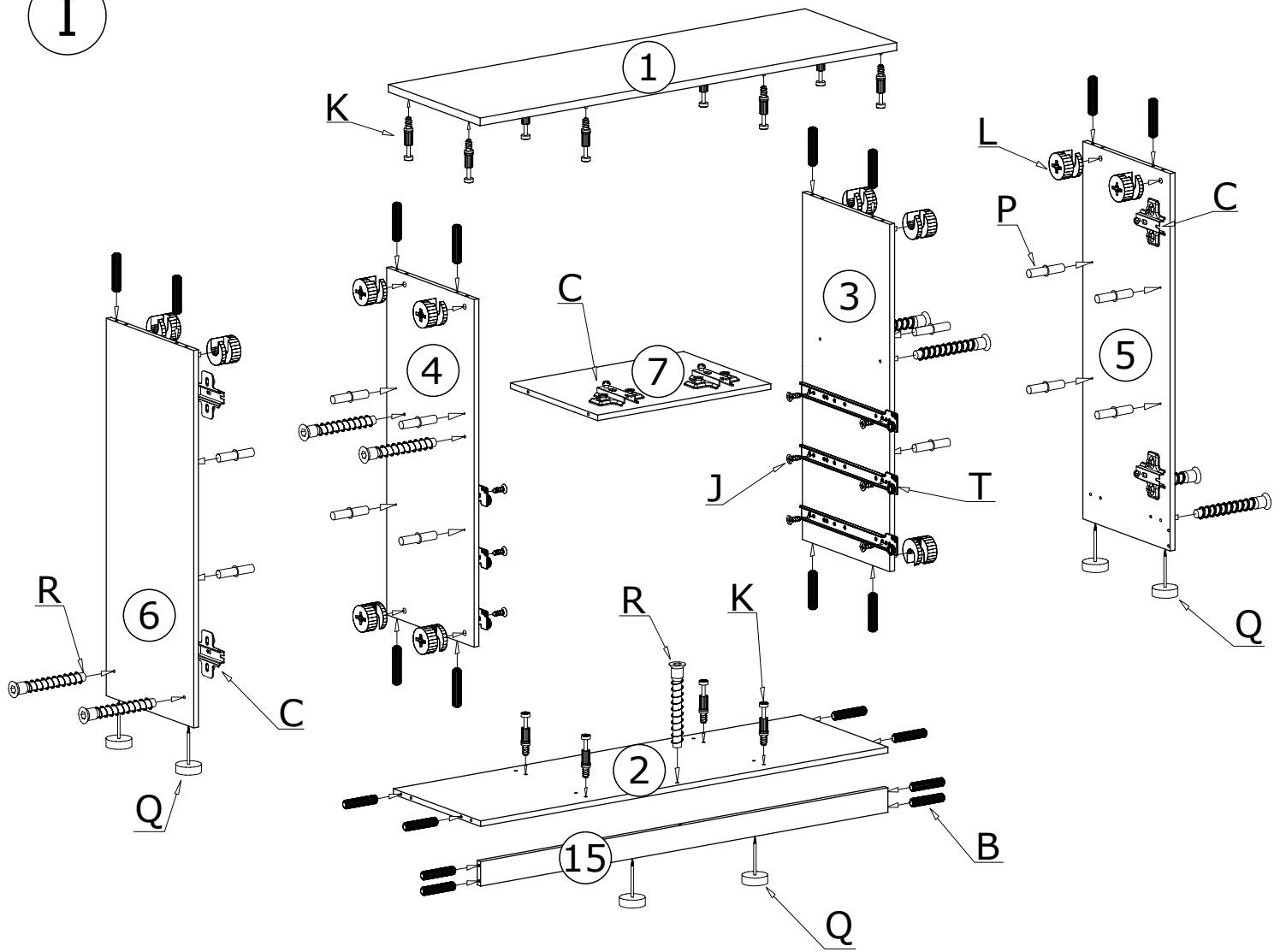

II

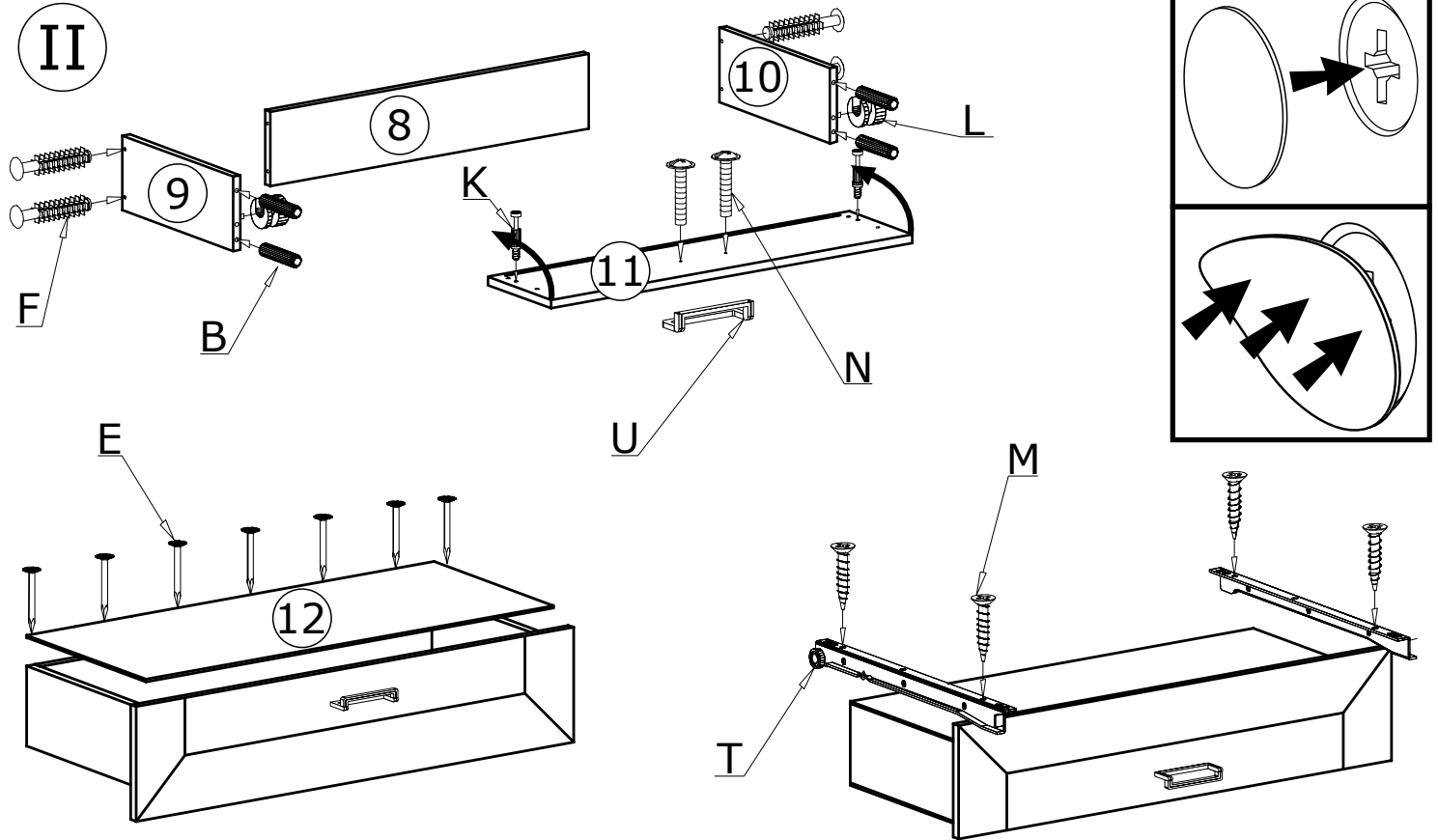

III

120X 

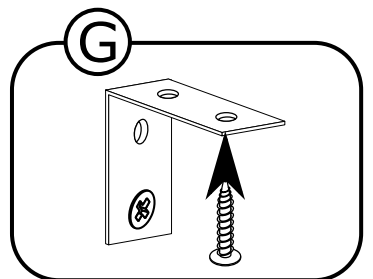
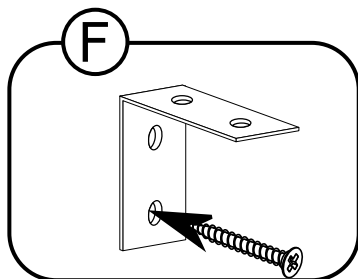
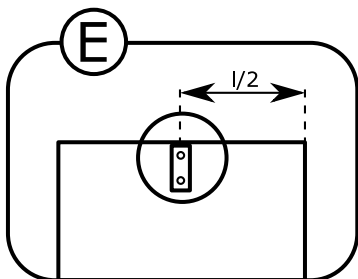
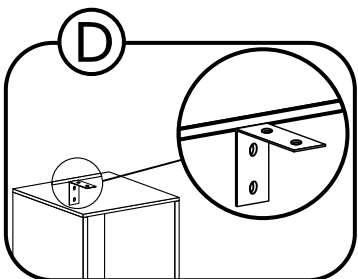
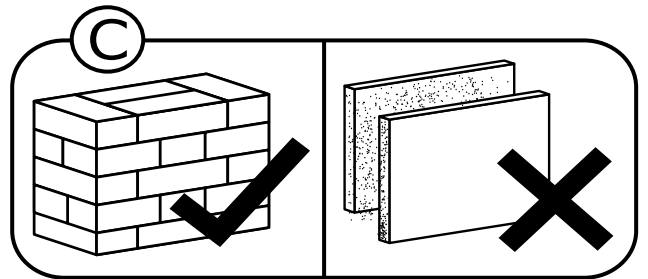
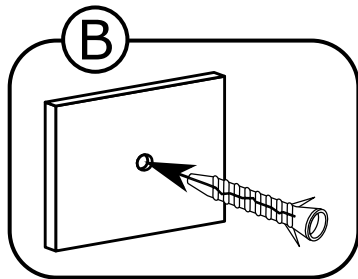
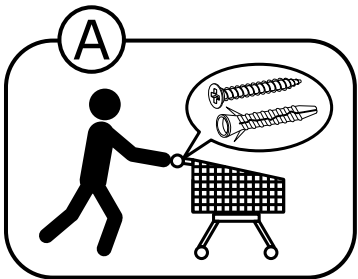
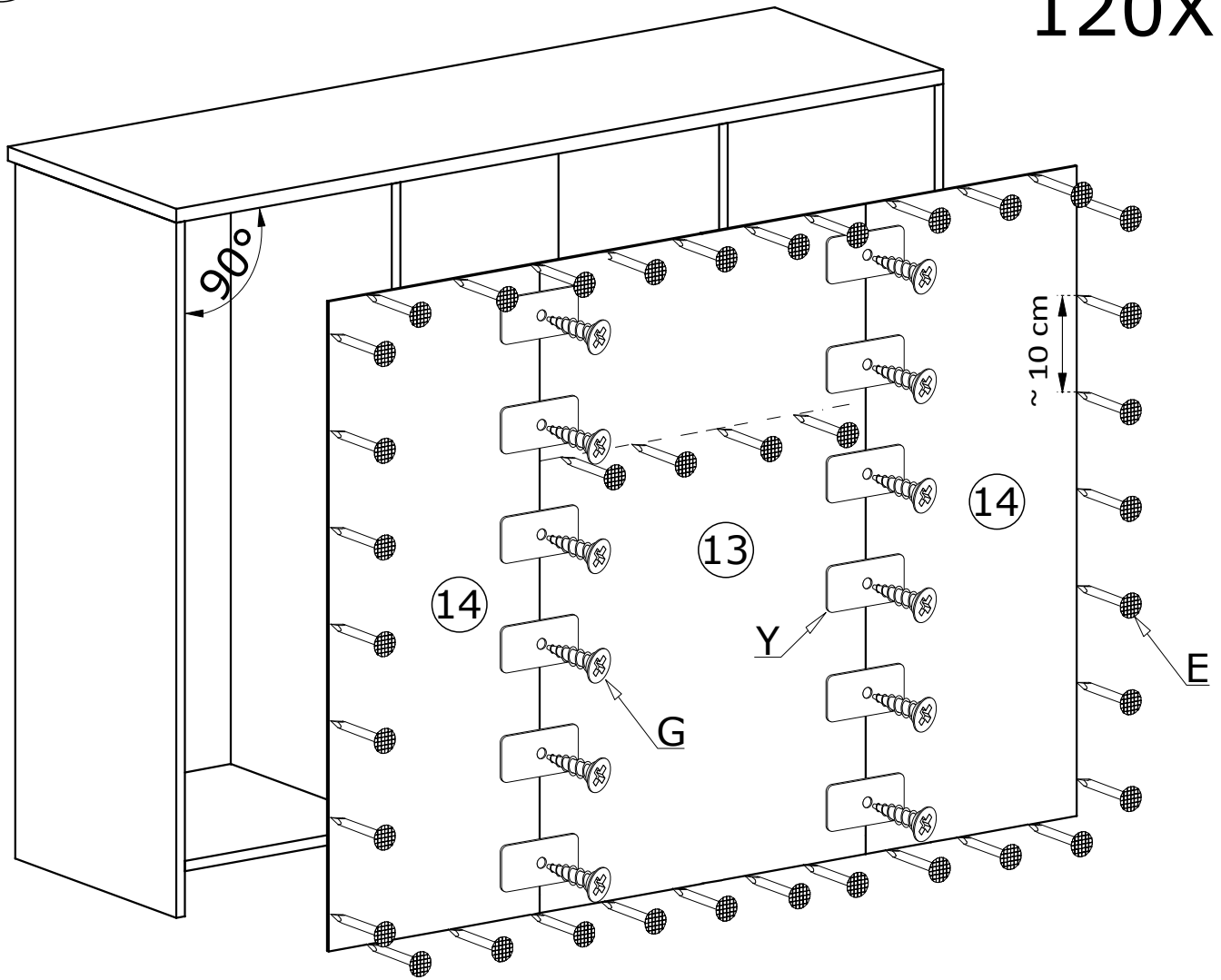

IV

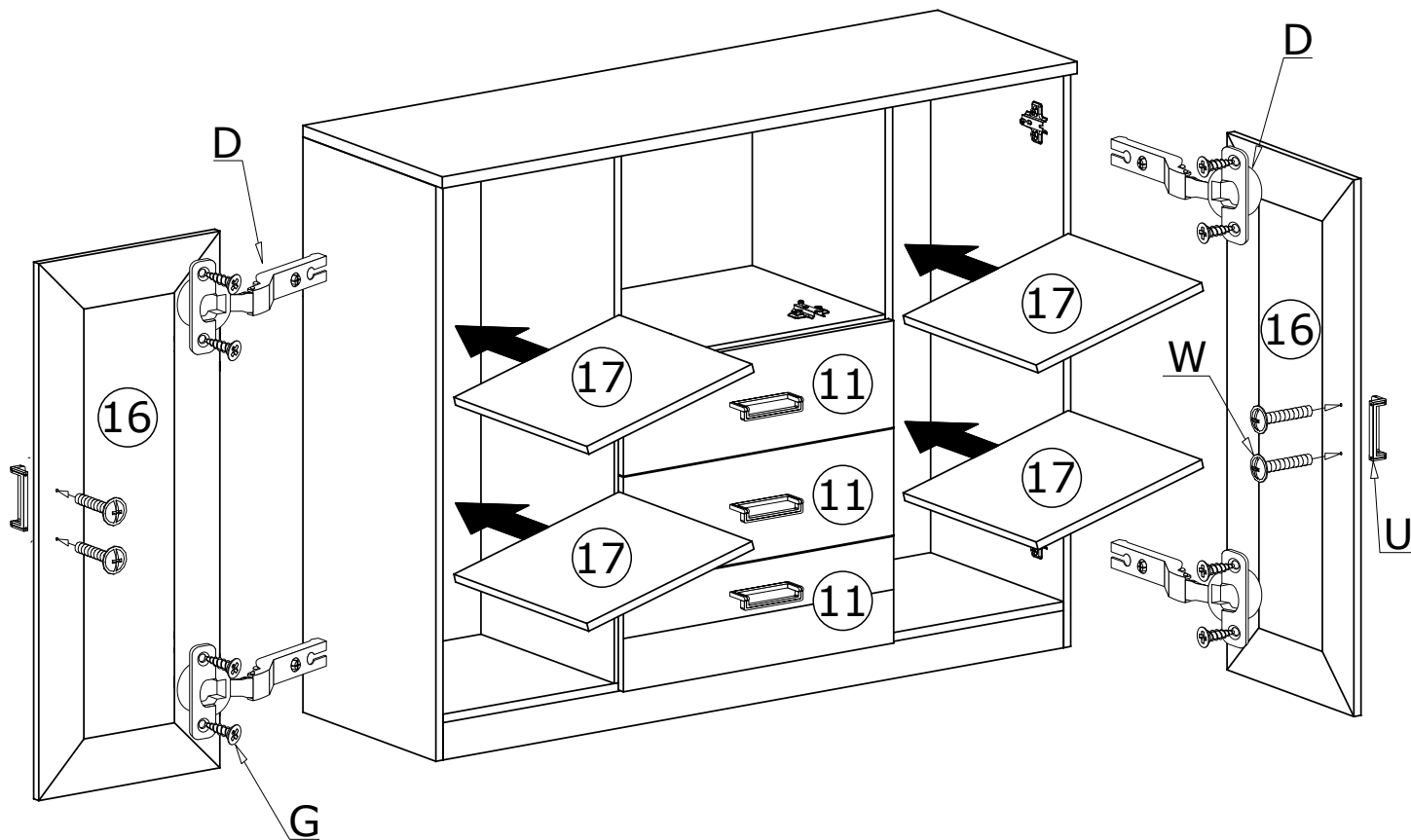

V

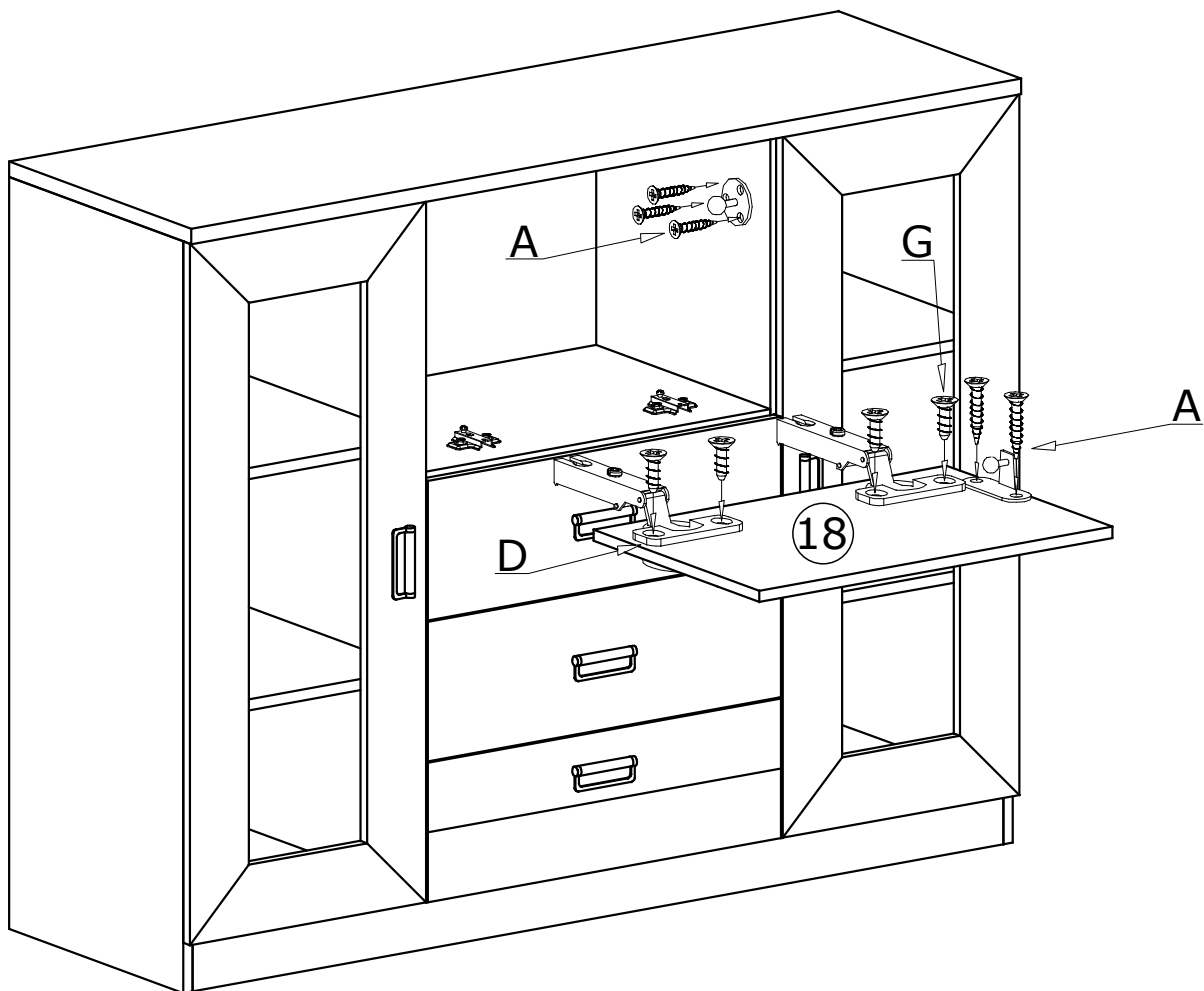

VI

