

TADEUSZ 9

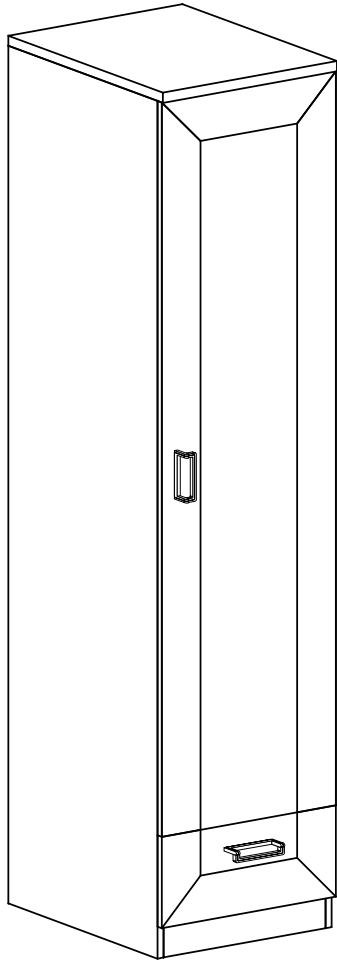

Narzędzia potrzebne do montażu

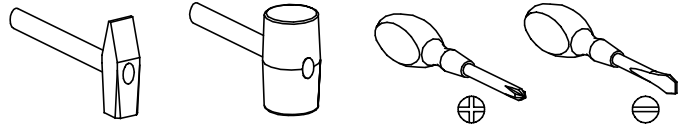

Nr	D[mm]	S[mm]	G[mm]	Ilość
1	575	460	32	1
2	540	412	16	1
3	540	412	16	1
4	412	80	16	1
5	540	412	16	3
6	1872	540	16	1
7	1872	540	16	1
8	1585	438	16	1
9	1800	437	2,5	1
10	440	190	16	1
11	500	150	16	1
12	500	150	16	1
13	355	150	16	1
14	505	384	2,5	1

UWAGA !!!

MONTOWANIE USZKODZONYCH
ELEMENTÓW POWODUJE UTRATĘ
GWARANCJI

W przypadku reklamacji proszę podać numer pakowacza znajdujący się na kartonie.



X3 - 6 St.

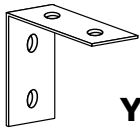

Y - 1 St.

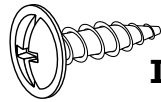

I - 2 St.
3,5x16 mm

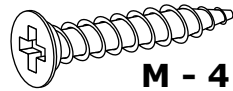

M - 4 St.
4x25 mm

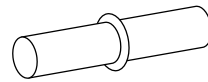

P - 12 St.



X2 - 8 St.

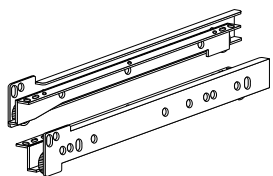

T - 1 Kpl.

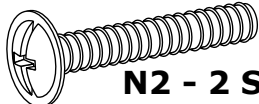

N2 - 2 St.
4x37 mm



R - 1 St.



Q - 4 St.



X1 - 8 St.

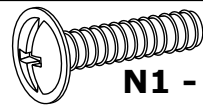

N1 - 1 St.
4x22 mm

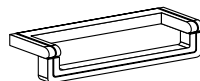

U - 2 St.

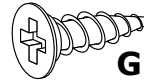

G - 10 St.
3,5x16 mm

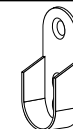

Y - 2 St.

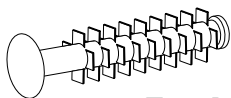

F - 4 St.



E - 60 St.

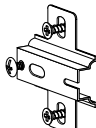

C - 3 St.

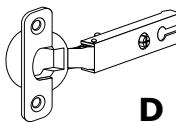

D - 3 St.

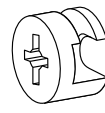

L - 8 St.

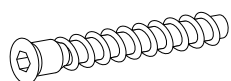

A - 8 St.

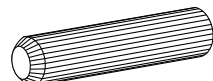

B - 20 St.

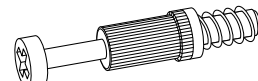

K - 8 St.

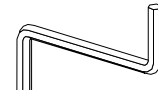

Z - 1 St.

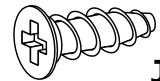

J - 4 St.
5x13 mm

I

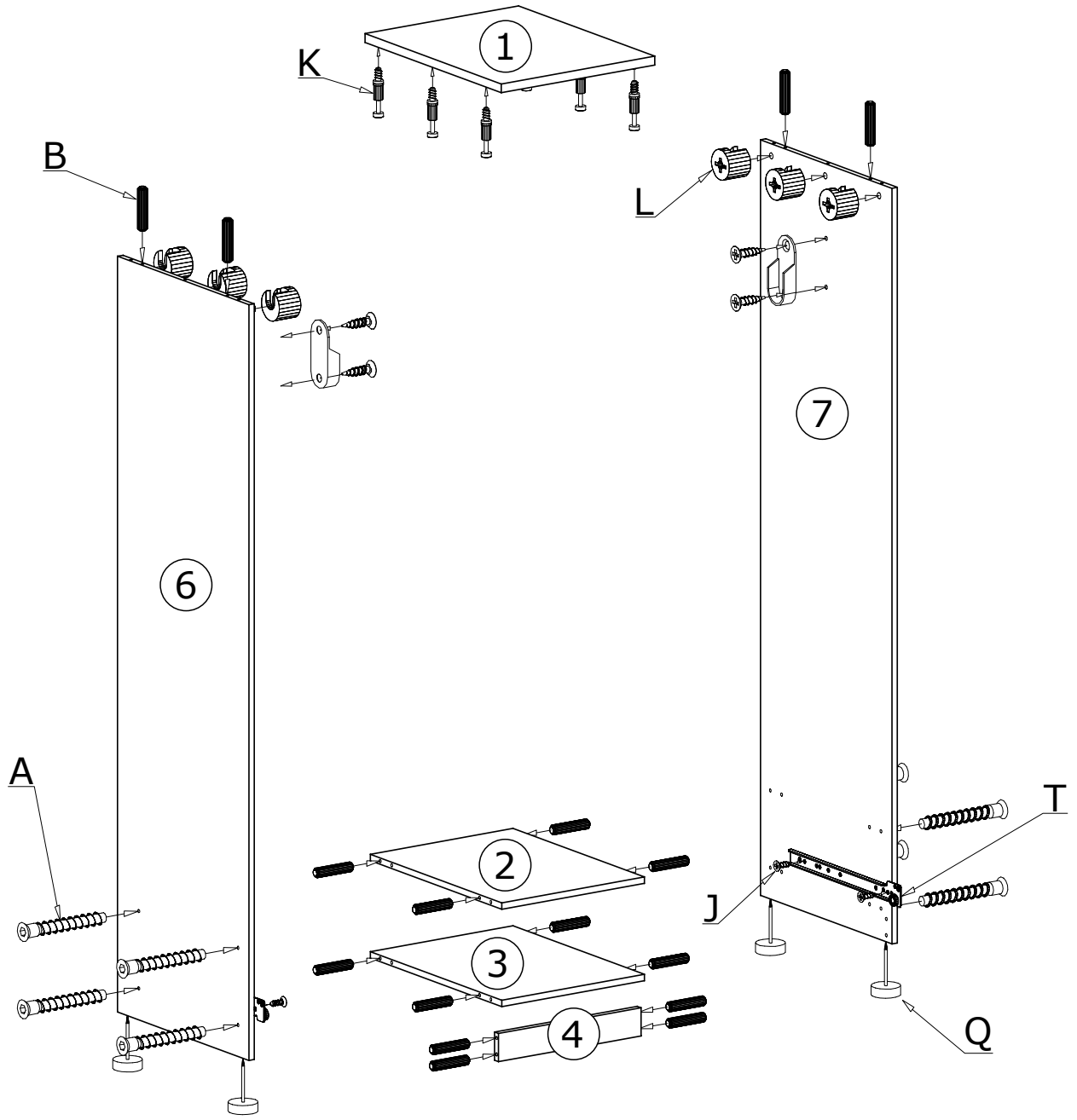

II

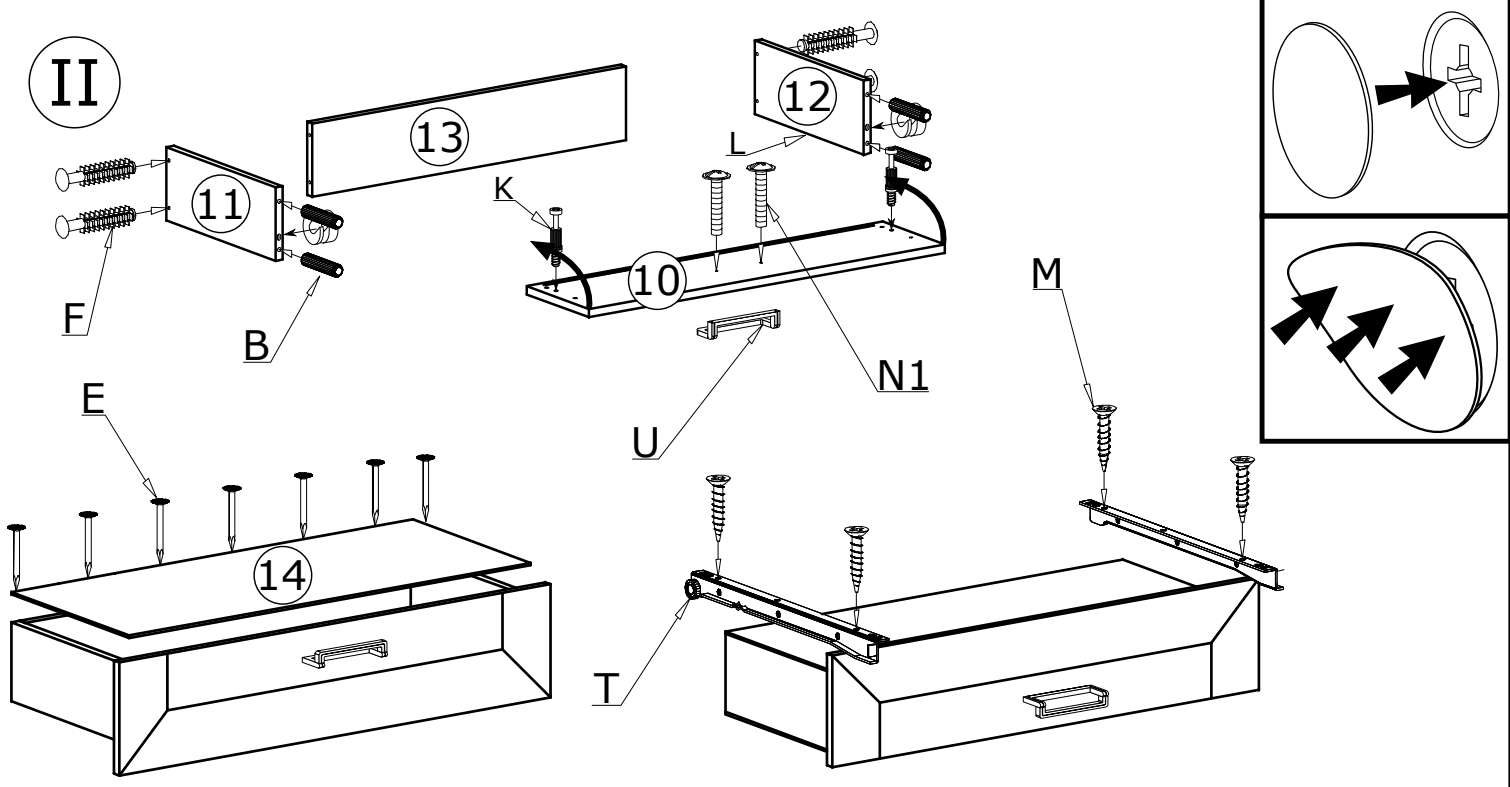

III

60X 

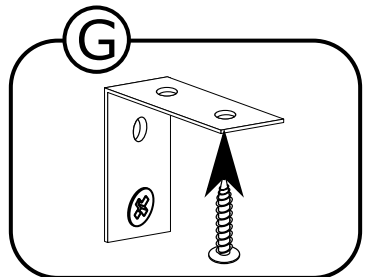
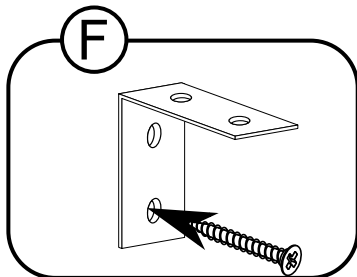
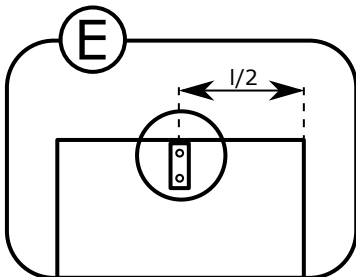
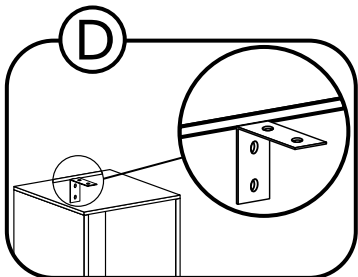
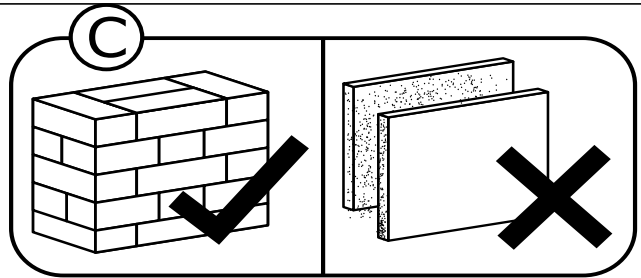
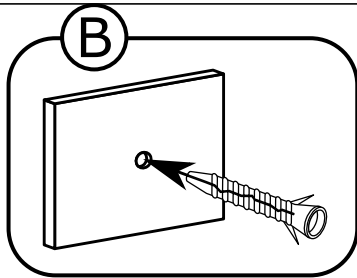
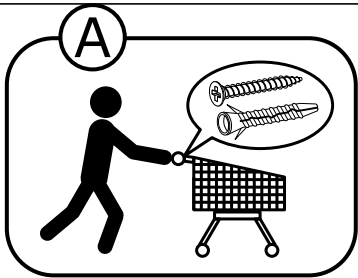
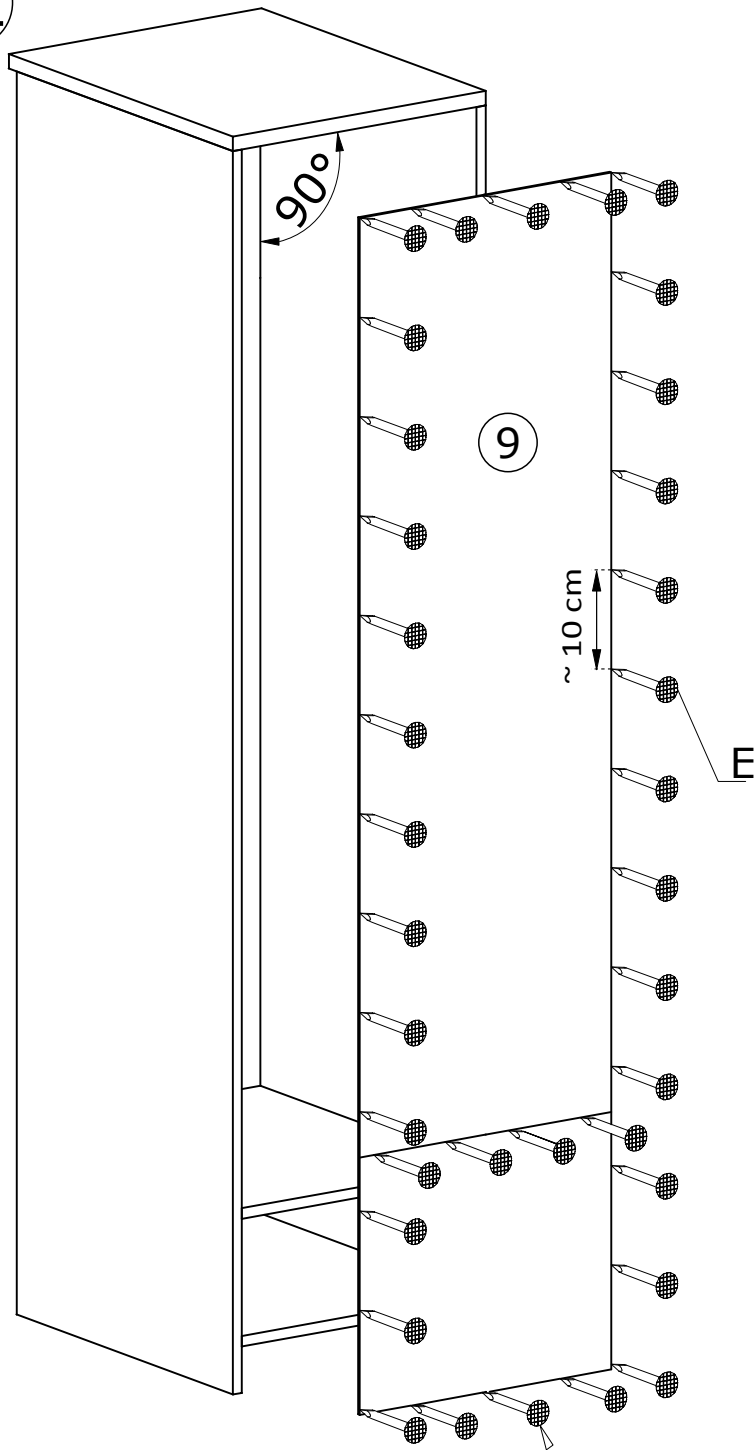

IV

