

TADEUSZ 3



Narzędzia potrzebne do montażu



UWAGA !!!

MONTOWANIE USZKODZONYCH
ELEMENTÓW POWODUJE UTRATĘ
GWARANCJI

Nr	D[mm]	S[mm]	G[mm]	Ilość
1	1000	440	32	1
2	950	405	16	1
3	950	405	16	1
4	952	80	16	1
5	865	405	16	1
6	865	405	16	1
7	775	488	16	1
8	775	488	16	1
9	978	806	2,5	1

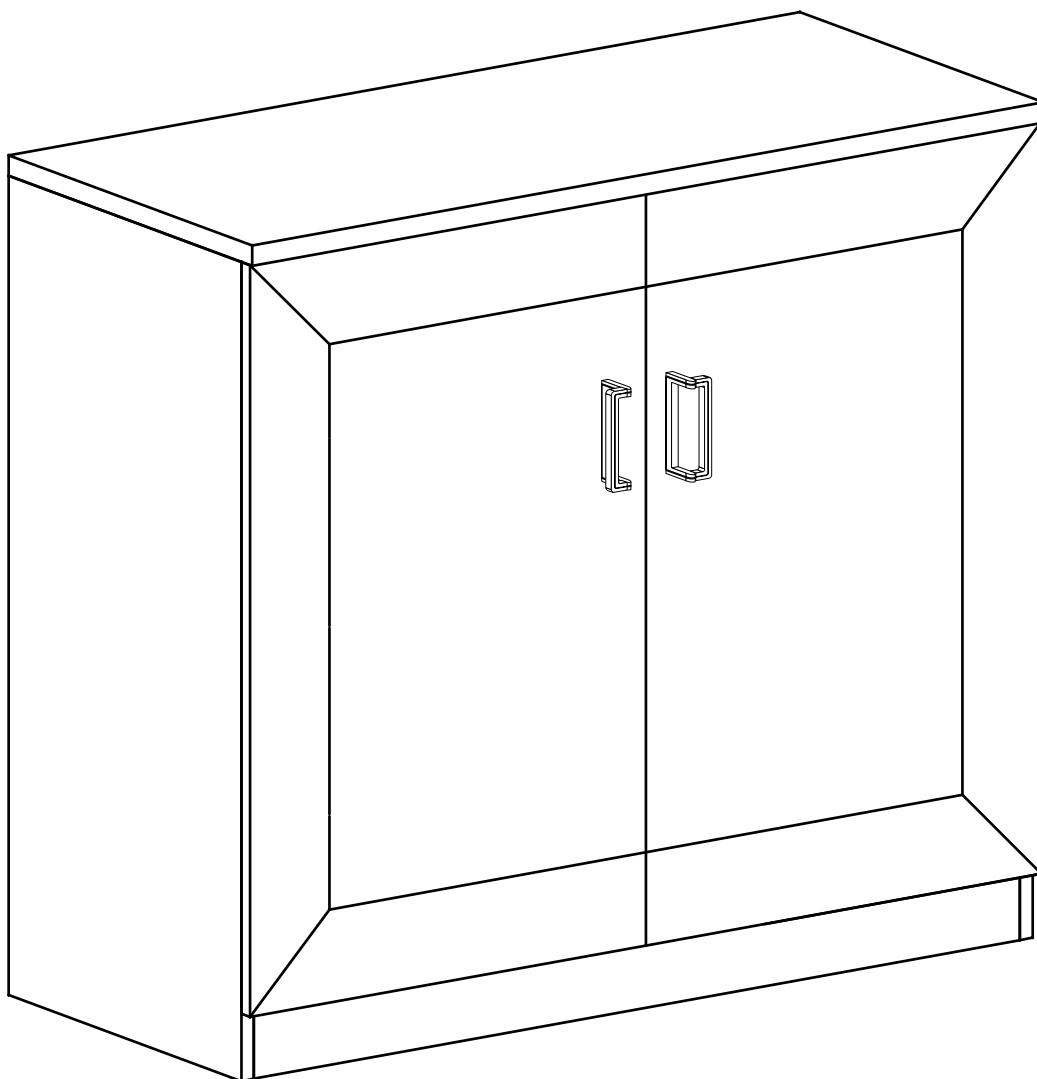

X1 - 4 St.



X2 - 8 St.

W przypadku reklamacji proszę podać numer pakowacza znajdujący się na kartonie.

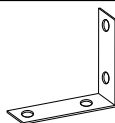

Y - 1 St.

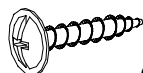

Q - 2 St.
3,5x16 mm



U - 2 St.



G - 8 St.
3,5x16 mm



L - 4 St.

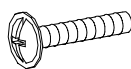

N - 4 St.
4x25 mm



E - 30 St.

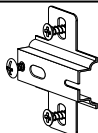

C - 4 St.

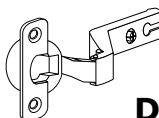

D - 4 St.



S - 1 St.

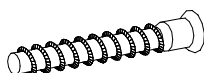

R - 9 St.



B - 12 St.

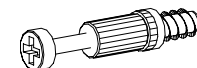

K - 4 St.

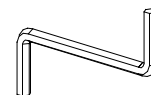

Z - 1 St.

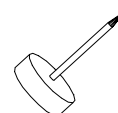

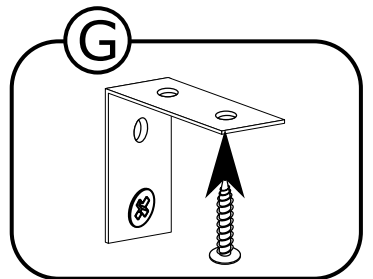
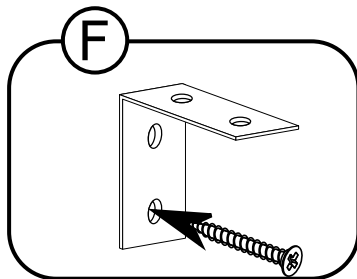
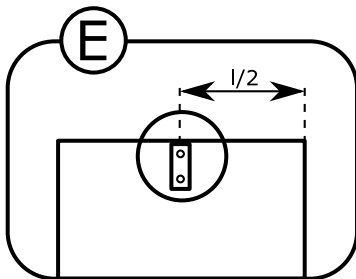
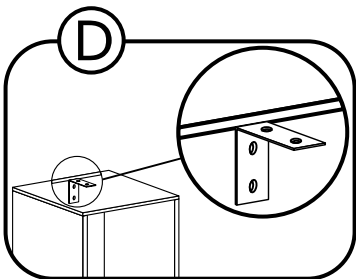
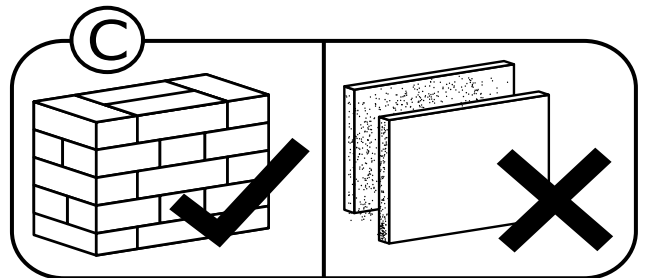
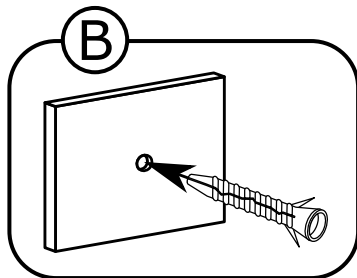
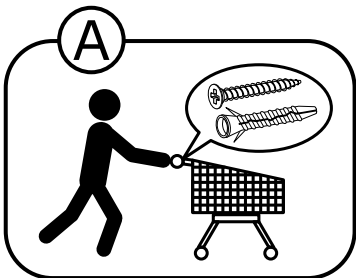
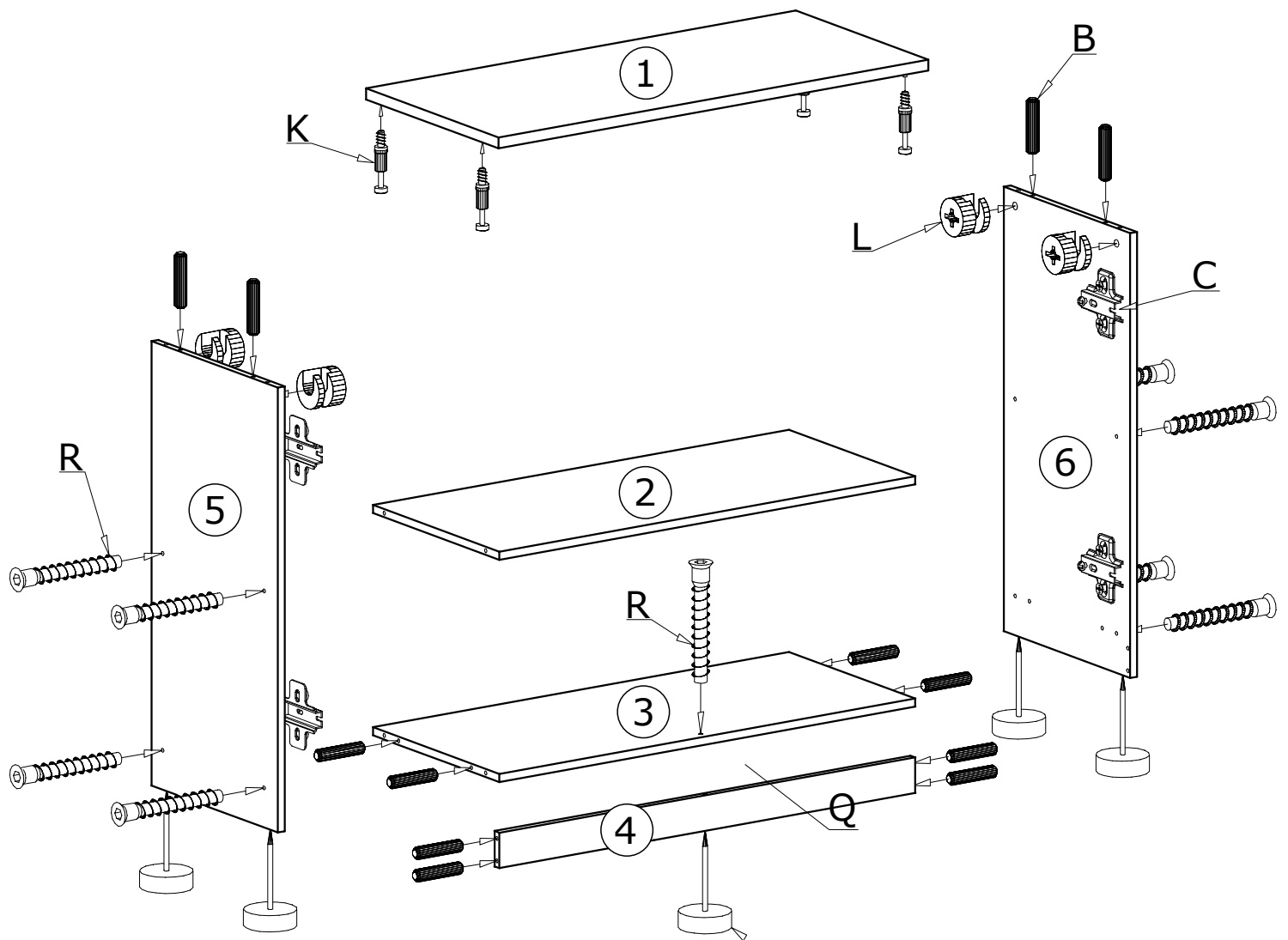

Q - 5 St.

I

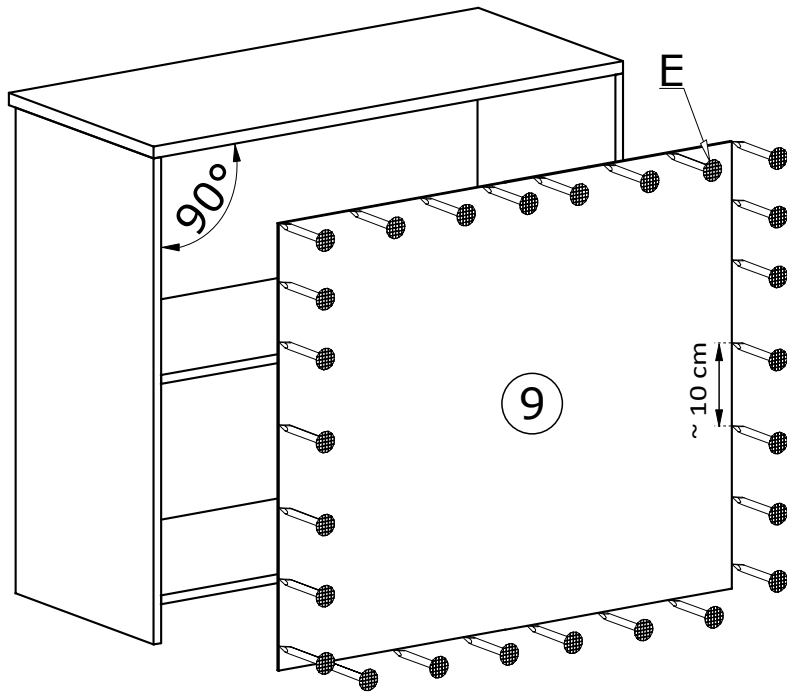

II



30X 

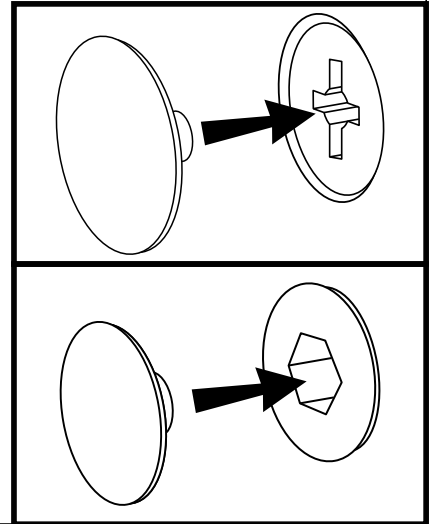

III

