

TADEUSZ 1

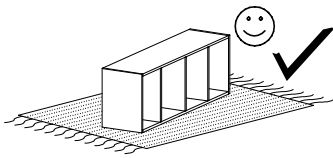

Narzędzia potrzebne do montażu

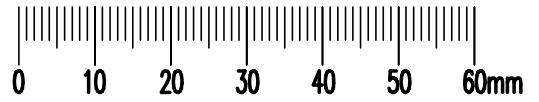
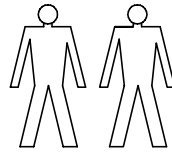
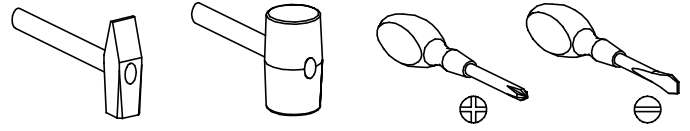

UWAGA !!!

MONTOWANIE USZKODZONYCH
ELEMENTÓW POWODUJE UTRATĘ
GWARANCJI

Nr	D[mm]	S[mm]	G[mm]	Ilość
1	900	440	32	1
2	852	406	16	1
3	865	405	16	1
4	865	405	16	1
5	852	80	16	1
6	877	806	2,5	1
7	793	150	16	4
8	400	150	16	4
9	400	150	16	4
10	880	190	16	4
11	823	405	2,5	4

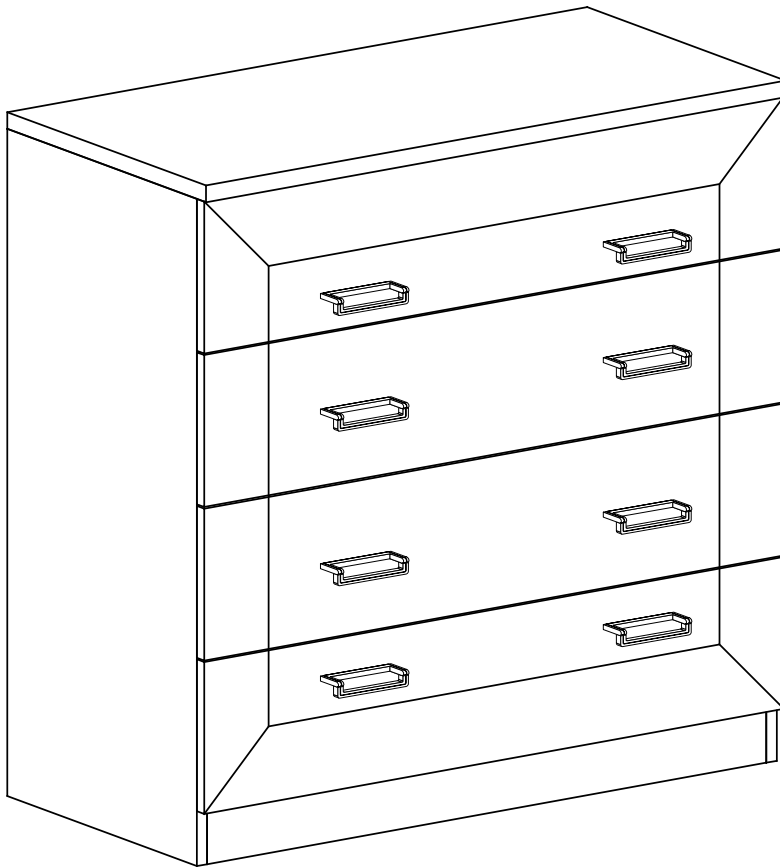

W przypadku reklamacji proszę podać numer pakowacza znajdujący się na kartonie.

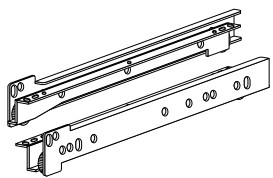

T - 4 Kpl.

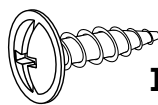

I - 2 St.
3,5x16 mm



X1 - 12 St.



X2 - 5 St.

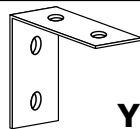

Y - 1 St.

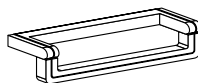

U - 8 St.

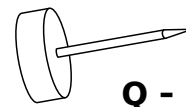

Q - 5 St.

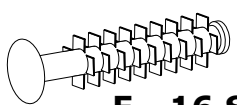

F - 16 St.



E - 80 St.

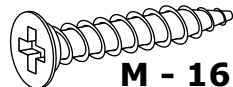

M - 16 St.
4x25 mm

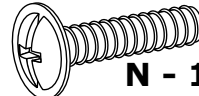

N - 16 St.
4x22 mm



L - 12 St.



R - 5 St.

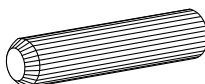

B - 28 St.

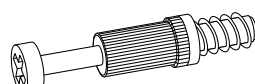

K - 12 St.

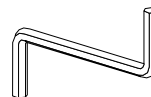

Z - 1 St.



J - 16 St.
5x13 mm

I

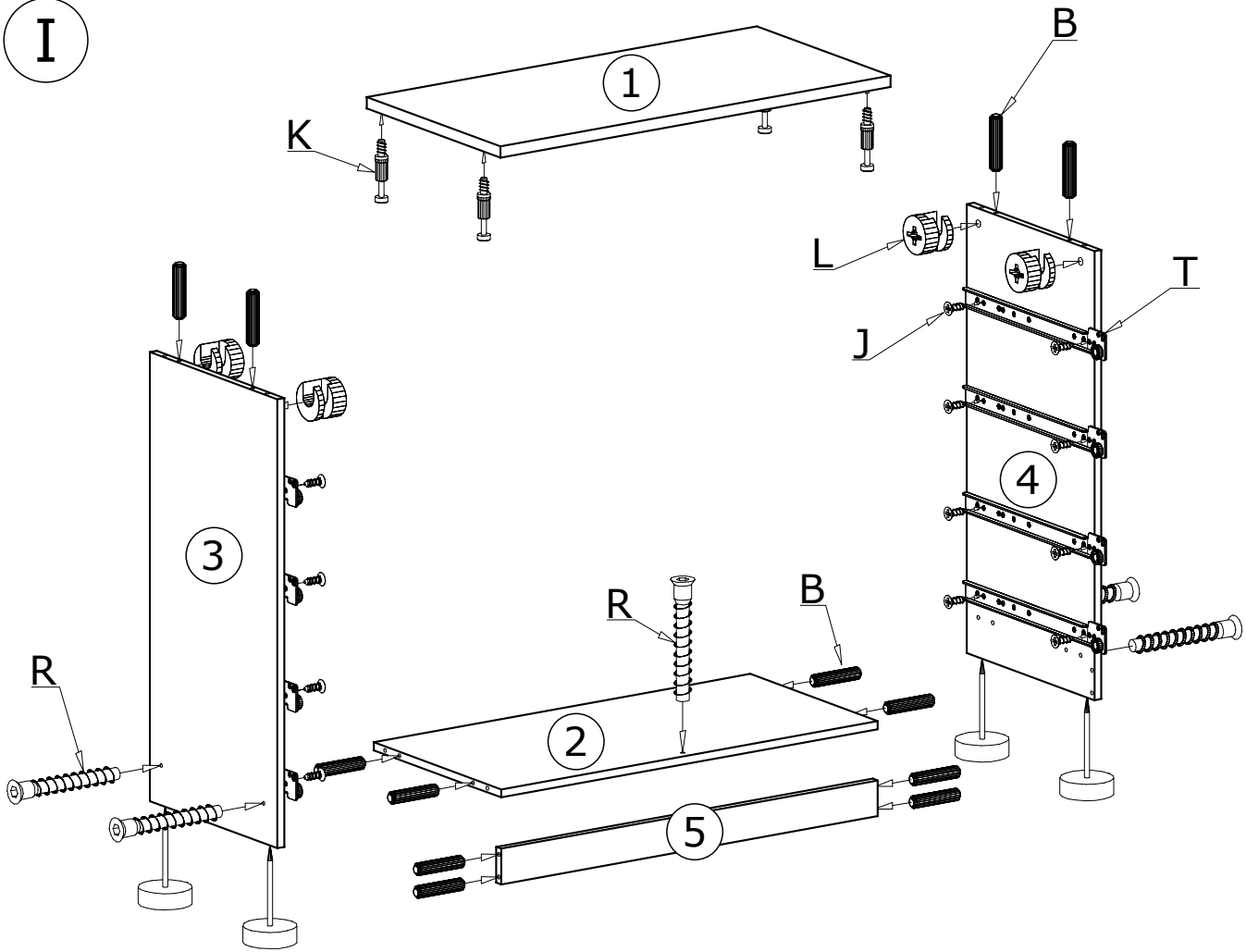

II

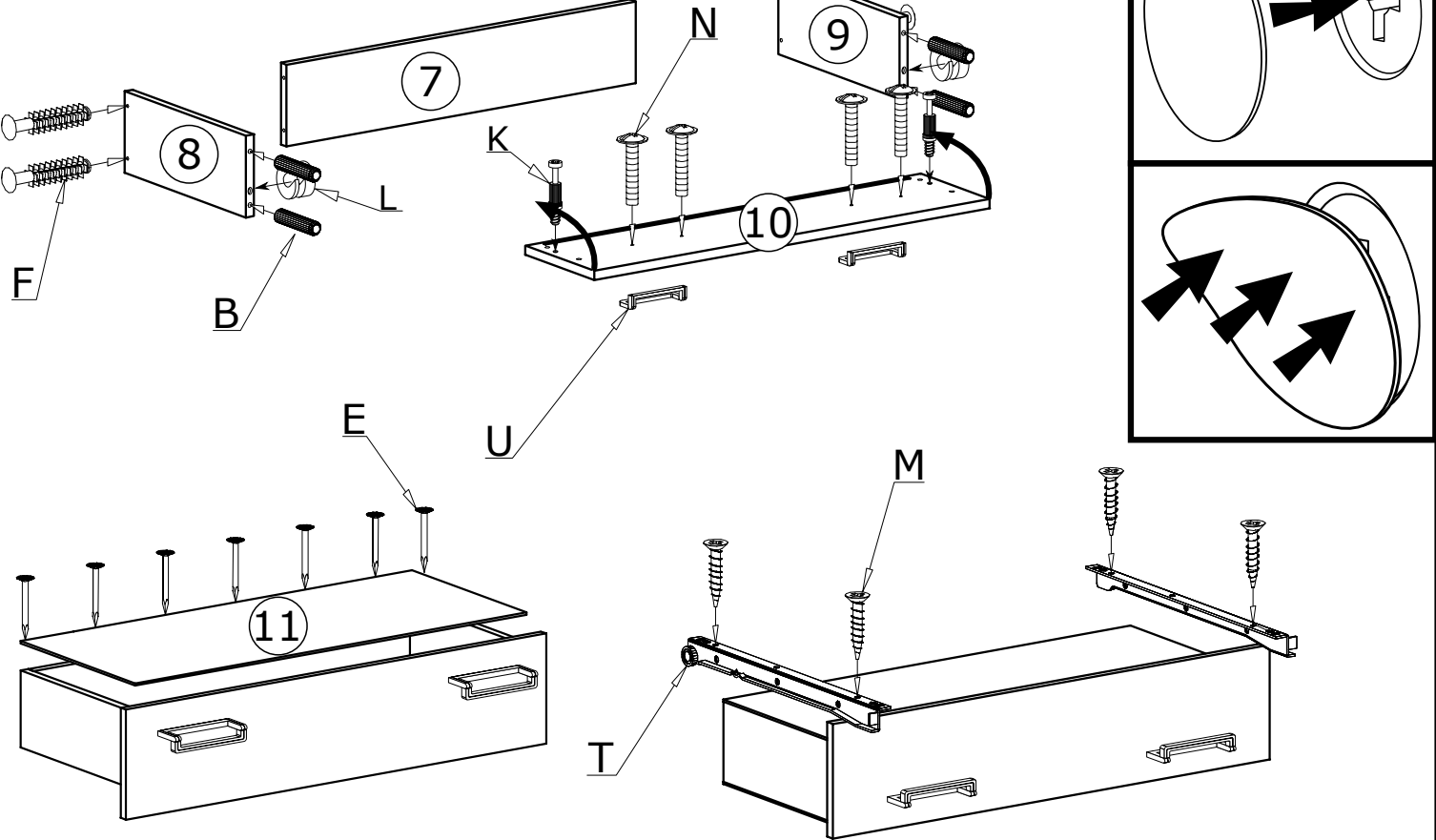

III

80X 

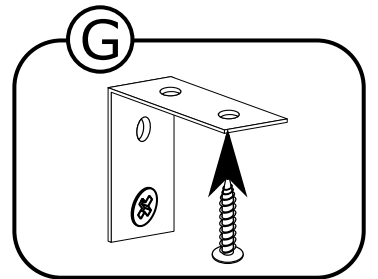
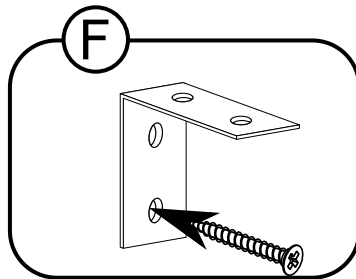
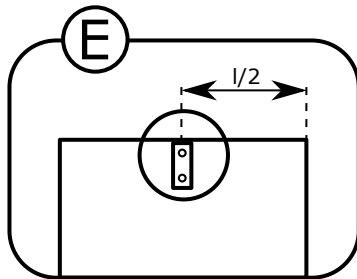
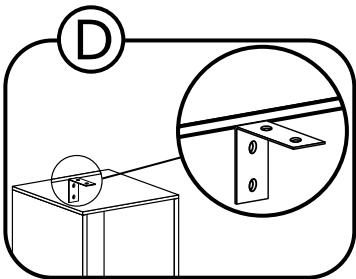
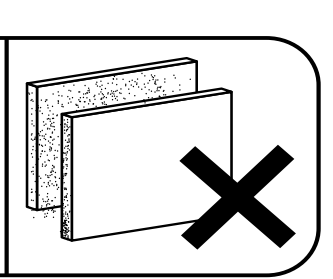
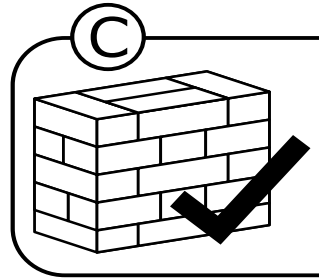
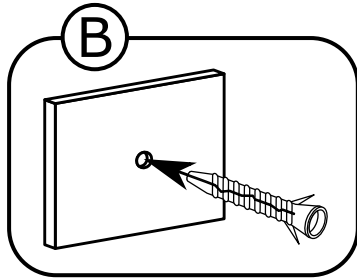
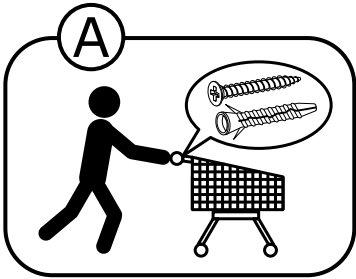
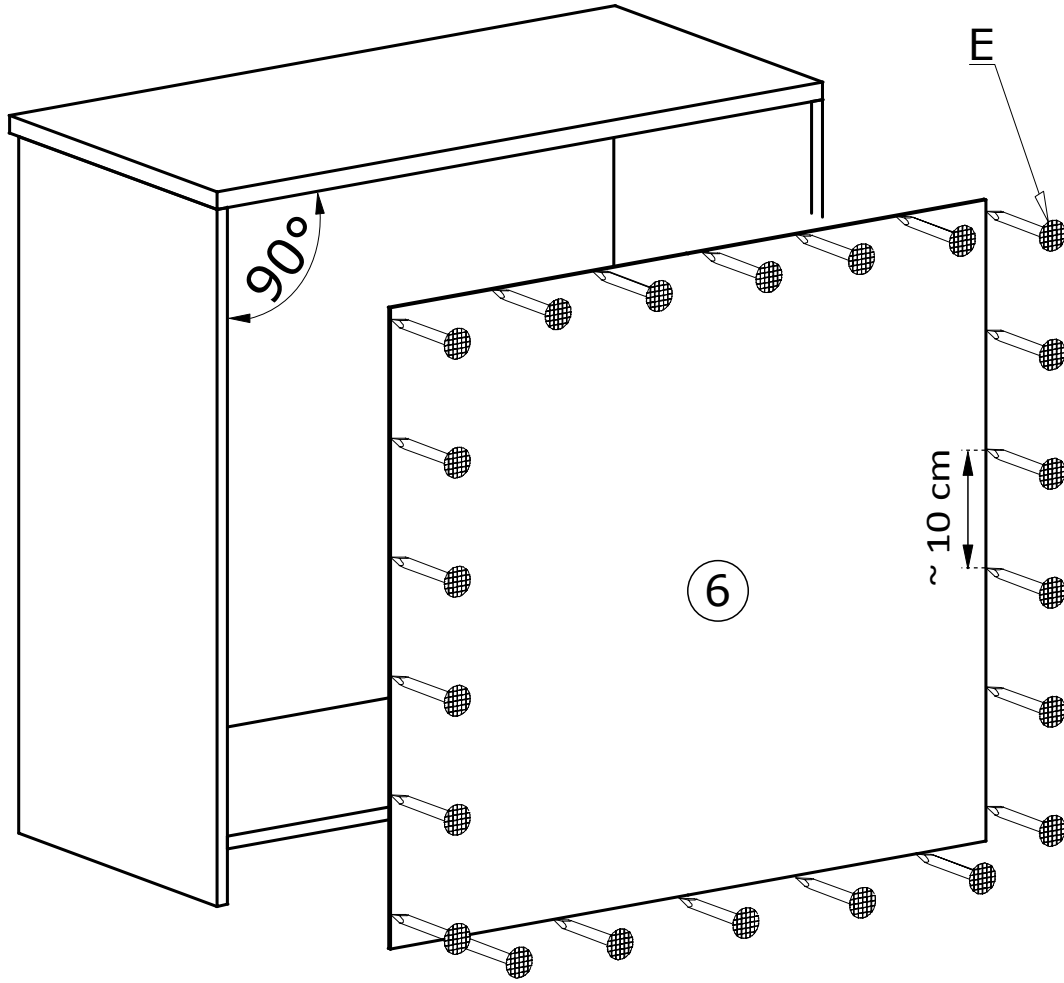

IV

