

# PARIS 13

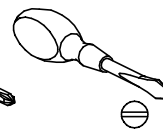

Narzędzia potrzebne do montażu

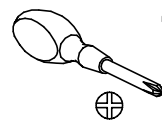
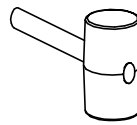
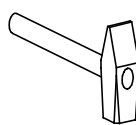

## **UWAGA !!!**

MONTOWANIE USZKODZONYCH  
ELEMENTÓW POWODUJE UTRATĘ  
GWARANCJI

Nr	D[mm]	S[mm]	G[mm]	Ilość
1	800	320	16	1
2	800	160	48	1

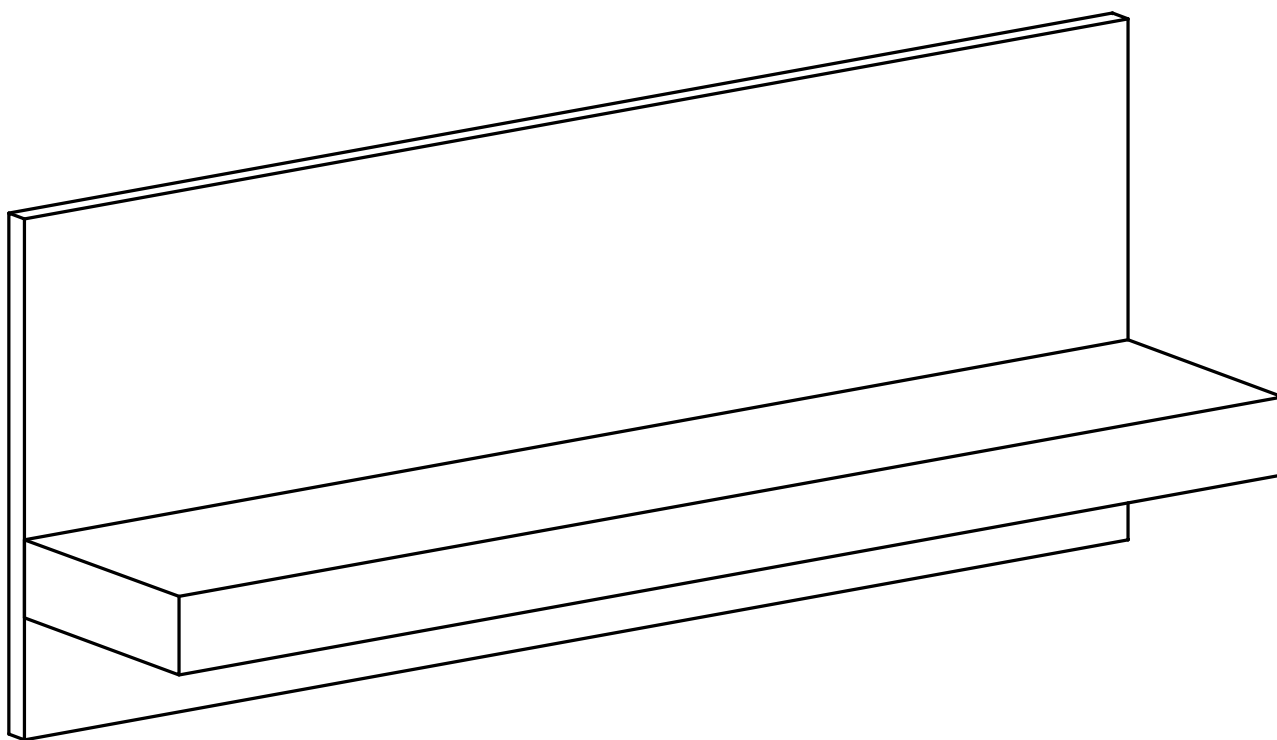

W przypadku reklamacji proszę podać numer pakowacza znajdujący się na kartonie.

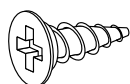

**G - 4 St.**  
3,5x13 mm



**Z - 1 St.**



**S - 2 St.**

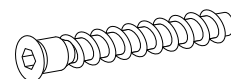

**A - 3 St.**

I

