

PARIS 9

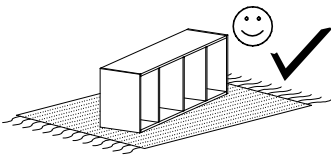

Narzędzia potrzebne do montażu

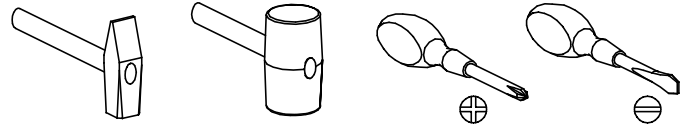

UWAGA !!!

MONTOWANIE USZKODZONYCH
ELEMENTÓW POWODUJE UTRATĘ
GWARANCJI

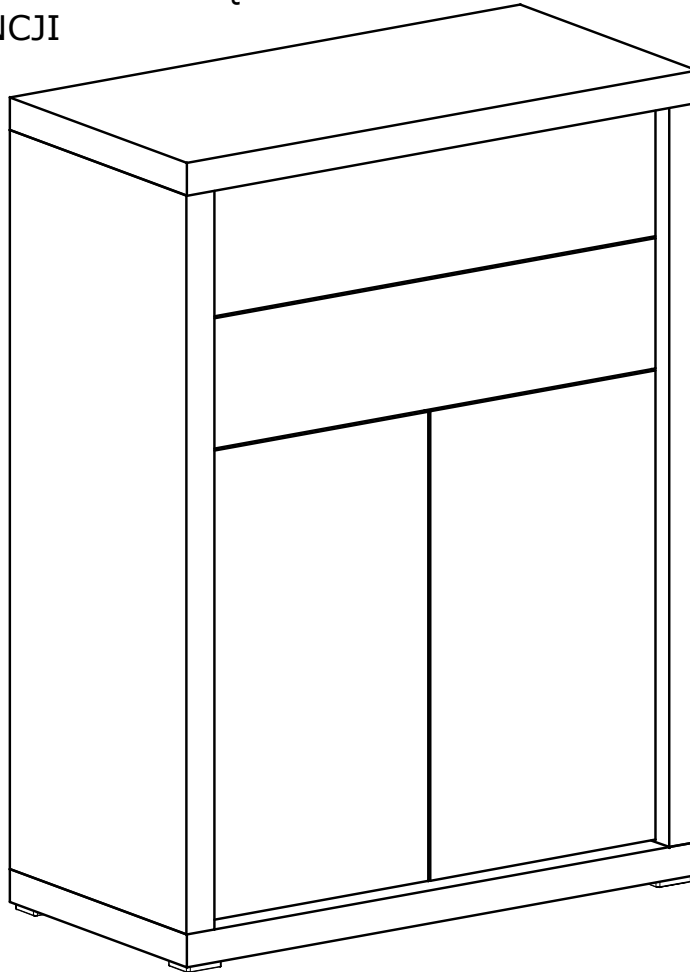

Nr	D[mm]	S[mm]	G[mm]	Ilość
1	882	436	48	1
2	882	436	48	1
3	1098	435	48	1
4	1098	435	48	1
5	848	388	16	1
6	780	190	16	2
7	350	165	16	2
8	350	165	16	2
9	726	165	16	2
10	756	355	2,5	2
11	870	392	2,5	1
12	700	388	16	1
13	700	388	16	1
14	870	754	2,5	1

W przypadku reklamacji proszę podać numer pakowacza znajdujący się na kartonie.

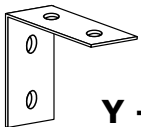

Y - 1 St.

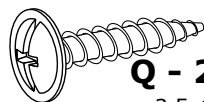

Q - 2 St.
3,5x16 mm

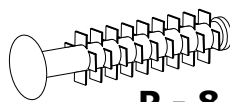

P - 8 St.

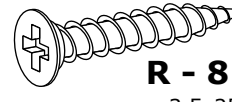

R - 8 St.
3,5x25 mm



X1 - 16 St.

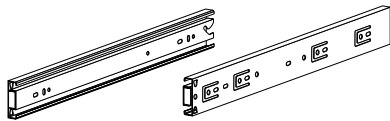

T - 2 Kpl.

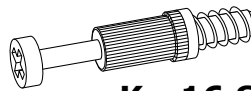

K - 16 St.

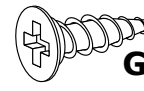

G - 20 St.
3,5x16 mm

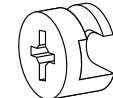

L - 16 St.

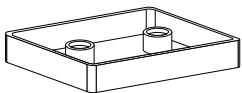

A - 4 St.

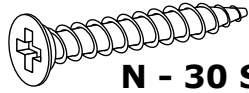

N - 30 St.
3x30 mm

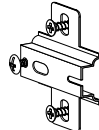

C - 4 St.

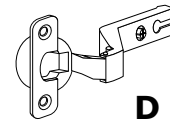

D - 4 St.

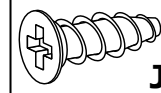

J - 16 St.
5x13 mm

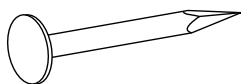

E - 60 St.

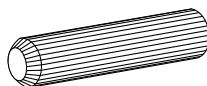

B - 20 St.

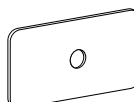

S - 8 St.

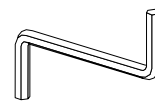

Z - 1 St.

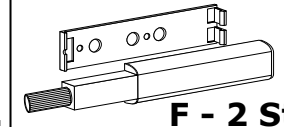

F - 2 St.

I

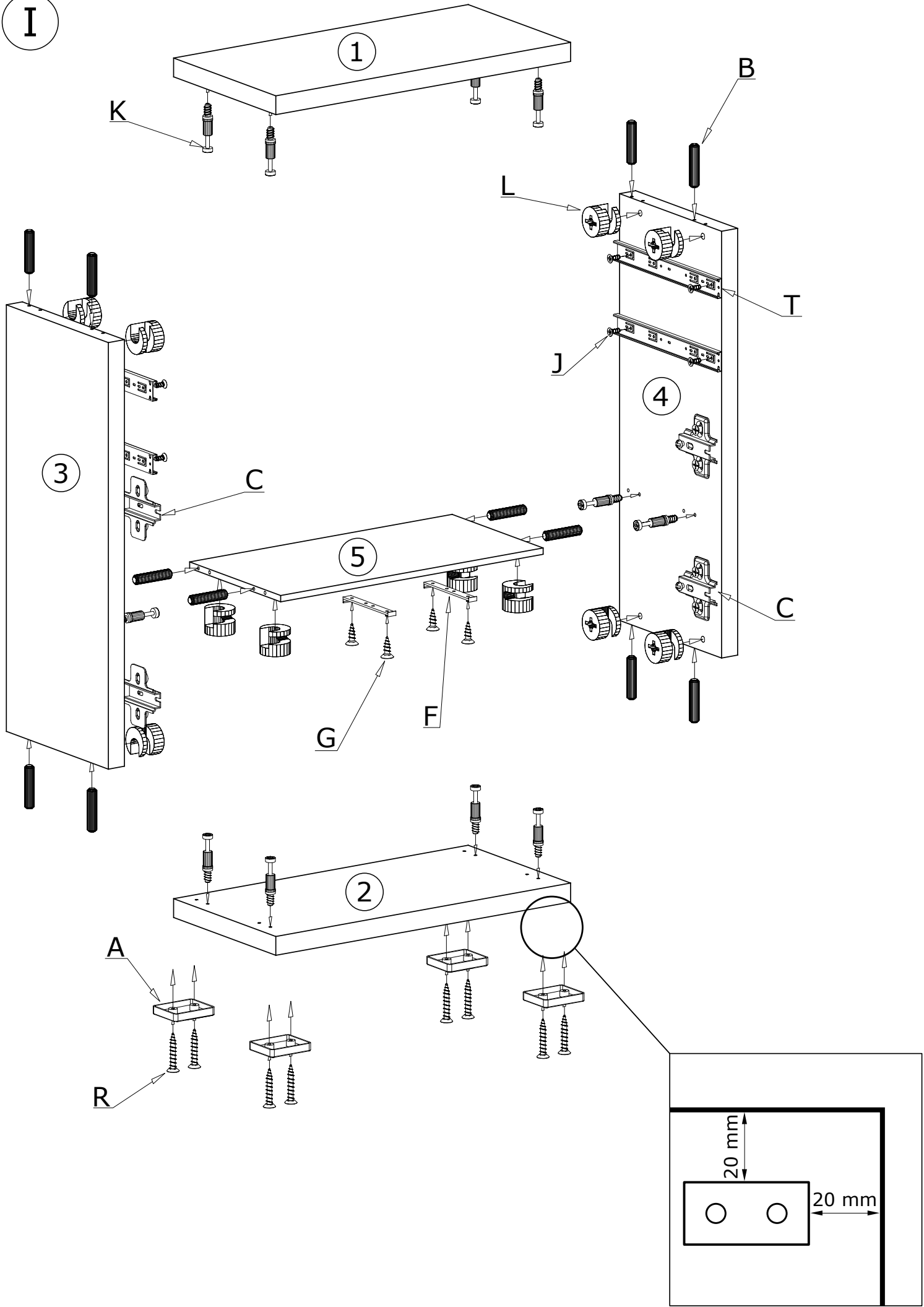

1

K

B

L

T

3

C

4

J

5

F

G

2

A

R

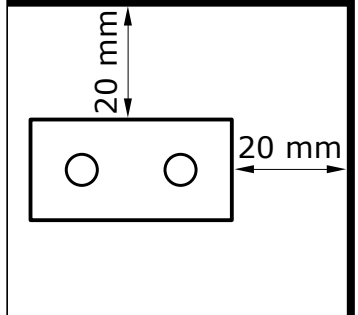

II

60X 

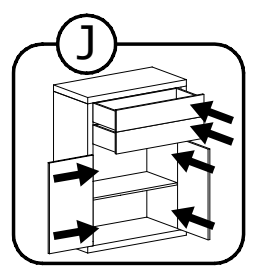
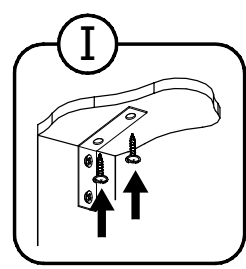
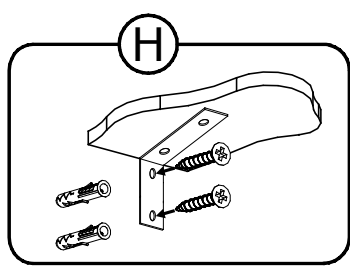
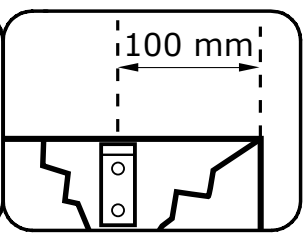
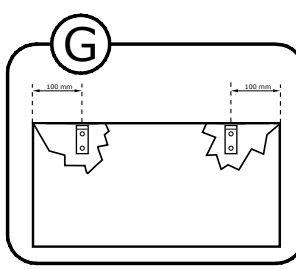
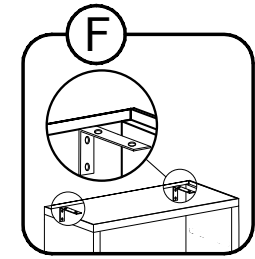
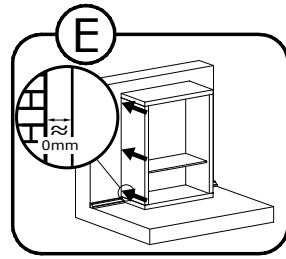
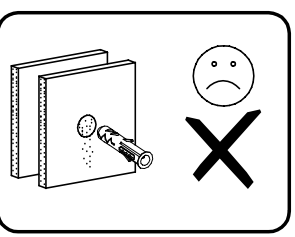
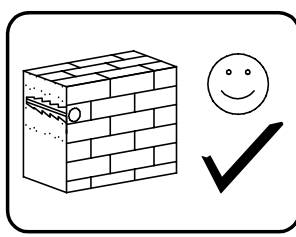
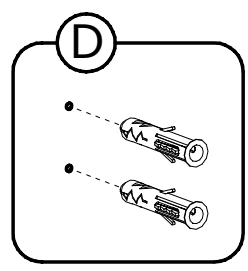
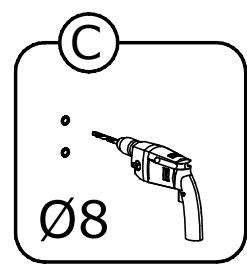
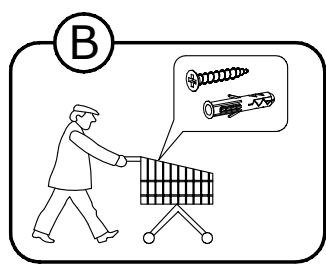
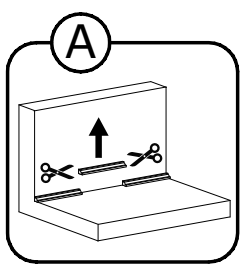
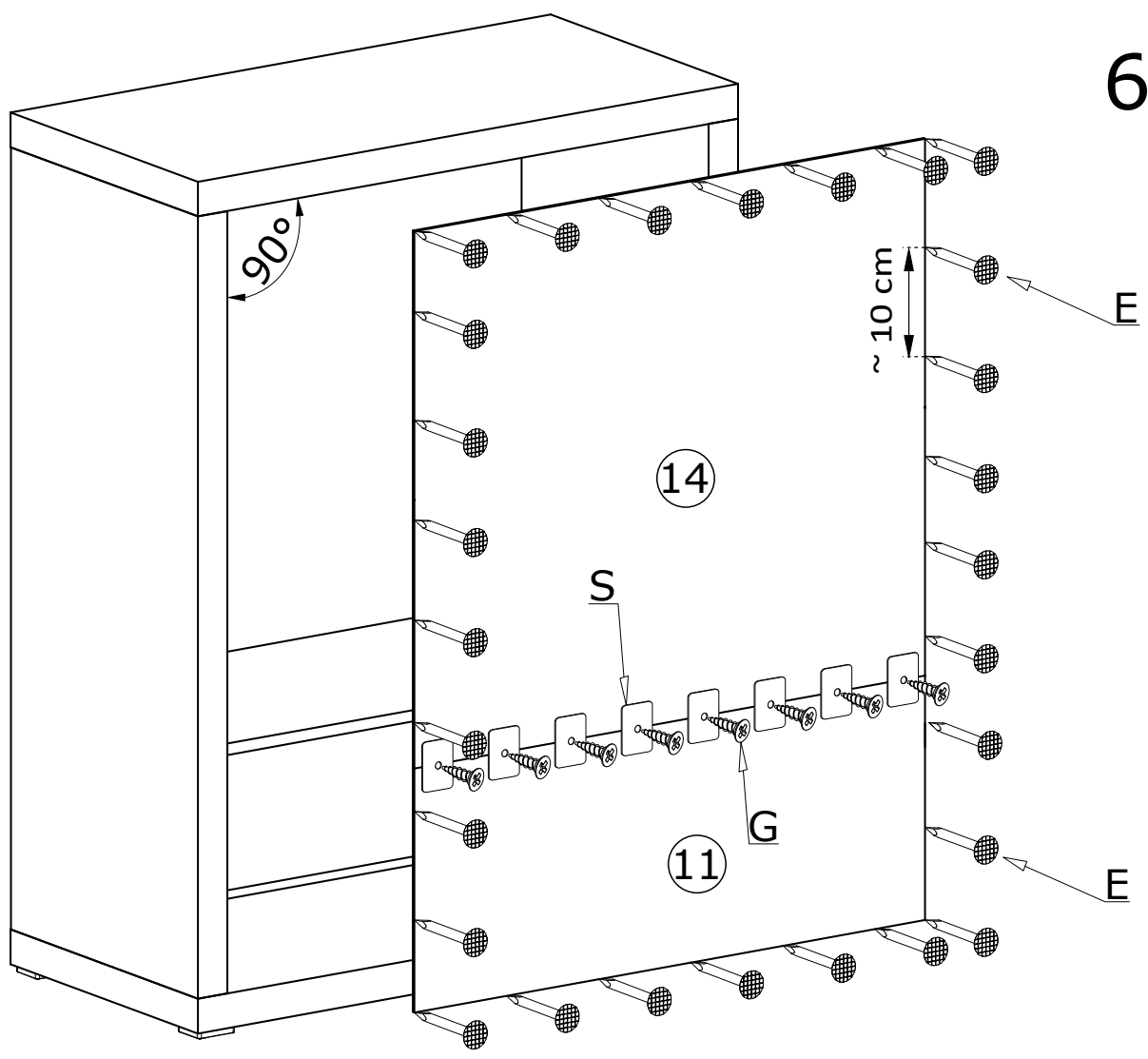

III

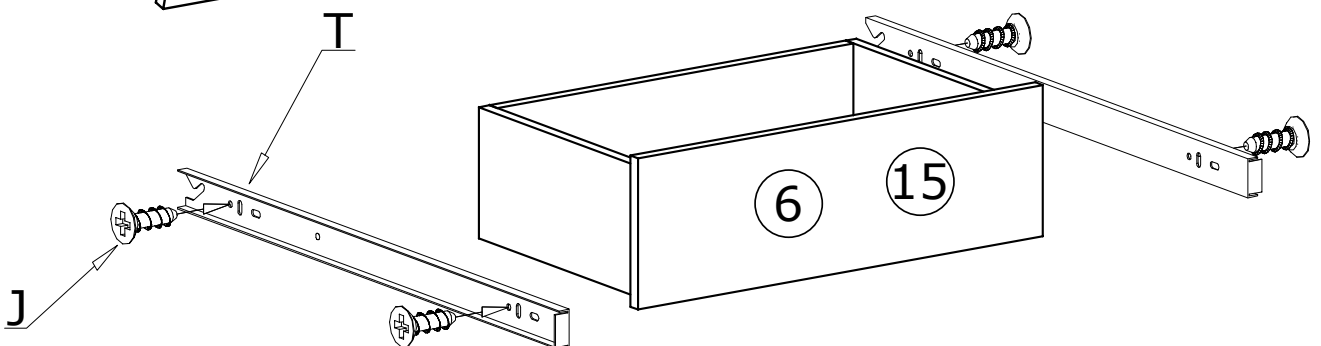
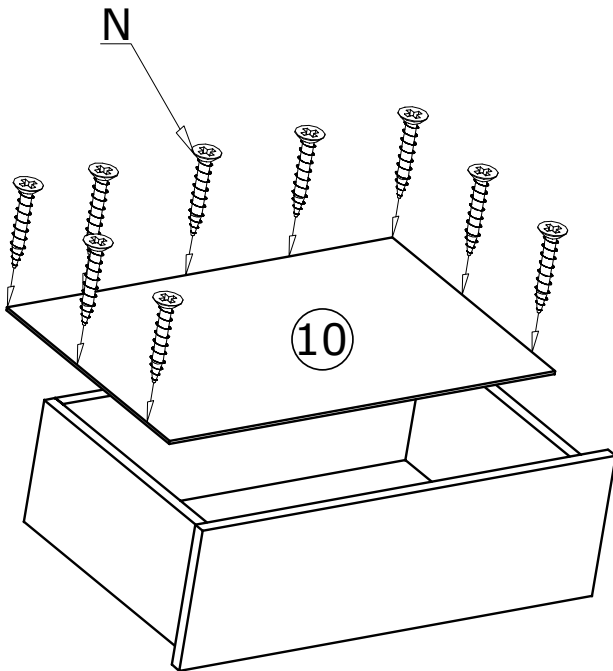
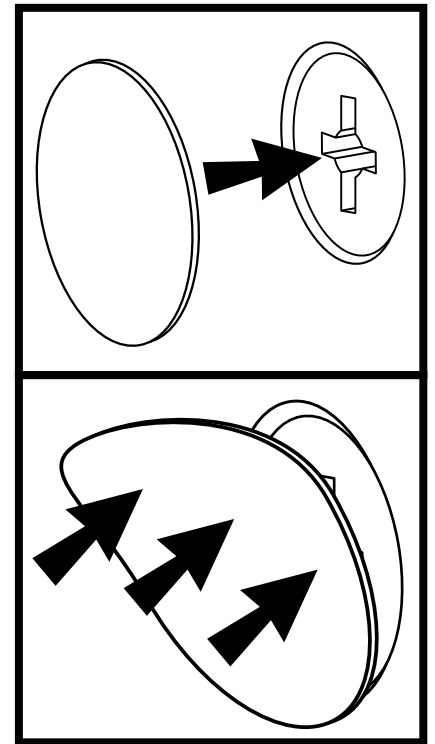
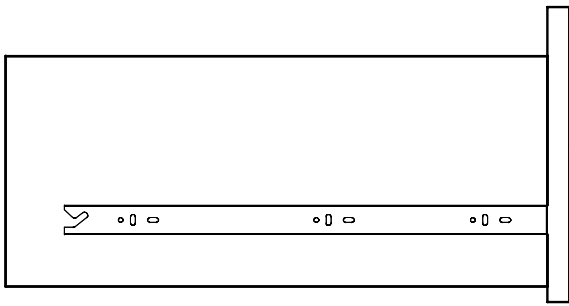
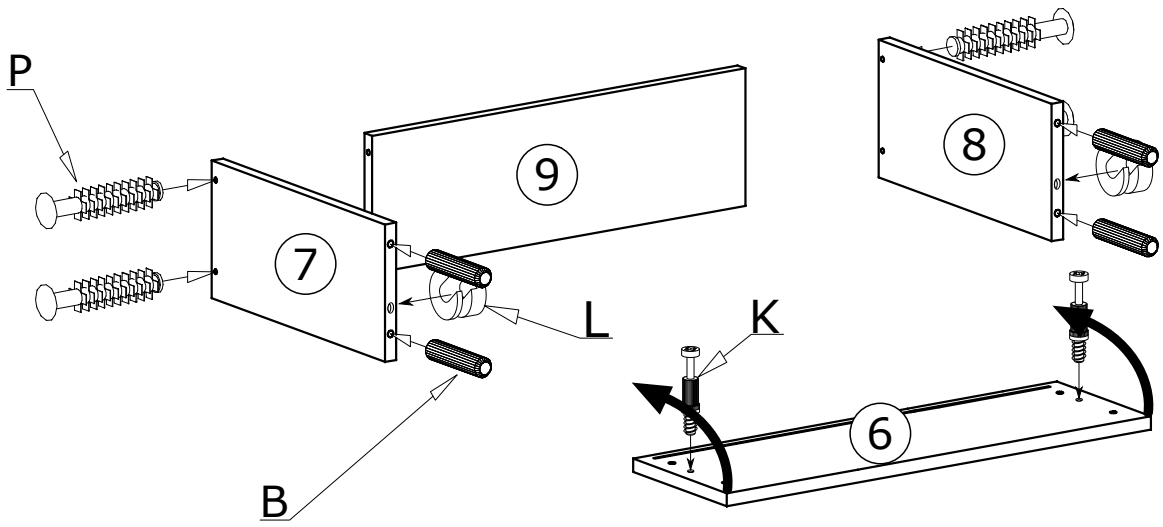

IV

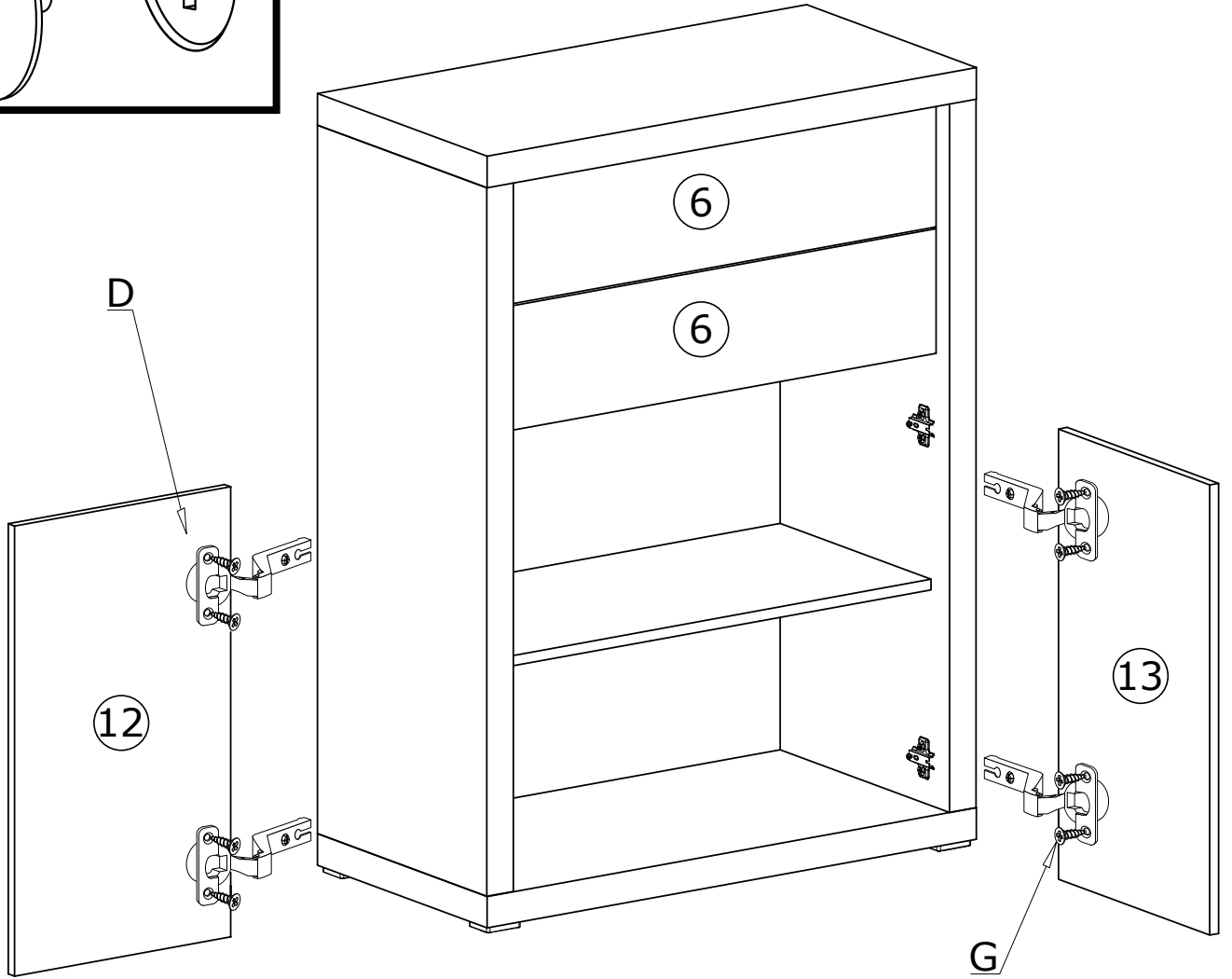
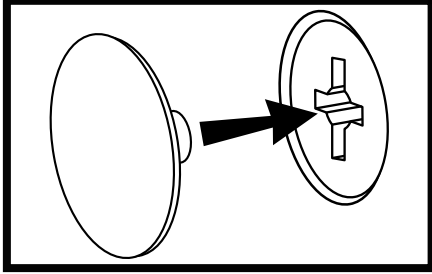
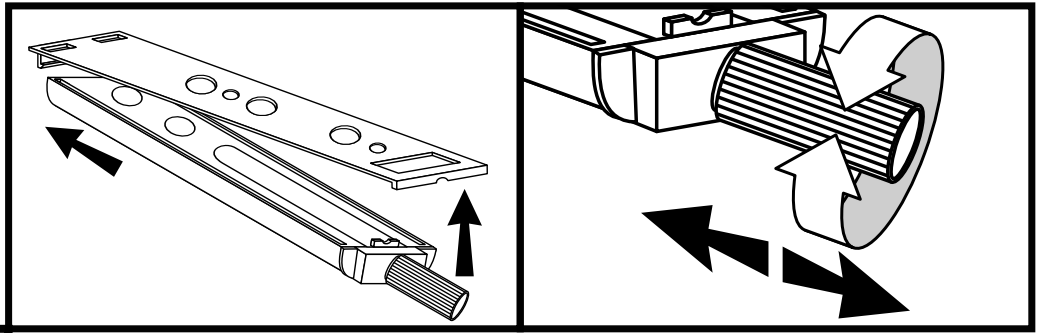

MONTAŻ/DEMONTAŻ PROWADNIC

1



2



3

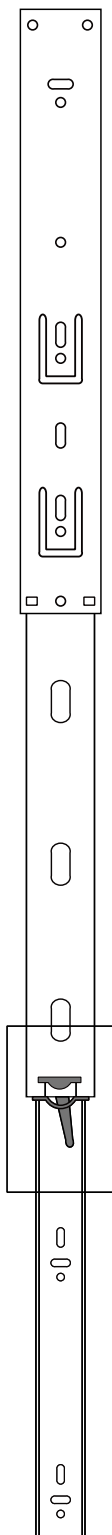

4

