

PARIS 7

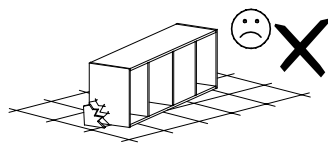

Narzędzia potrzebne do montażu



UWAGA !!!

MONTOWANIE USZKODZONYCH
ELEMENTÓW POWODUJE UTRATĘ
GWARANCJI

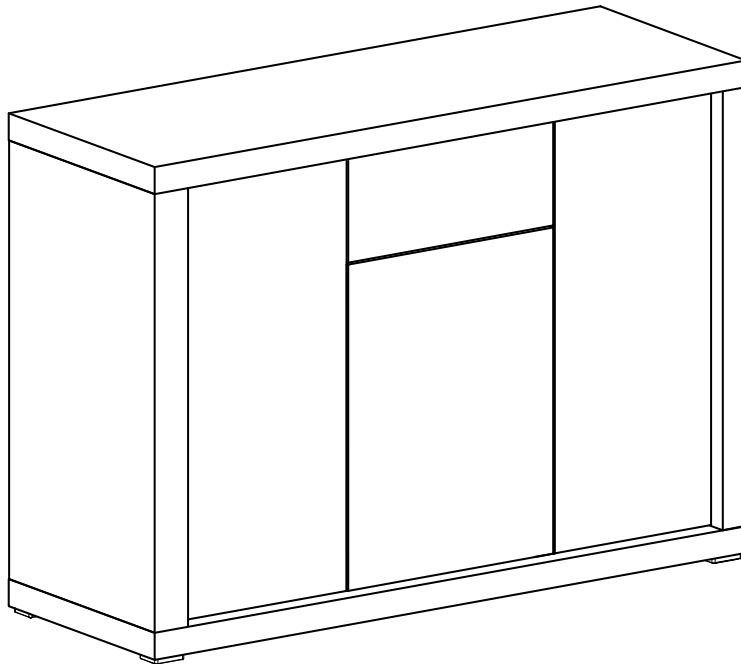

Nr	D[mm]	S[mm]	G[mm]	Ilość
1	1276	436	48	1
2	1276	436	48	1
3	780	435	48	1
4	780	388	16	1
5	780	388	16	1
6	780	435	48	1
7	393	312	16	2
8	417	312	16	1
9	1265	834	2,5	1
10	430	580	16	1
11	390	355	2,5	1
12	430	190	16	1
13	350	165	16	1
14	350	165	16	1
15	360	165	16	1
16	773	368	16	1
17	773	368	16	1

W przypadku reklamacji proszę podać numer pakowacza znajdujący się na kartonie.

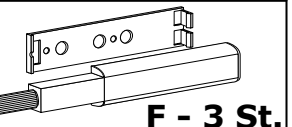
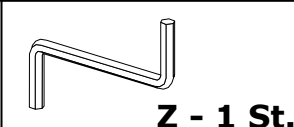
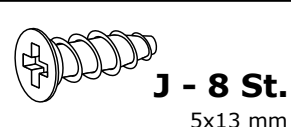
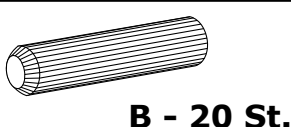
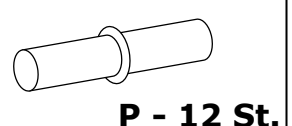
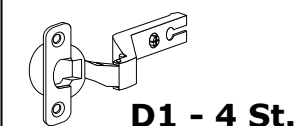
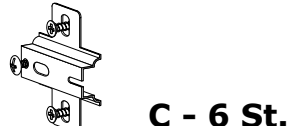
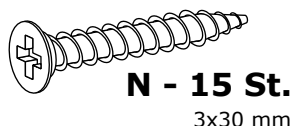
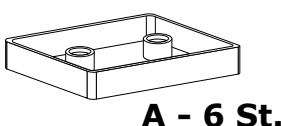
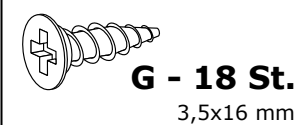
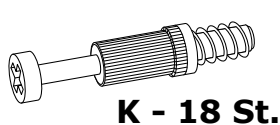
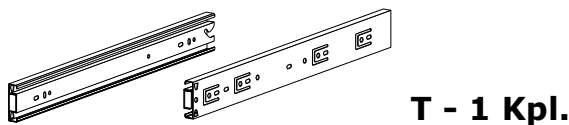
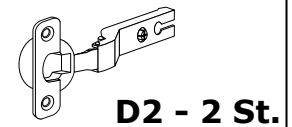
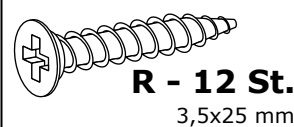
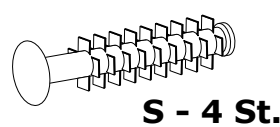
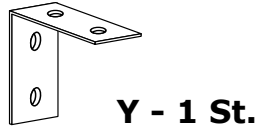
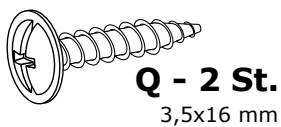
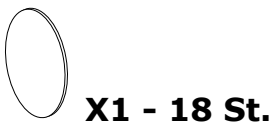

I

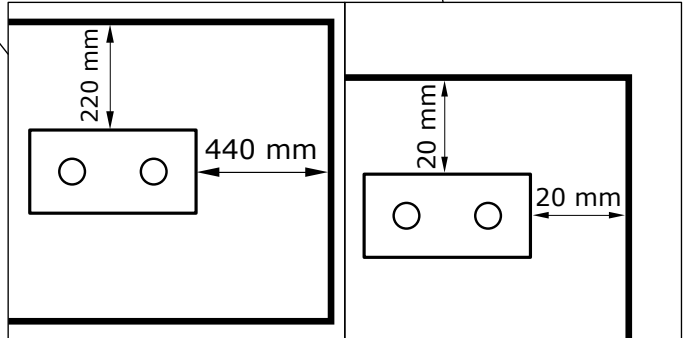
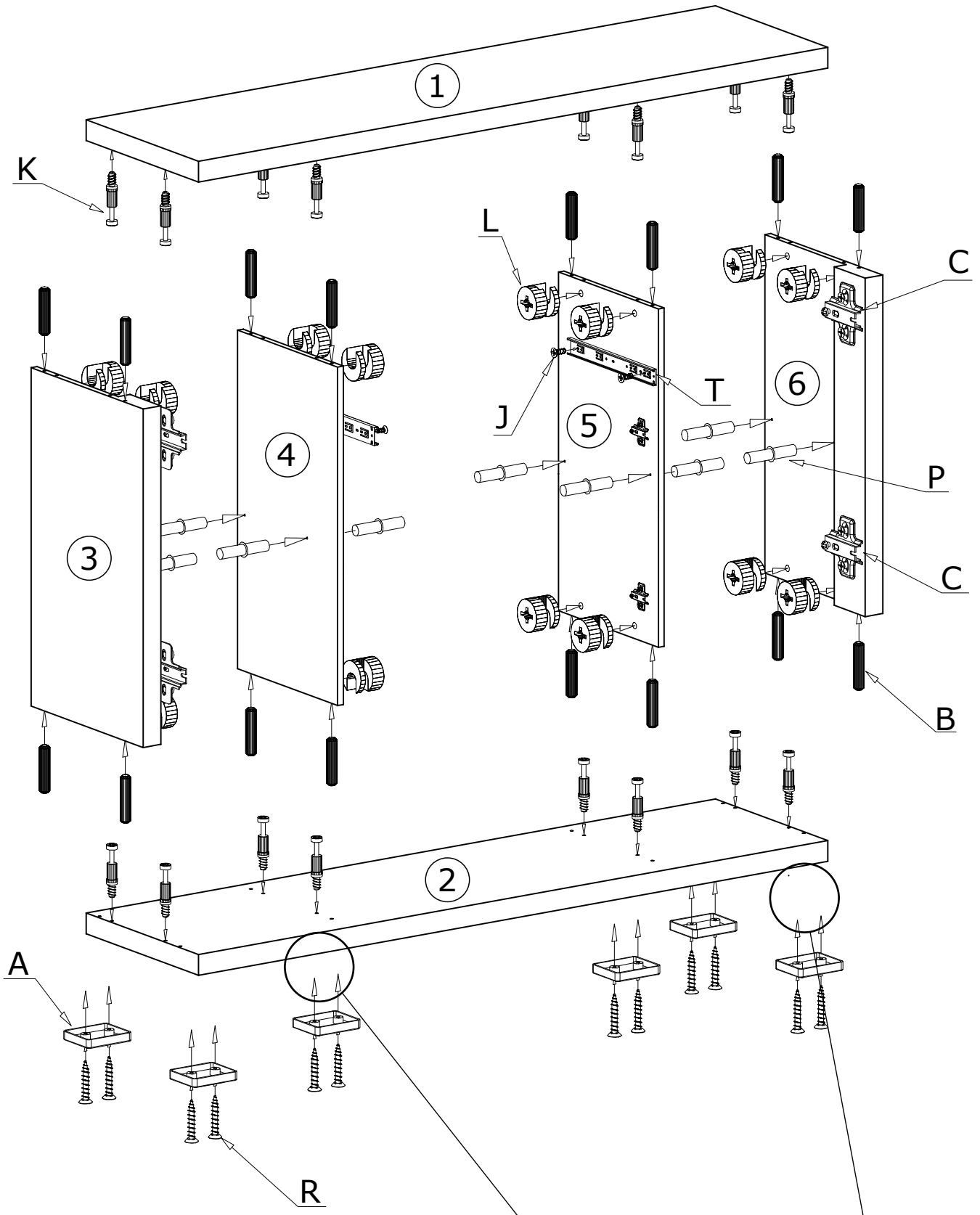

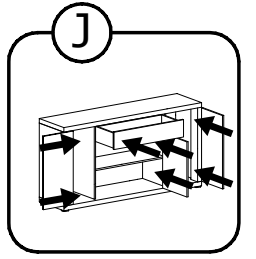
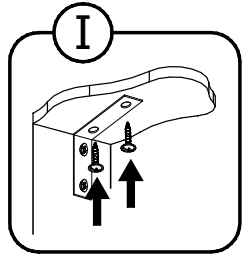
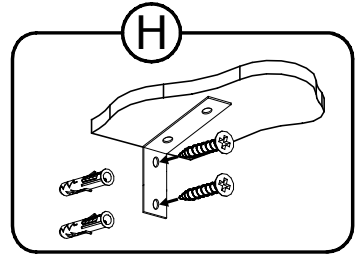
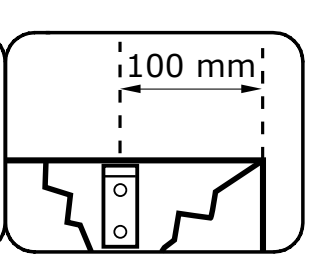
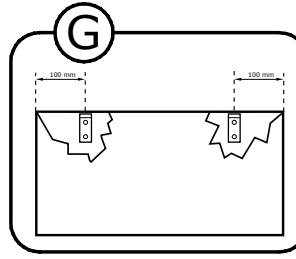
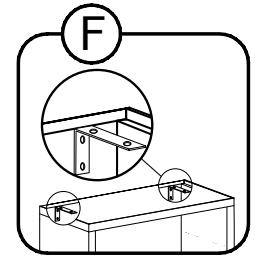
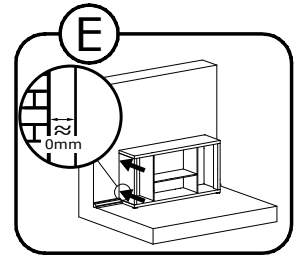
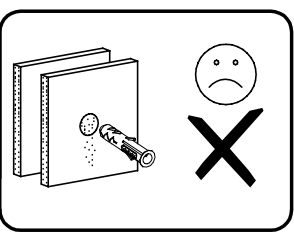
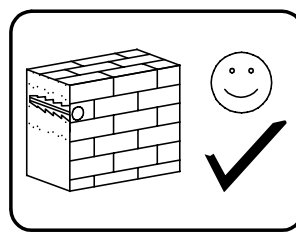
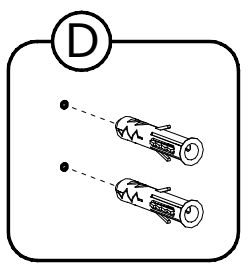
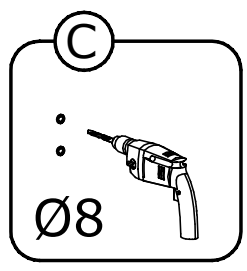
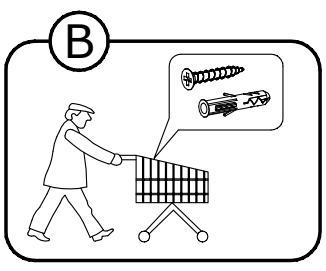
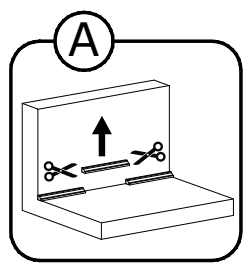
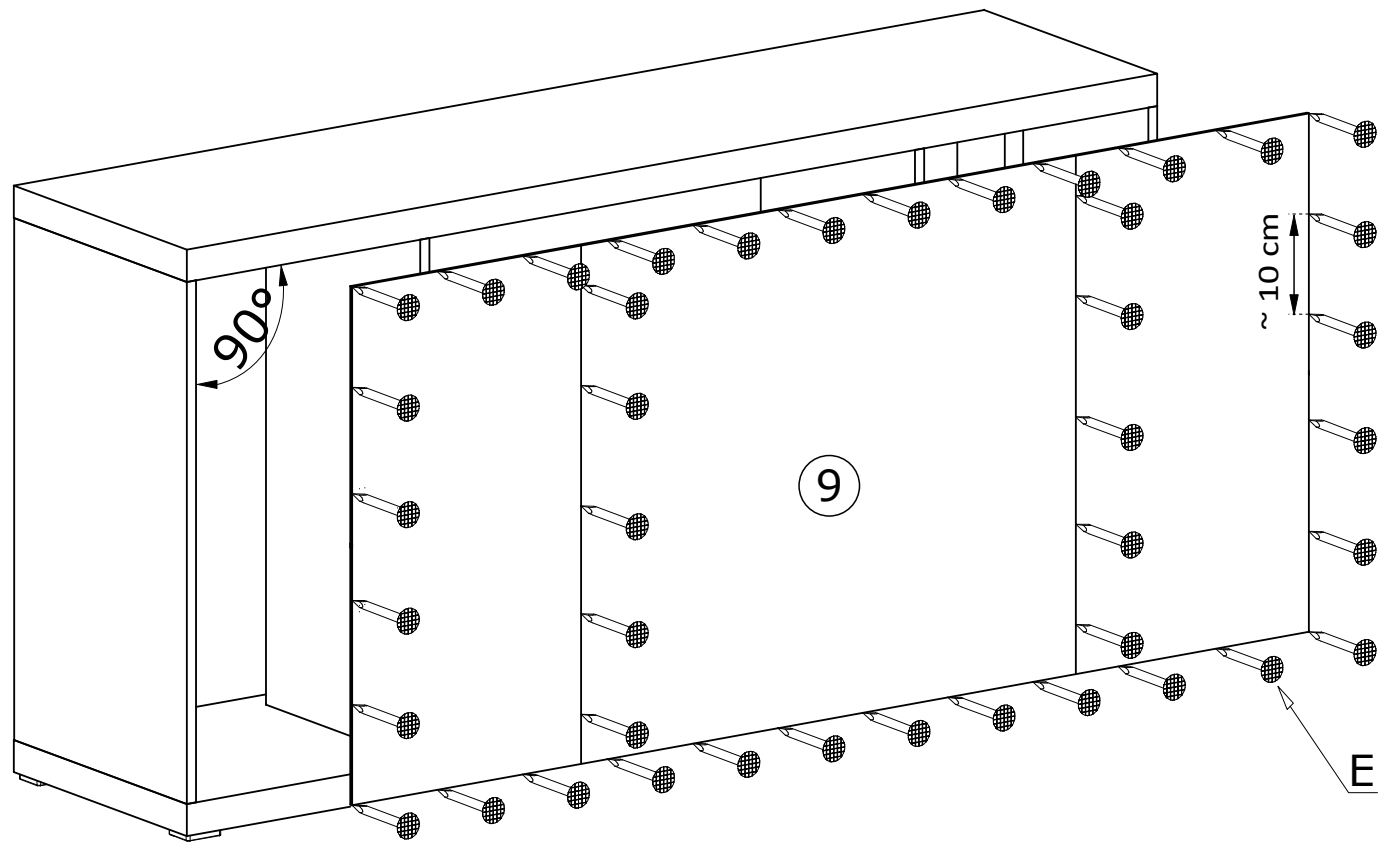

III

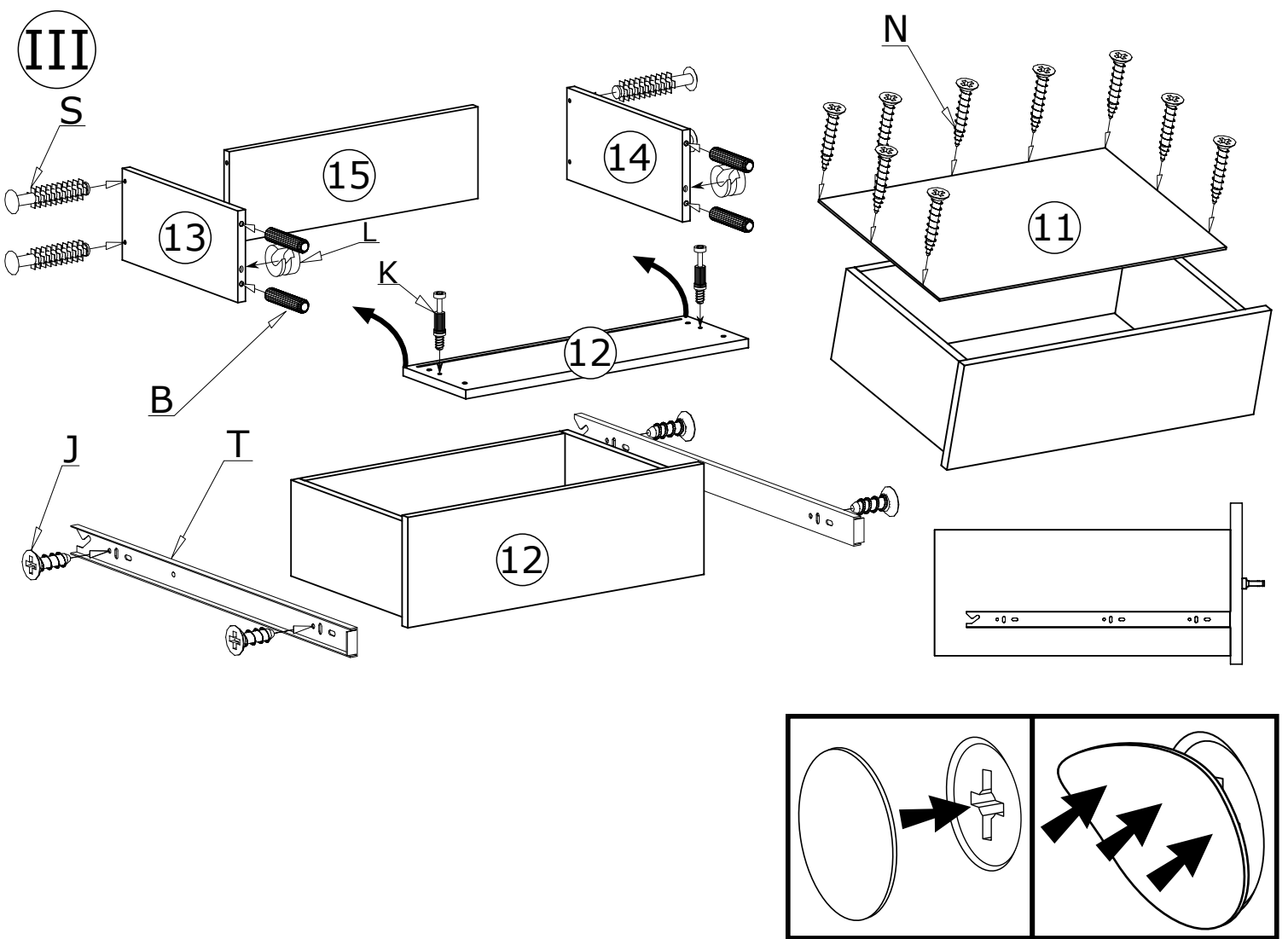

IV

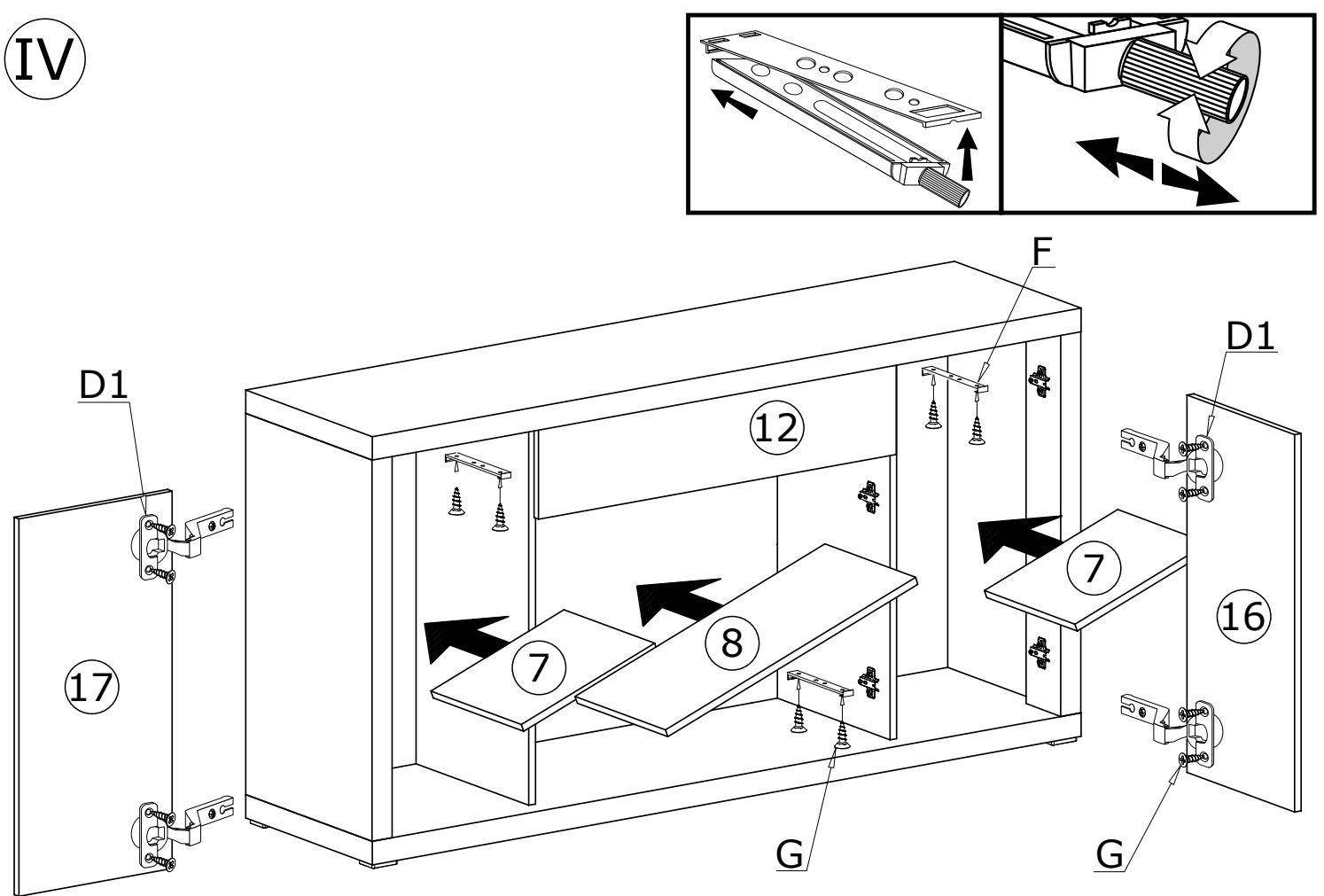

V

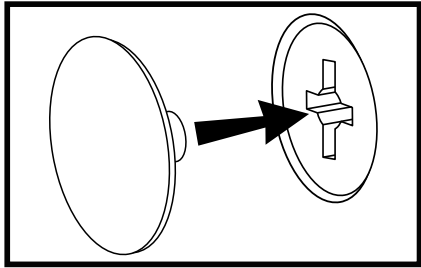

D1

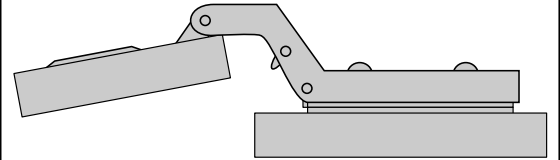

D2

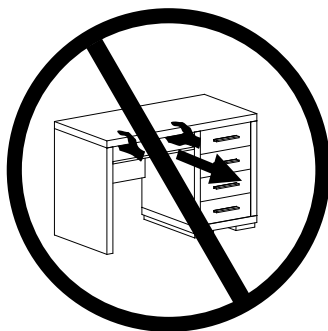
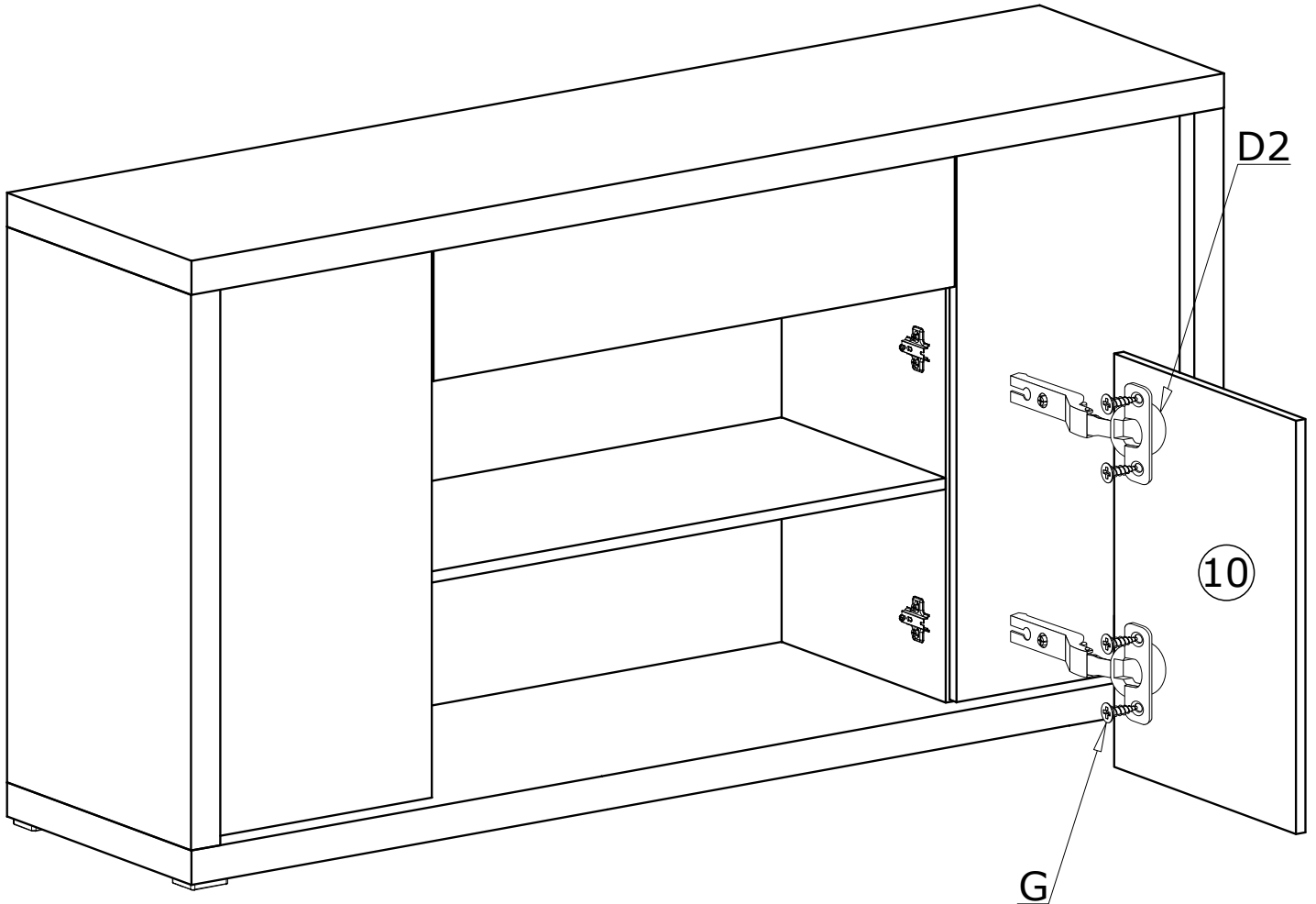
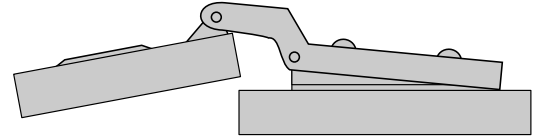

MONTAŻ/DEMONTAŻ PROWADNIC

1



2



3

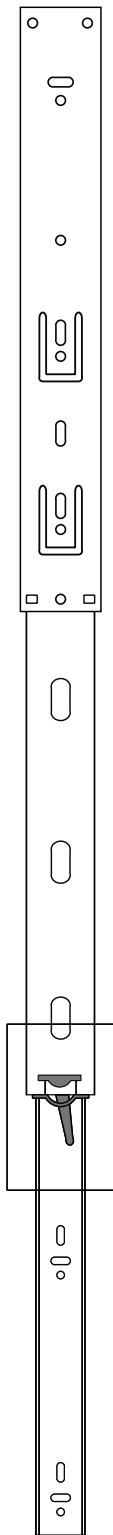

4

