

PARIS 4

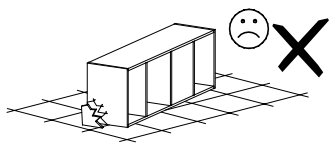

Narzędzia potrzebne do montażu

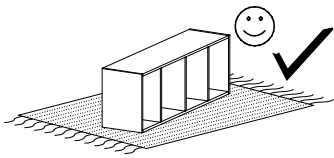
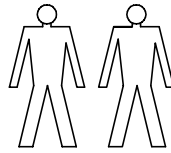
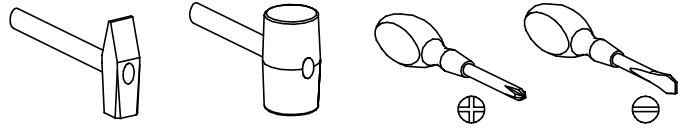

UWAGA !!!

MONTOWANIE USZKODZONYCH
ELEMENTÓW POWODUJE UTRATĘ
GWARANCJI

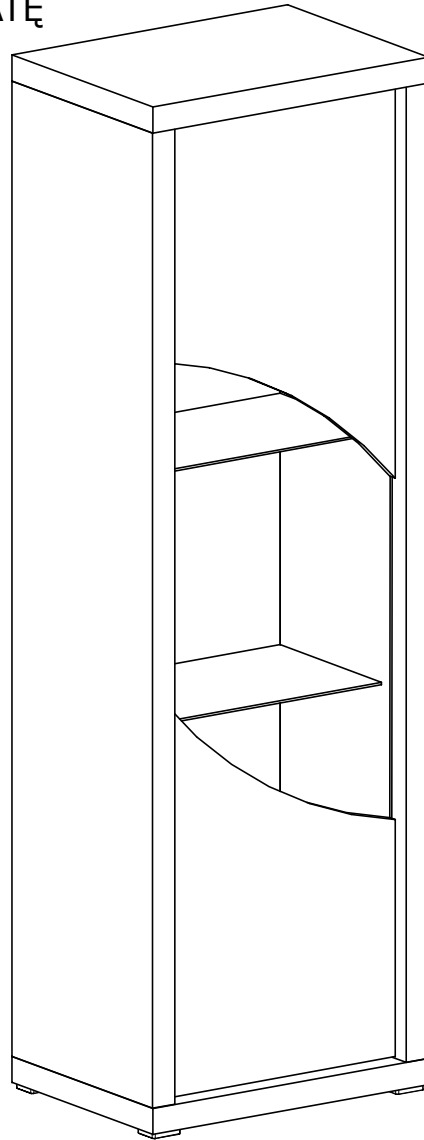

Nr	D[mm]	S[mm]	G[mm]	Ilość
1	602	436	48	1
2	602	436	48	1
3	503	370	16	2
4	1790	435	48	1
5	1790	435	48	1
6	1840	590	2,5	1
7	955	495	4	1
8	497	720	16	1
9	497	720	16	1
10	500	370	4	2



X2 - 1 St.
Ø5 mm



X1 - 16 St.

W przypadku reklamacji proszę podać numer pakowacza znajdujący się na kartonie.

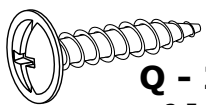

Q - 2 St.
3,5x16 mm

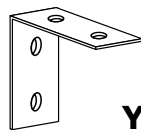

Y - 1 St.

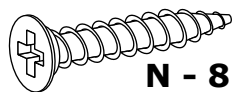

N - 8 St.
3,5x25 mm

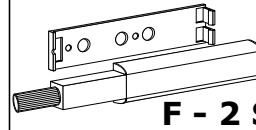

F - 2 St.

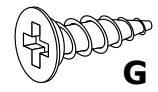

G - 20 St.
3,5x16 mm

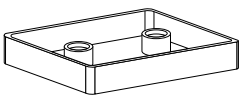

A - 4 St.

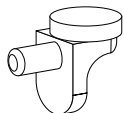

S - 9 St.

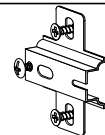

C - 4 St.

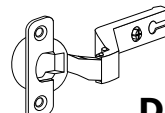

D - 4 St.



L - 16 St.



E - 60 St.

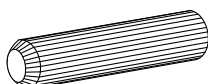

B - 16 St.

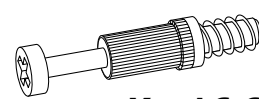

K - 16 St.

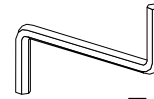

Z - 1 St.

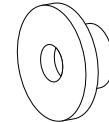

R - 8 St.

I

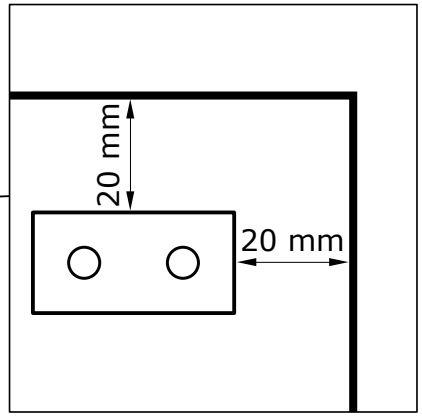
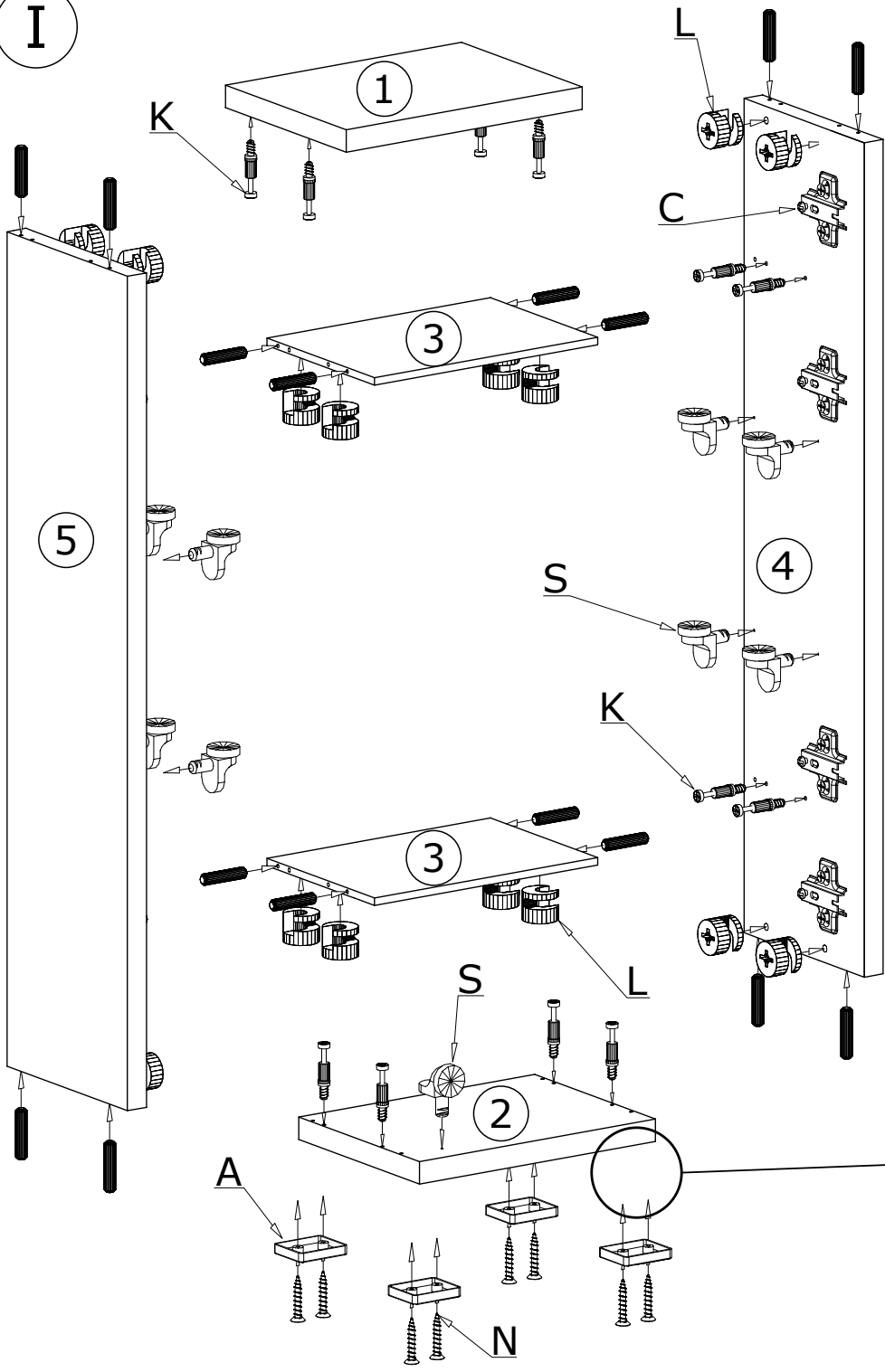

II

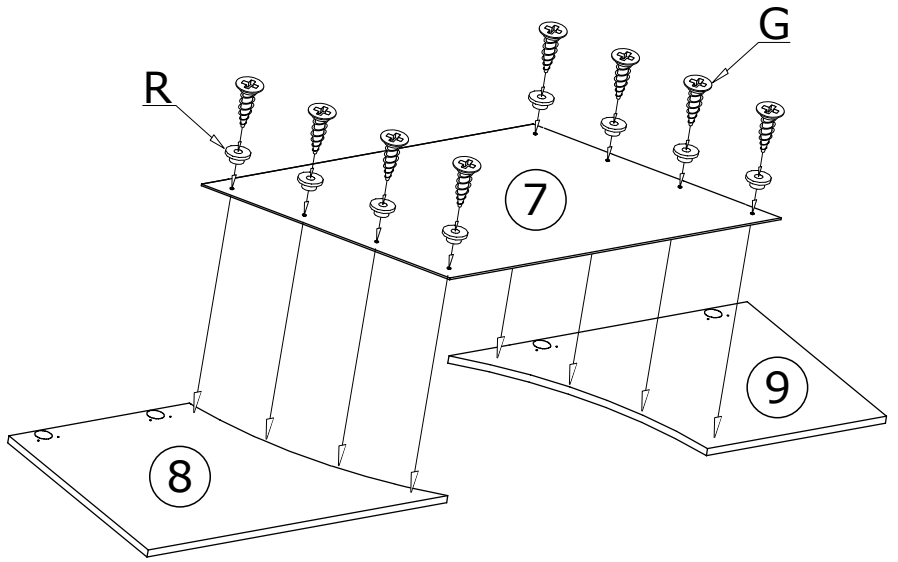
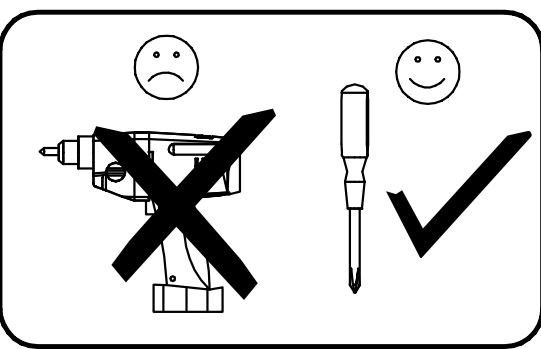

III

60X

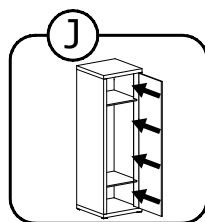
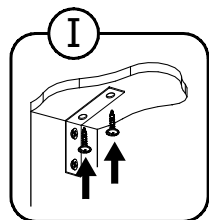
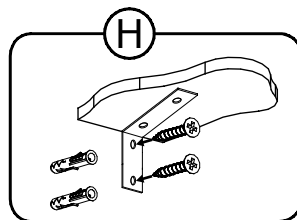
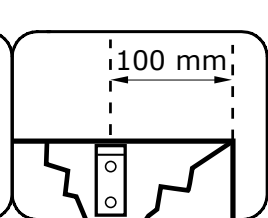
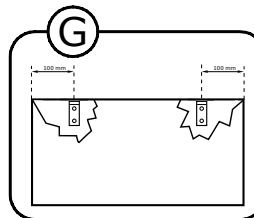
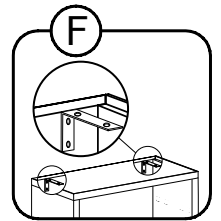
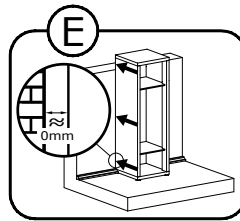
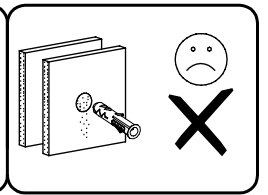
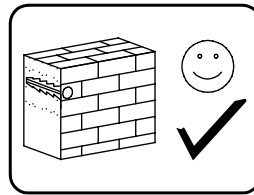
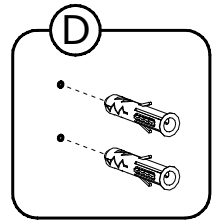
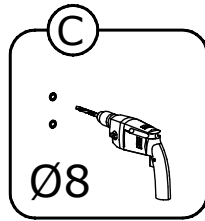
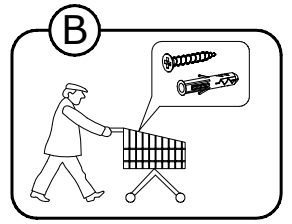
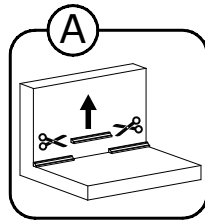
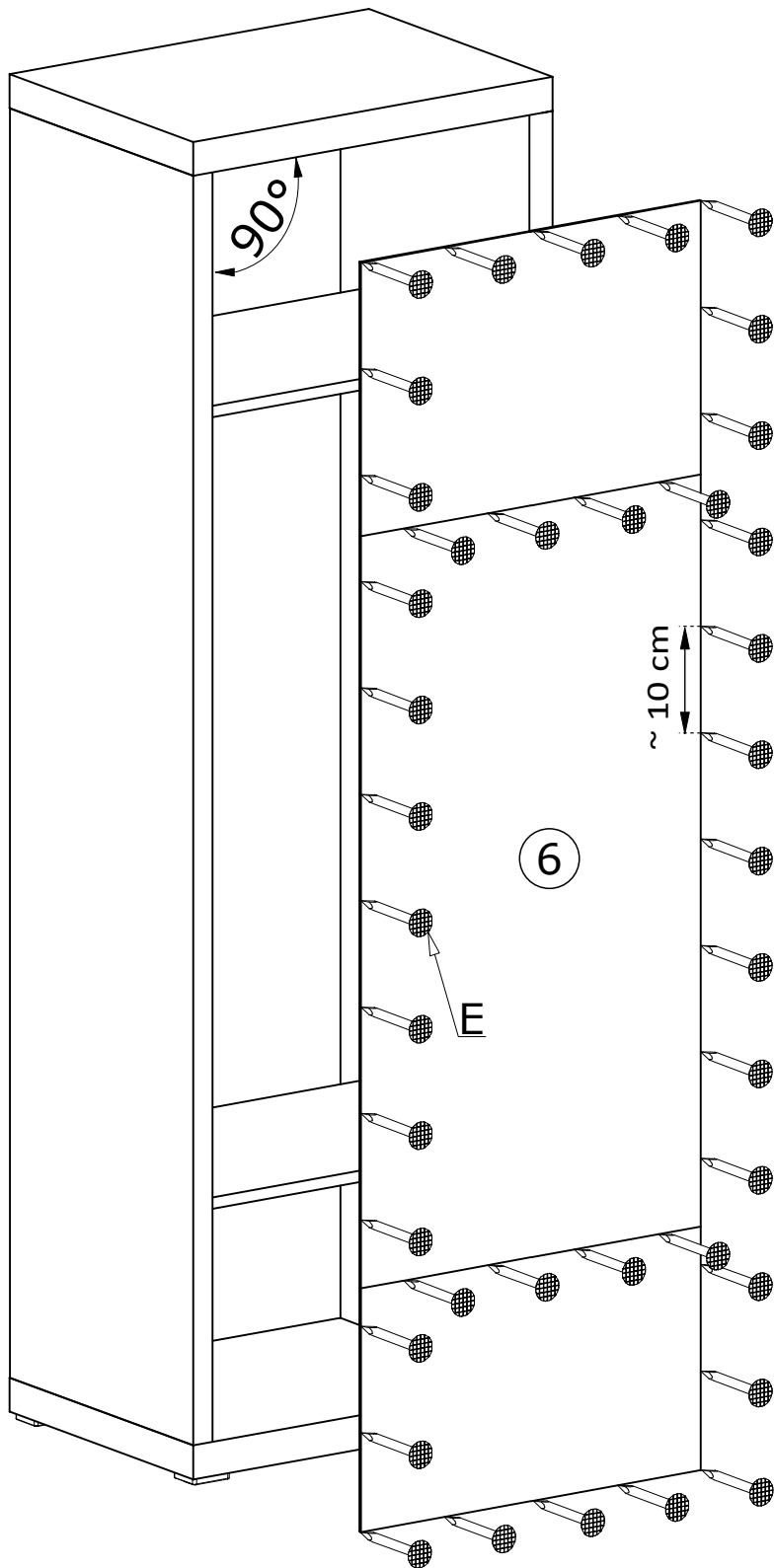

IV

