

PARIS 3

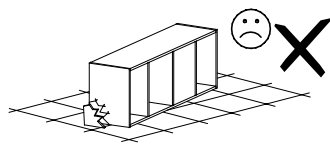

Narzędzia potrzebne do montażu

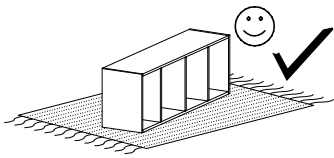
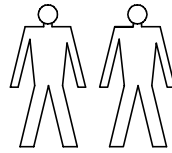
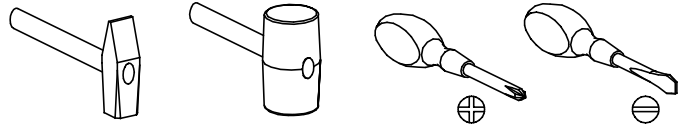

UWAGA !!!

MONTOWANIE USZKODZONYCH
ELEMENTÓW POWODUJE UTRATĘ
GWARANCJI

Nr	D[mm]	S[mm]	G[mm]	Ilość
1	882	436	48	1
2	882	436	48	1
3	782	370	16	2
4	1790	435	48	1
5	1790	435	48	1
6	1840	872	2,5	1
7	955	495	4	1
8	497	720	16	1
9	497	720	16	1
10	1784	278	16	1
11	780	370	4	2

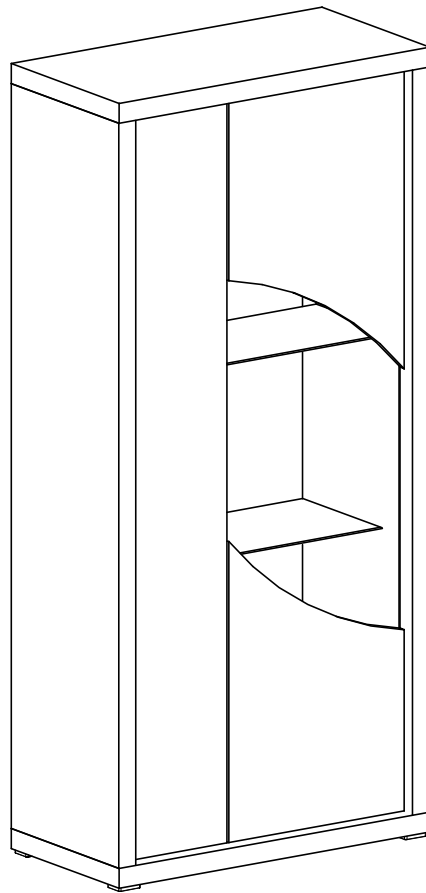

W przypadku reklamacji proszę podać numer pakowacza znajdujący się na kartonie.



X1 - 16 St.

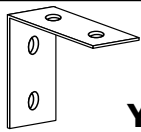

Y - 1 St.

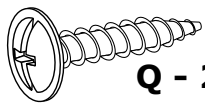

Q - 2 St.
3,5x16 mm

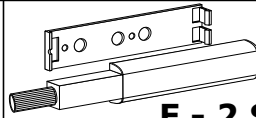

F - 2 St.

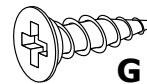

G - 26 St.
3,5x16 mm

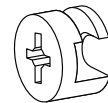

L - 16 St.

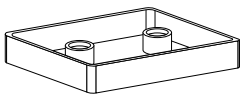

A - 4 St.

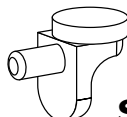

S - 10 St.

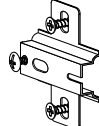

C - 7 St.

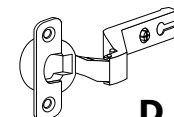

D - 7 St.

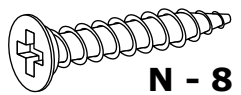

N - 8 St.
3,5x25 mm

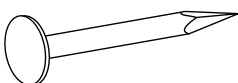

E - 80 St.

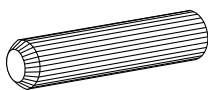

B - 16 St.

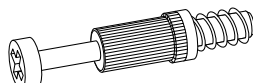

K - 16 St.



Z - 1 St.

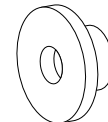

R - 8 St.

I

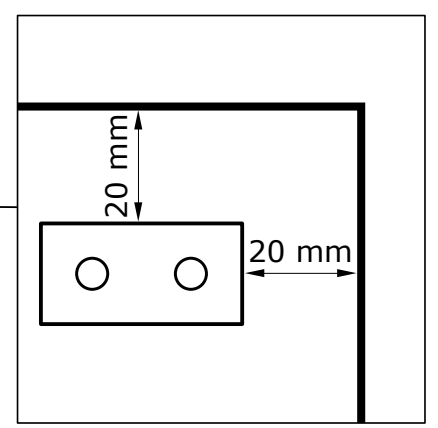
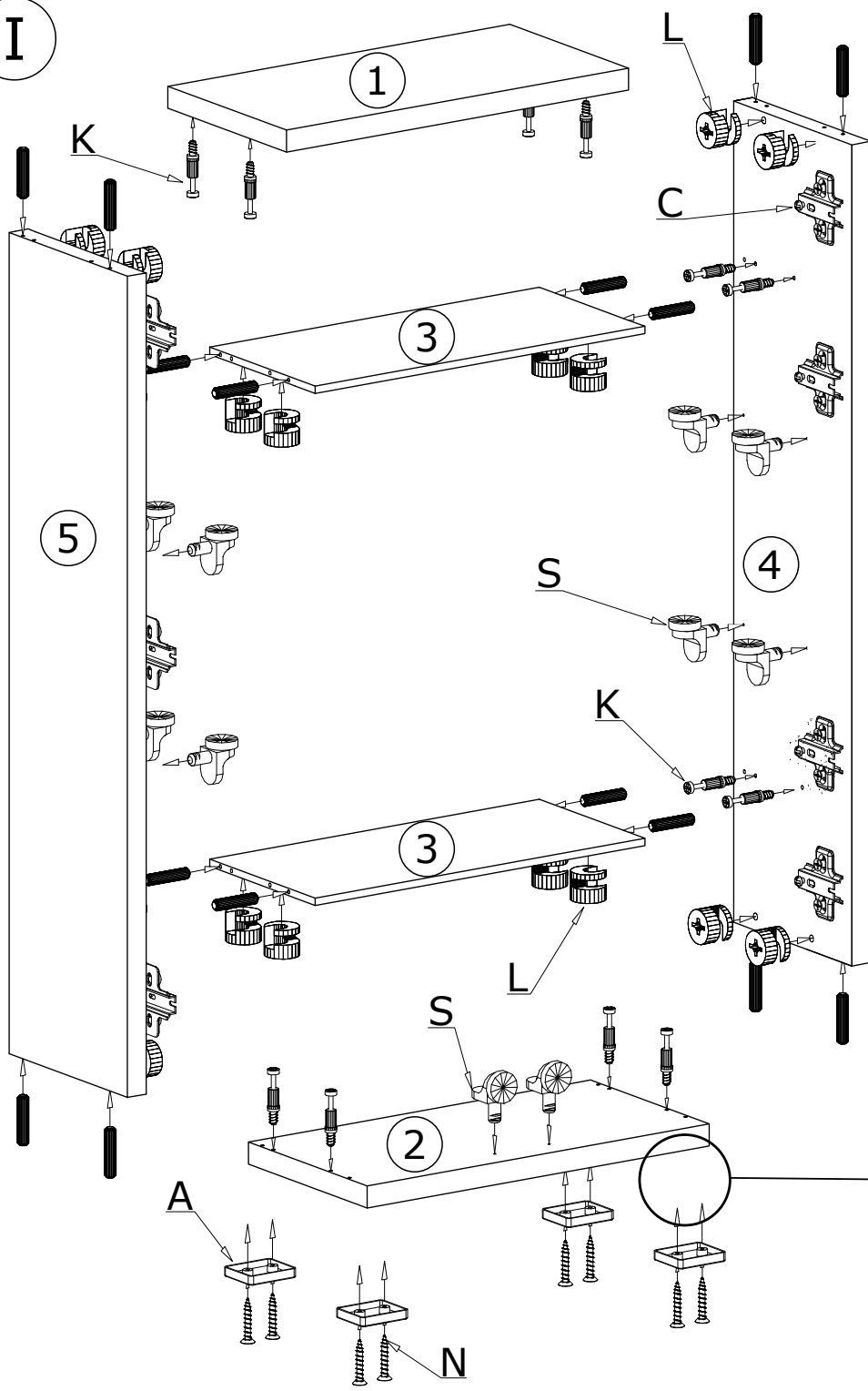

II

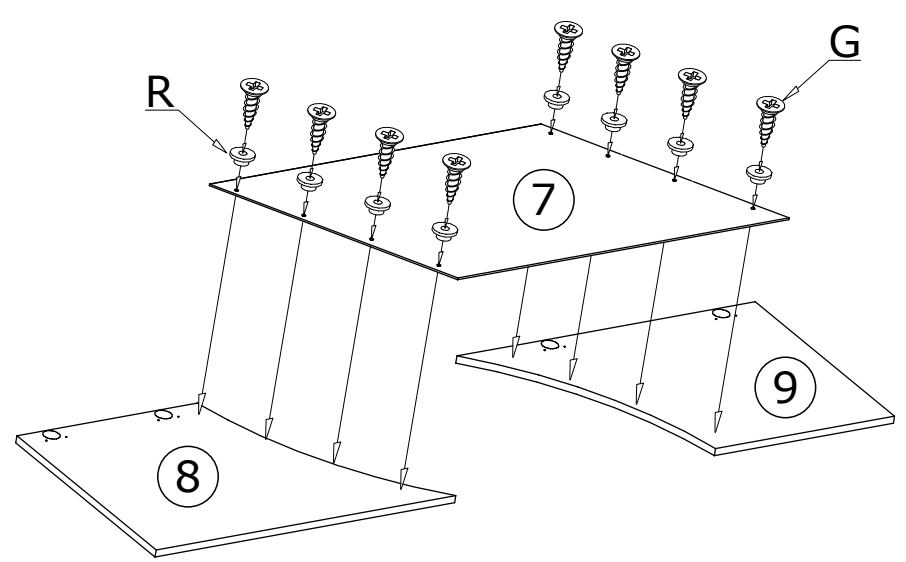
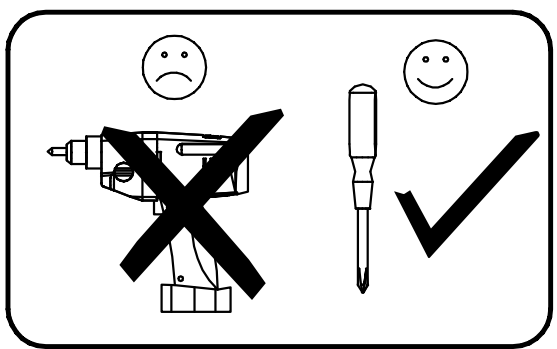

III

80X

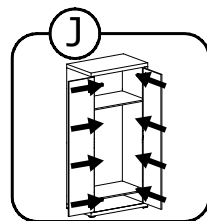
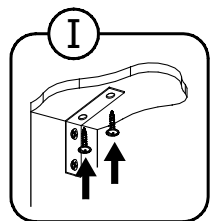
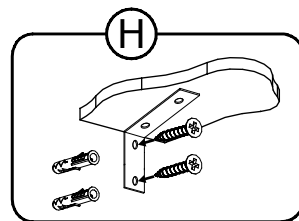
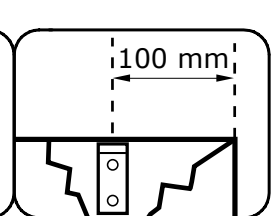
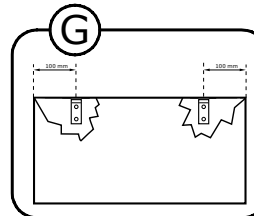
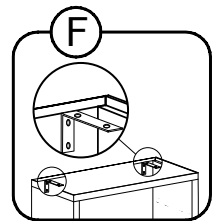
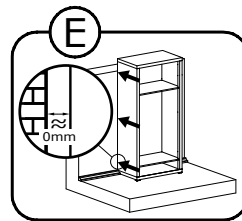
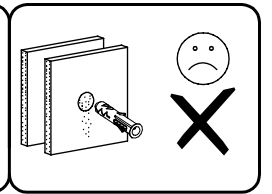
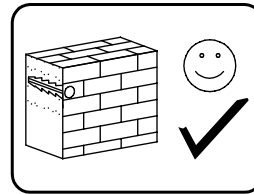
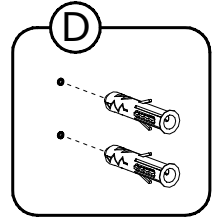
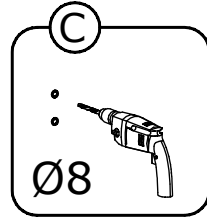
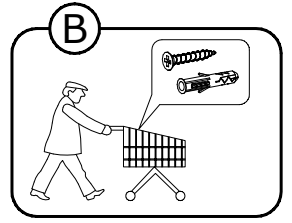
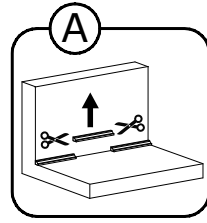
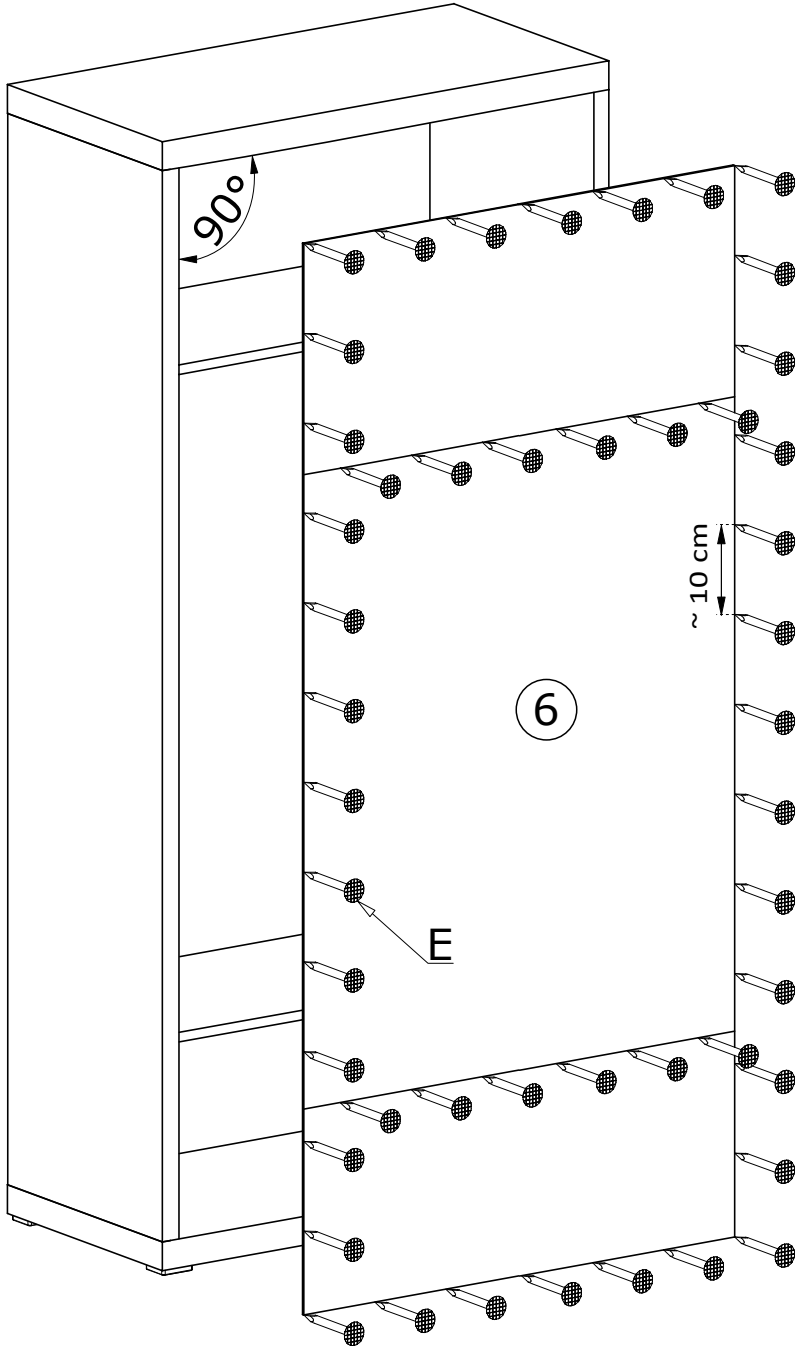

IV

