

PARIS 2

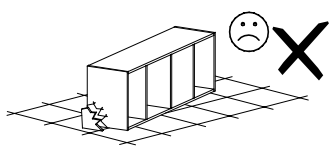

Narzędzia potrzebne do montażu

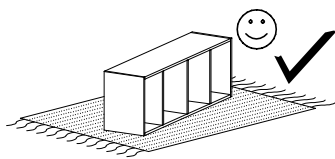
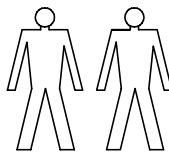

UWAGA !!!

MONTOWANIE USZKODZONYCH
ELEMENTÓW POWODUJE UTRATĘ
GWARANCJI

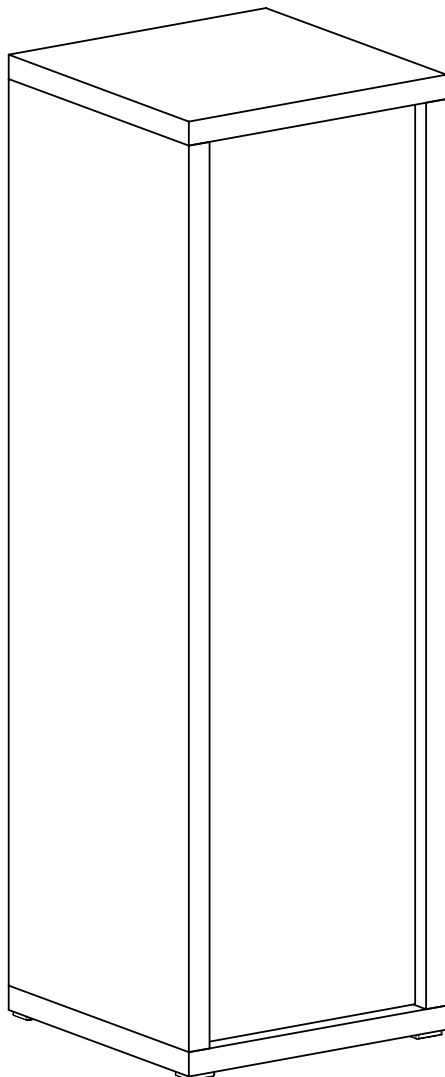

Nr	D[mm]	S[mm]	G[mm]	Ilość
1	602	602	48	1
2	602	602	48	1
3	568	553	16	1
4	1790	600	48	1
5	1790	600	48	1
6	1840	590	2,5	1
7	1784	498	16	1

W przypadku reklamacji proszę podać numer pakowacza znajdujący się na kartonie.

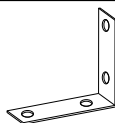

Y - 2 St.

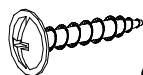

Q - 4 St.
3,5x16 mm

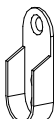

Y - 2 St.



R - 1 St.
560 mm

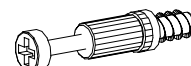

K - 16 St.

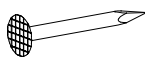

E - 60 St.

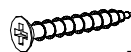

M - 8 St.
3,5x25 mm

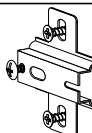

C - 4 St.

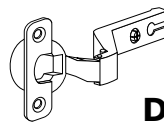

D - 4 St.

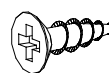

G - 14 St.
3,5x16 mm

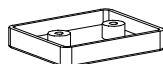

A - 4 St.



B - 16 St.



L - 16 St.

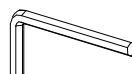

Z - 1 St.

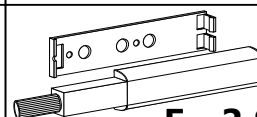

F - 2 St.

I

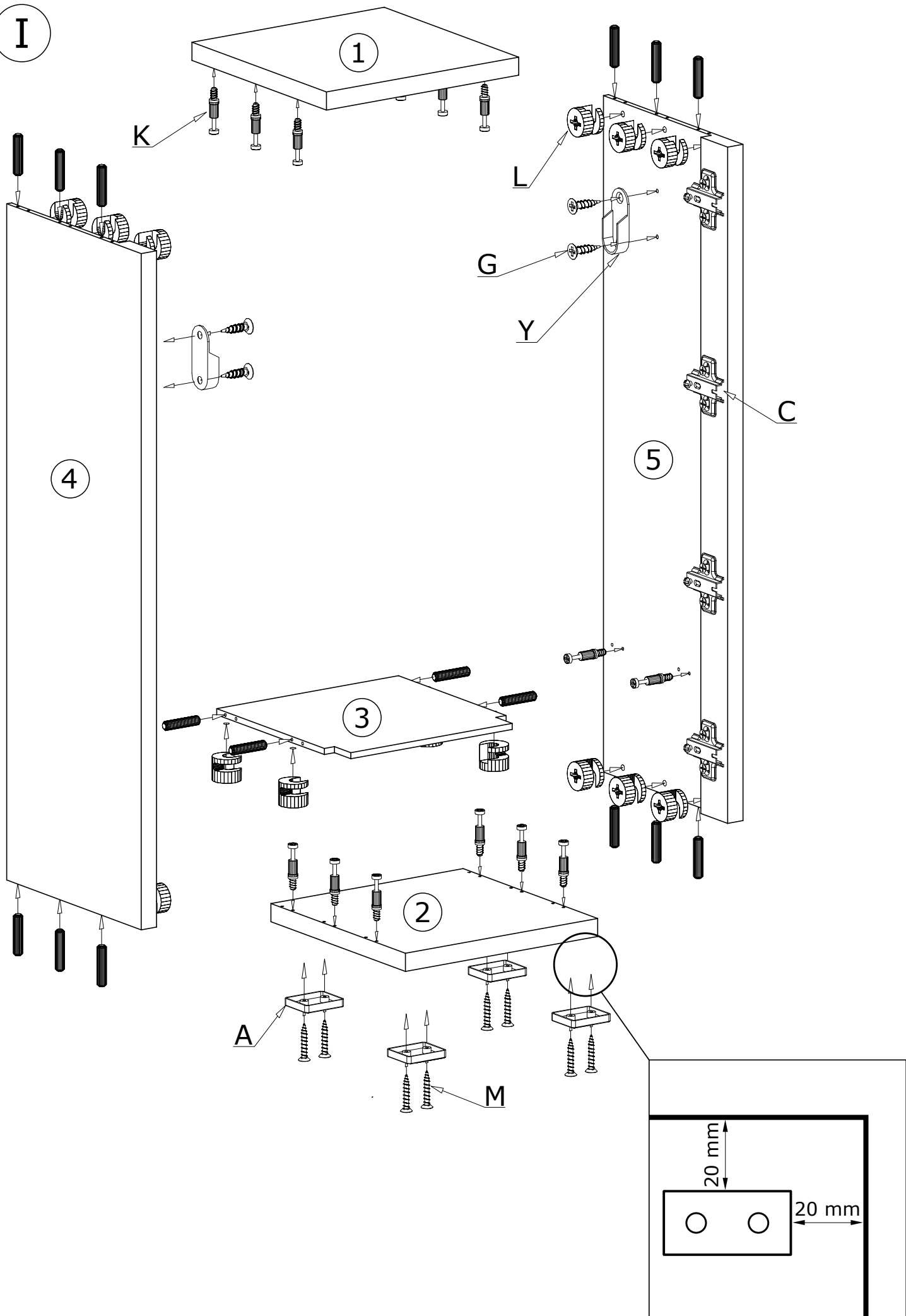

II

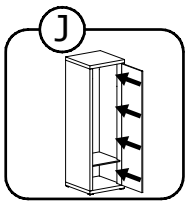
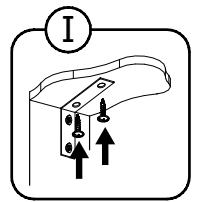
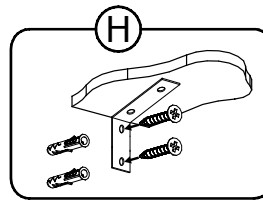
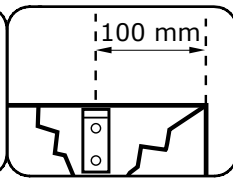
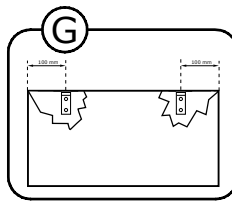
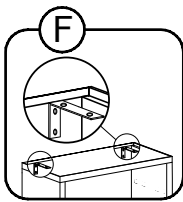
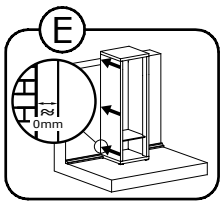
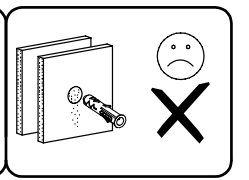
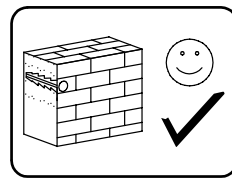
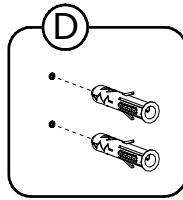
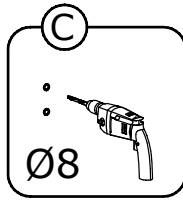
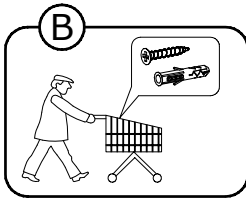
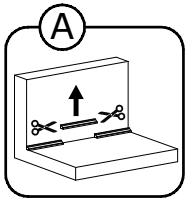
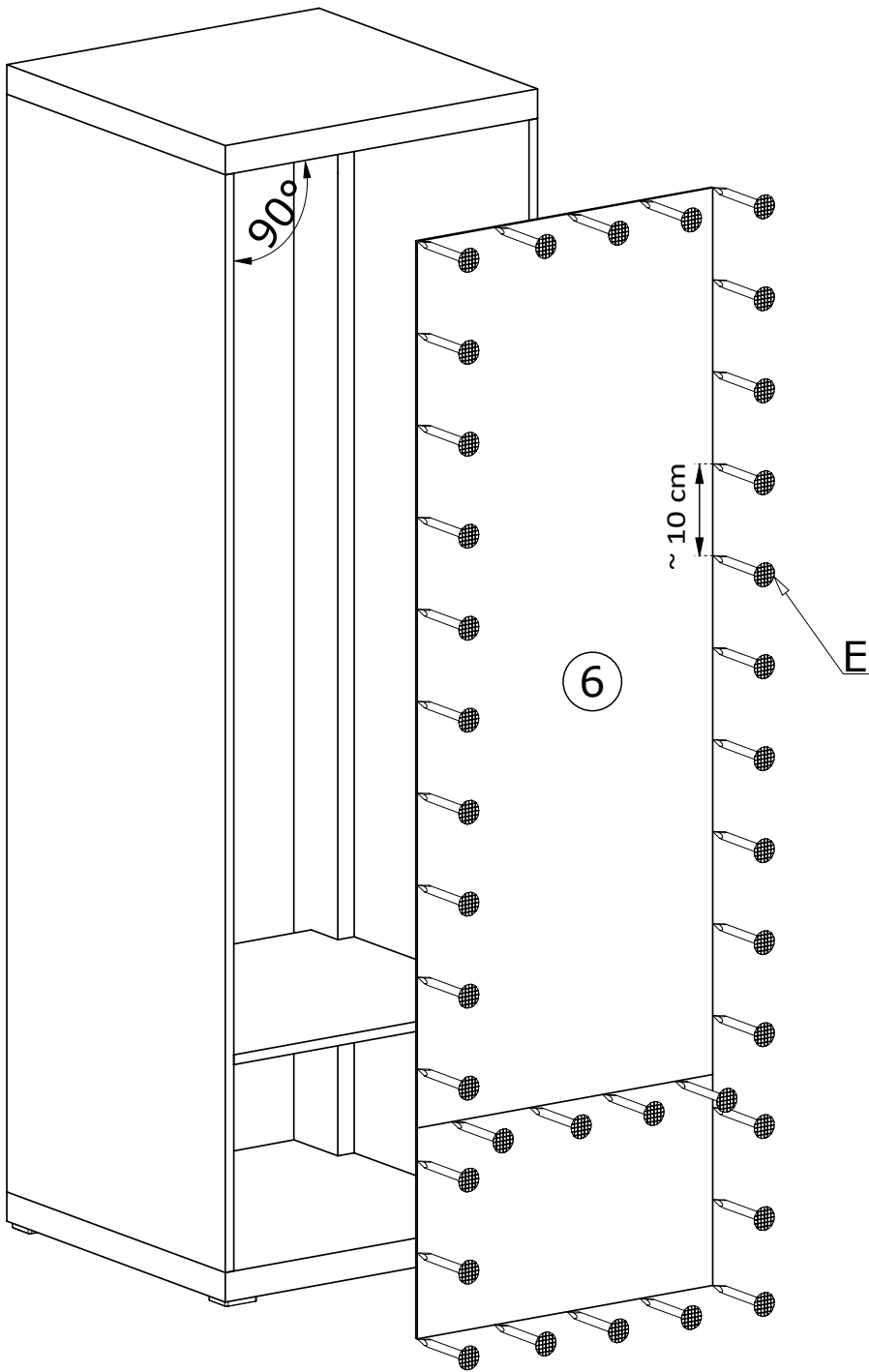

III

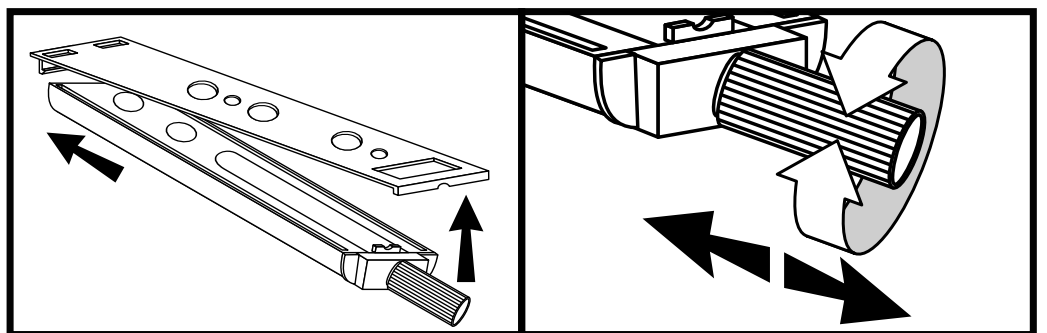
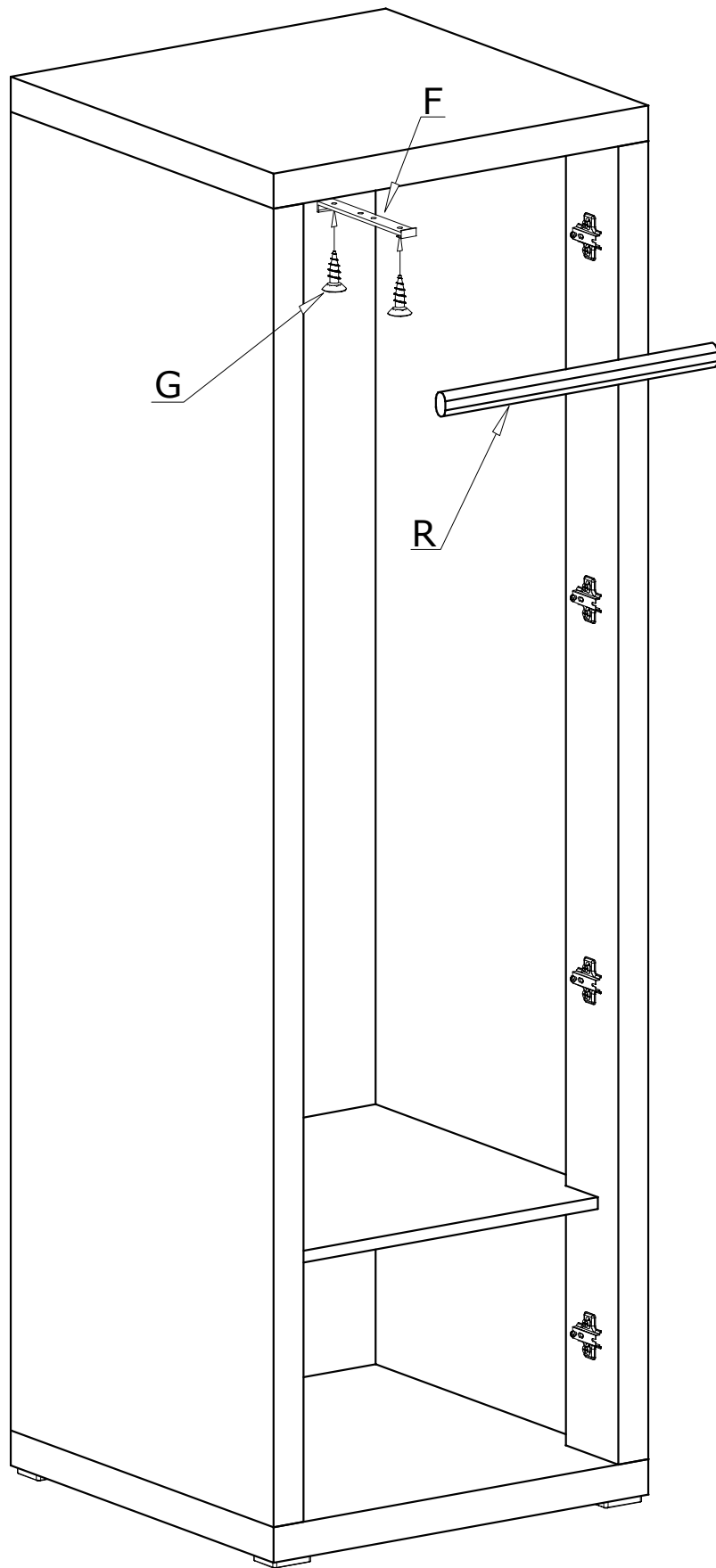

IV

