

# PARIS 1

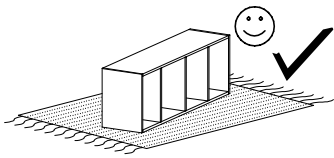

Narzędzia potrzebne do montażu



## UWAGA !!!

MONTOWANIE USZKODZONYCH  
ELEMENTÓW POWODUJE UTRATĘ  
GWARANCJI

Nr	D[mm]	S[mm]	G[mm]	Ilość
1	882	602	48	1
2	882	602	48	1
3	848	553	16	1
4	1790	600	48	1
5	1790	600	48	1
6	1840	872	2,5	1
7	1783	388	16	1
8	1783	388	16	1

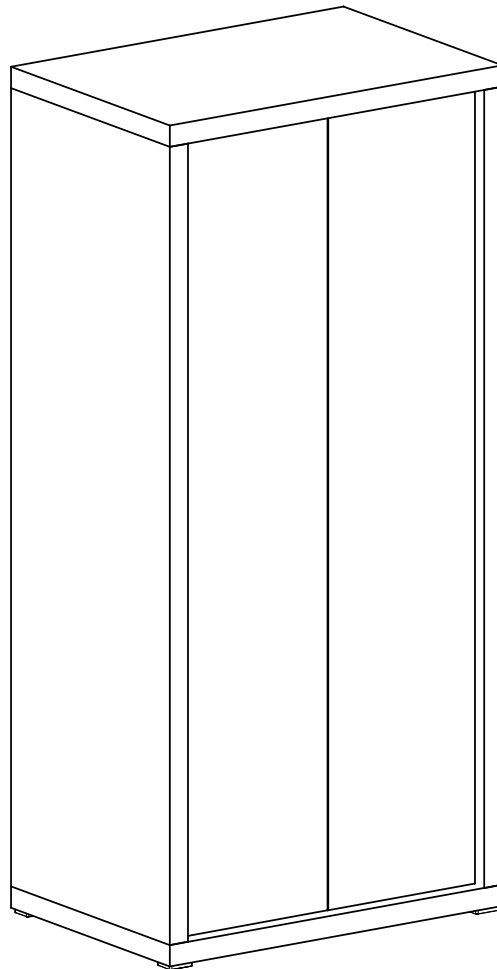

W przypadku reklamacji proszę podać numer pakowacza znajdujący się na kartonie.

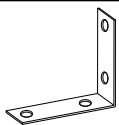

**I - 2 St.**

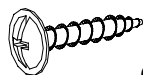

**Q - 4 St.**  
3,5,16 mm



**R - 1 St.**  
840 mm

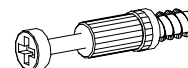

**K - 16 St.**



**G - 24 St.**  
3,5x16 mm



**E - 80 St.**



**M - 8 St.**  
3,5x25 mm

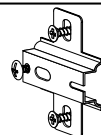

**C - 8 St.**

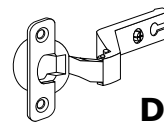

**D - 8 St.**

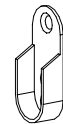

**Y - 2 St.**

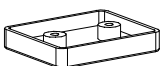

**A - 4 St.**



**B - 16 St.**



**L - 16 St.**

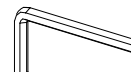

**Z - 1 St.**

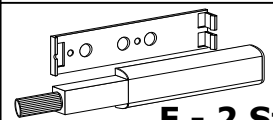

**F - 2 St.**

I

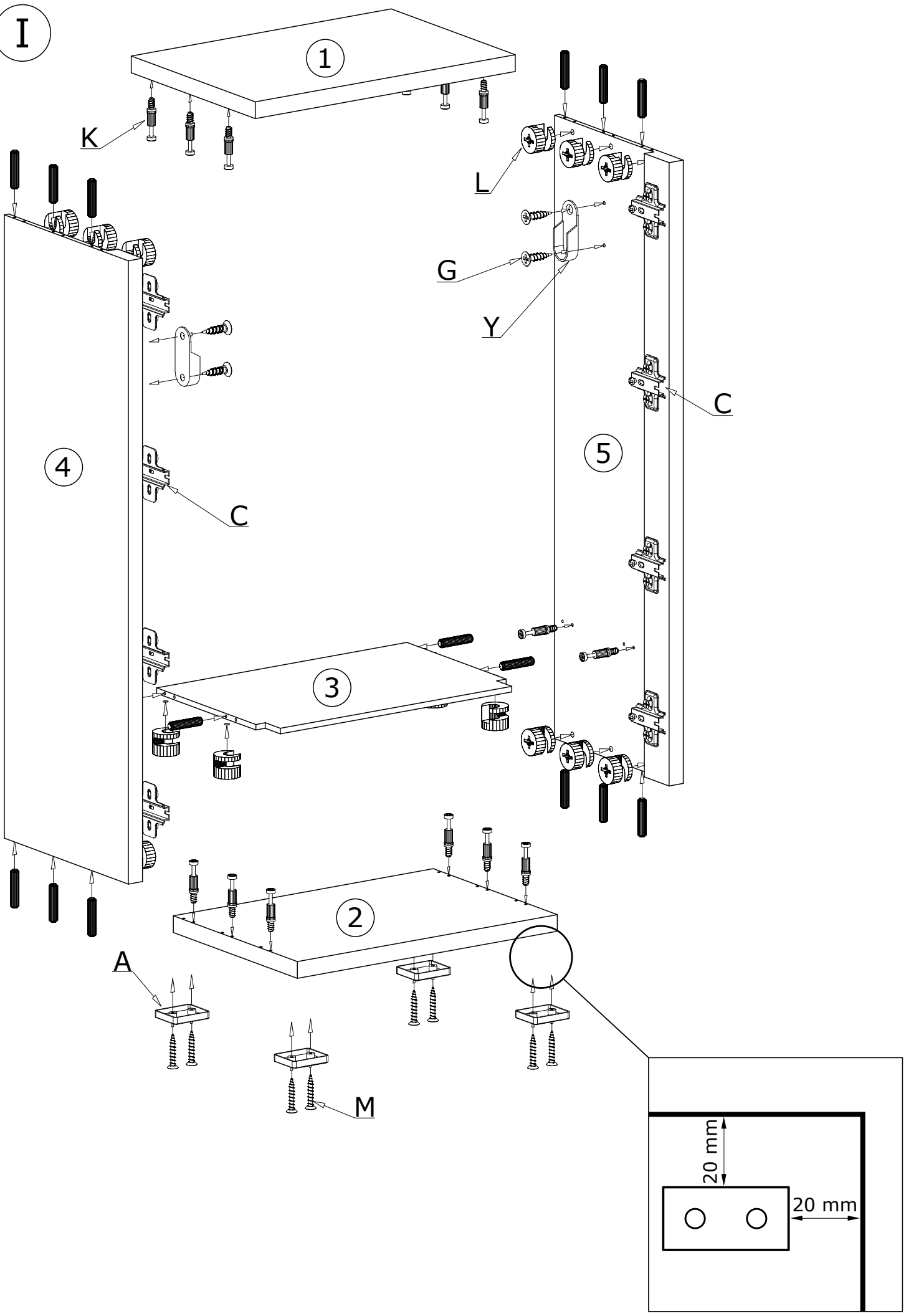

II

80X 

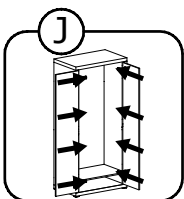
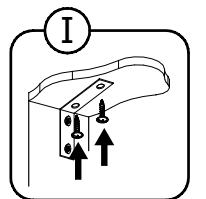
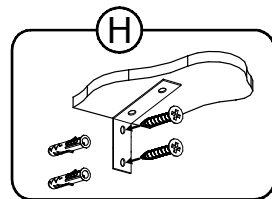
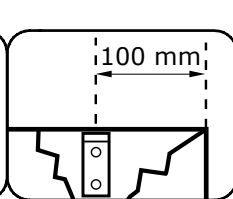
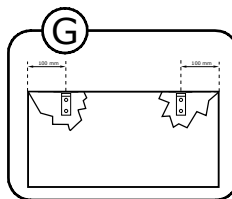
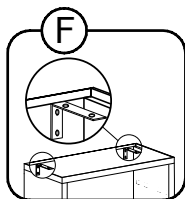
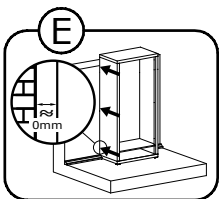
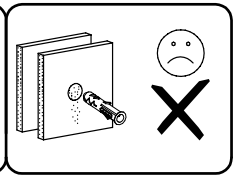
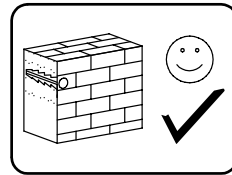
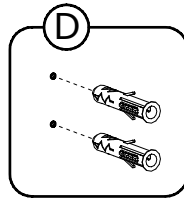
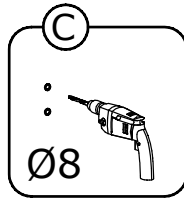
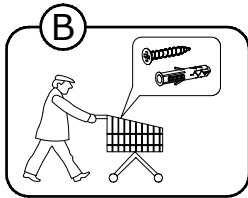
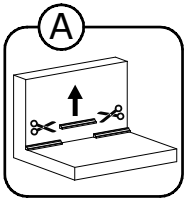
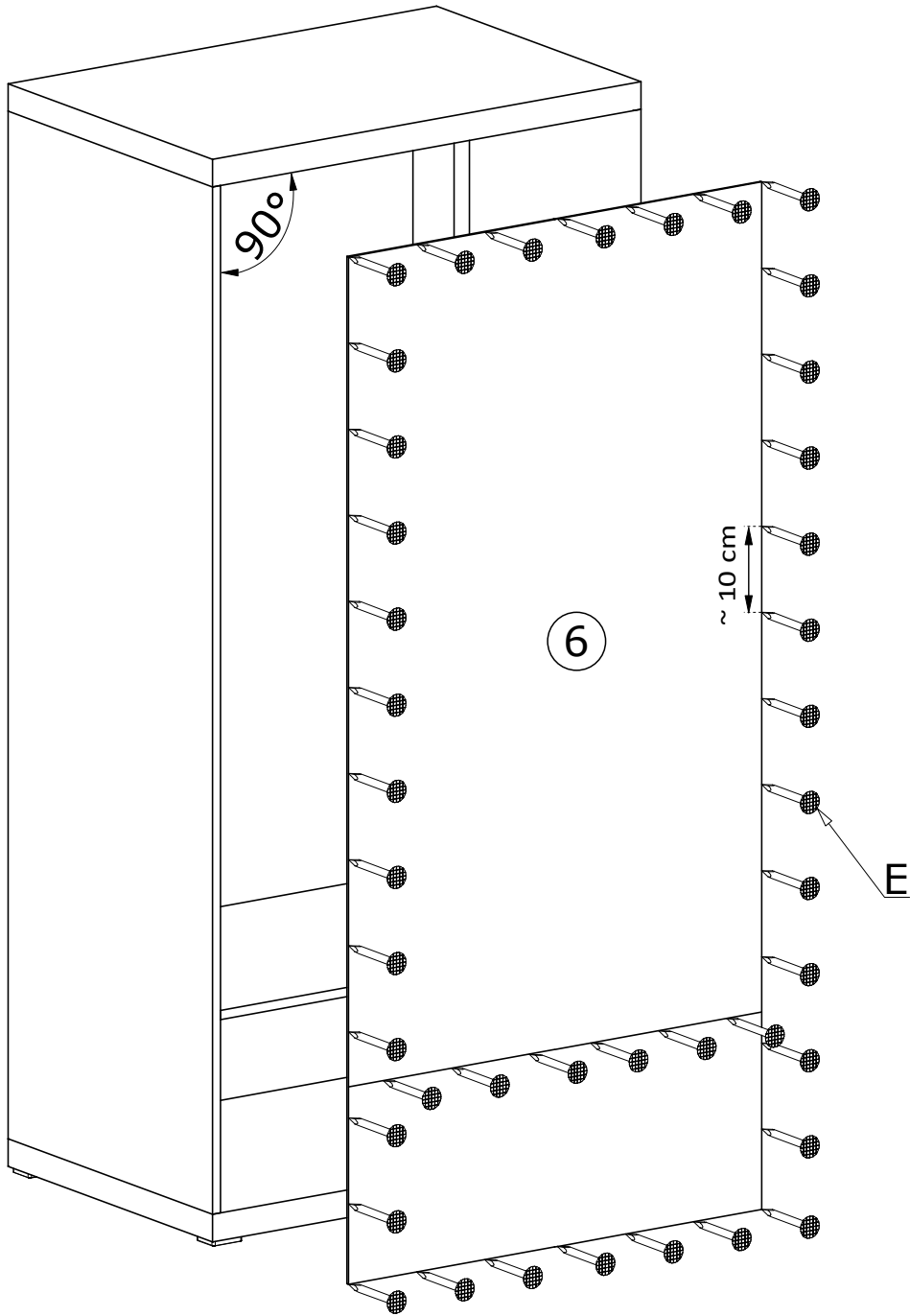

III

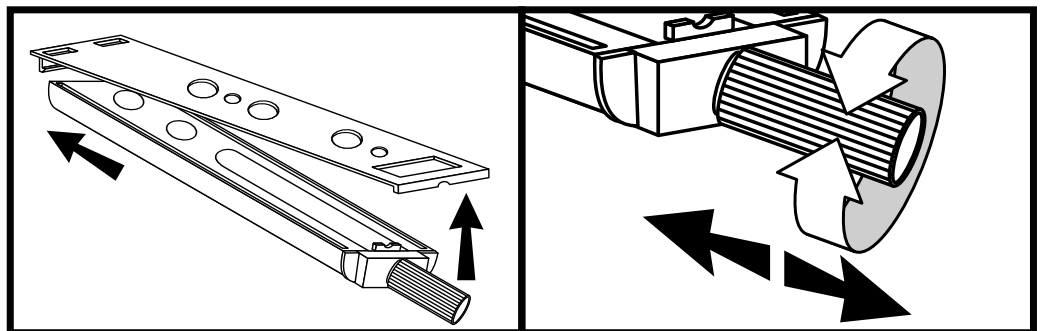
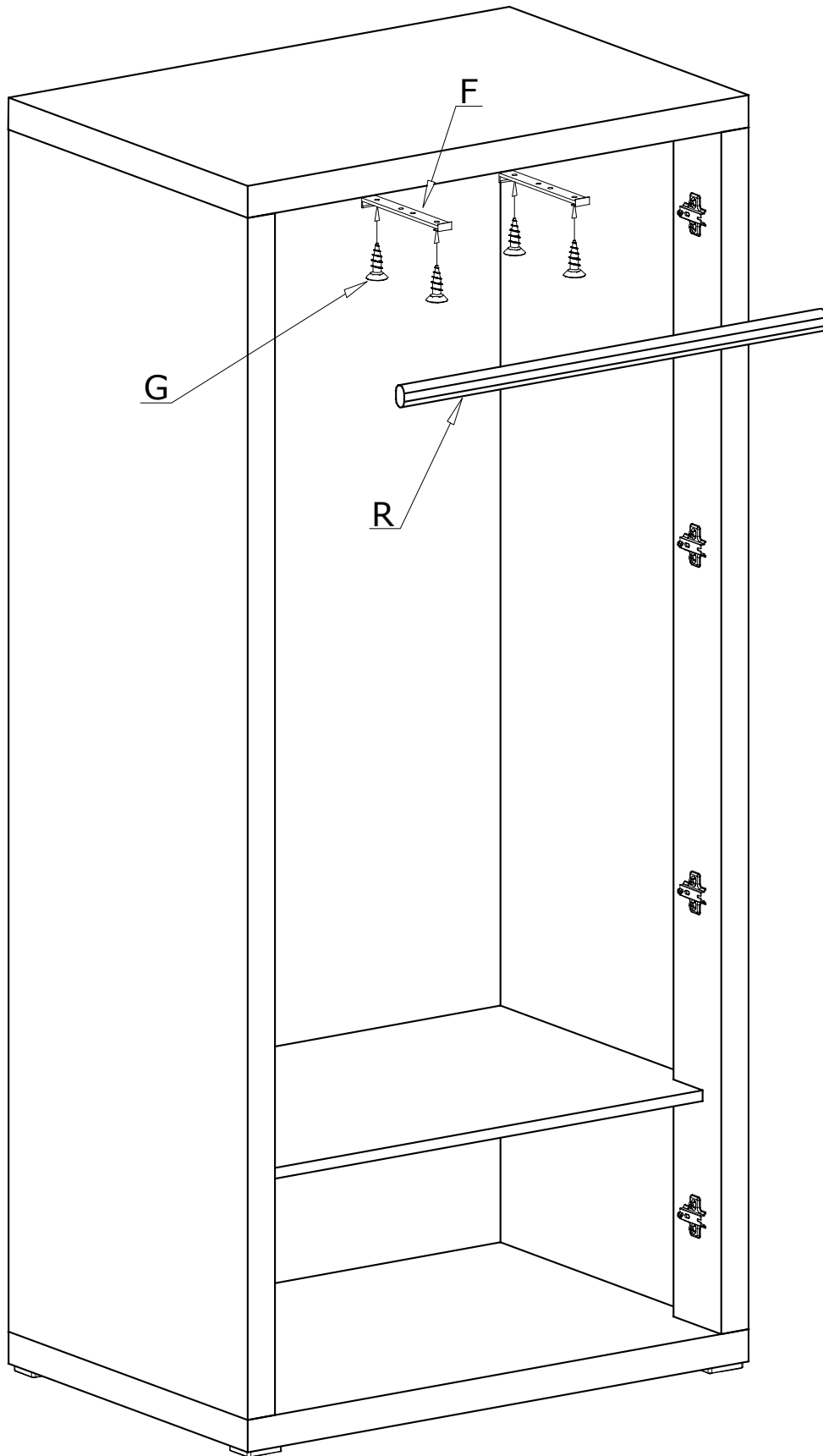

IV

