

# NATURAL 3

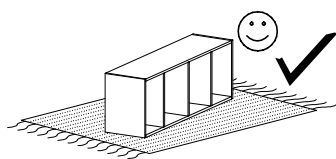

Narzędzia potrzebne do montażu



## UWAGA !!!

MONTOWANIE USZKODZONYCH  
ELEMENTÓW POWODUJE UTRATĘ  
GWARANCJI

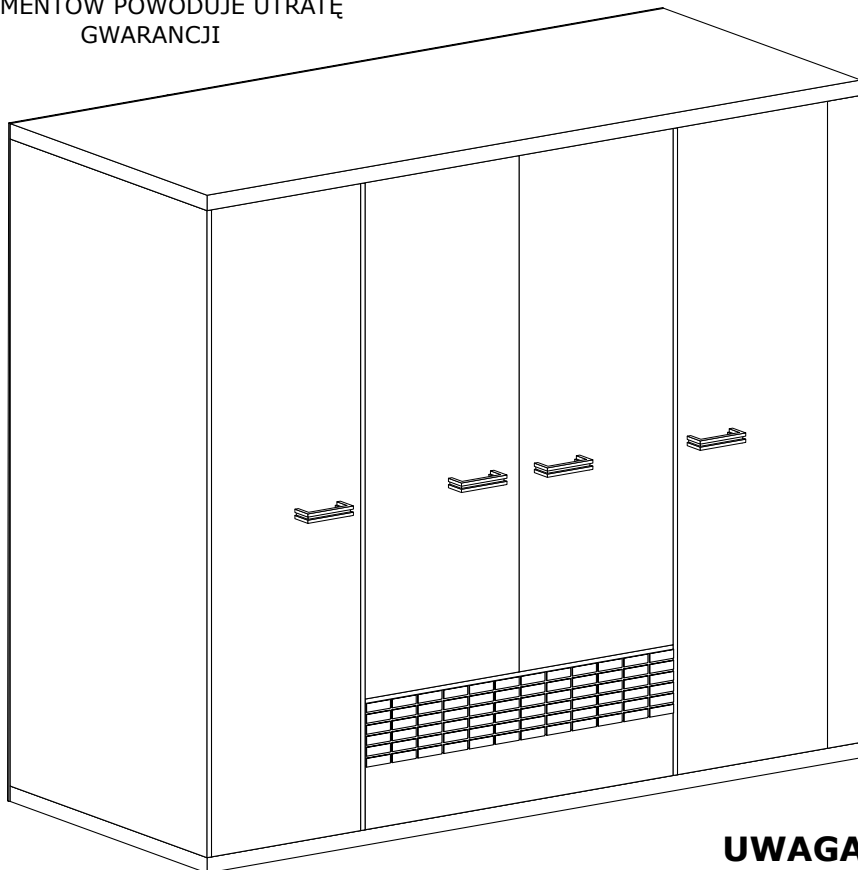

Nr	D[mm]	S[mm]	G[mm]	Ilość
1	1900	576	16	1
2	1900	560	16	1
3	1955	577	48	1
4	1955	577	48	1
5	1900	576	16	2
6	900	560	16	1
7	900	576	16	1
8	1900	100	16	1
9	560	536	16	2
10	560	450	16	2
11	1950	472	2,5	1
12	1950	912	2,5	1
13	1950	555	2,5	1
14	500	165	16	4
15	842	165	16	2
16	892	190	35	1
17	892	190	32	1
18	870	495	2,5	2
19	1894	445	16	2
20	1480	445	16	2

## UWAGA !!!

Mebel zawiera elementy drewniane

W przypadku reklamacji proszę podać numer pakowacza znajdujący się na kartonie.



**X2 - 8 St.**



**A - 4 St.**

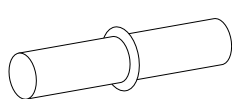

**B - 16 St.**

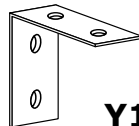

**Y1 - 1 St.**

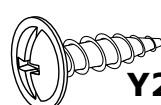

**Y2 - 2 St.**  
3,5x16 mm



**X1 - 21 St.**

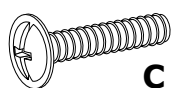

**C - 8 St.**  
4x22 mm

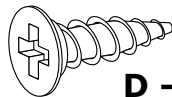

**D - 72 St.**  
3,5x16 mm

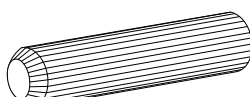

**E - 20 St.**

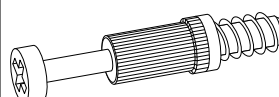

**F - 21 St.**

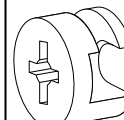

**G - 21 St.**



**H - 16 St.**



**I - 100 St.**

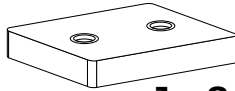

**J - 8 St.**

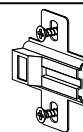

**L - 14 St.**

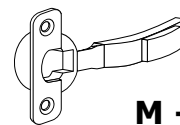

**M - 4 St.**

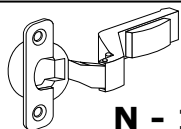

**N - 10 St.**

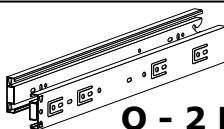

**O - 2 Kpl.**

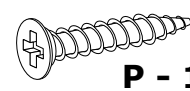

**P - 16 St.**  
3,5x25 mm

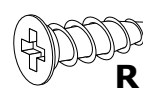

**R - 16 St.**  
5x13 mm

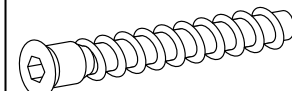

**S - 8 St.**

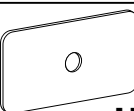

**U - 32 St.**

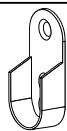

**T - 6 St.**



**W - 75 St.**  
3x30 mm

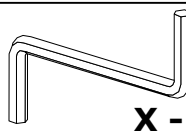

**X - 1 St.**

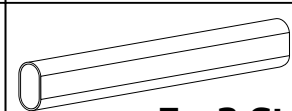

**Z - 3 St.**

I

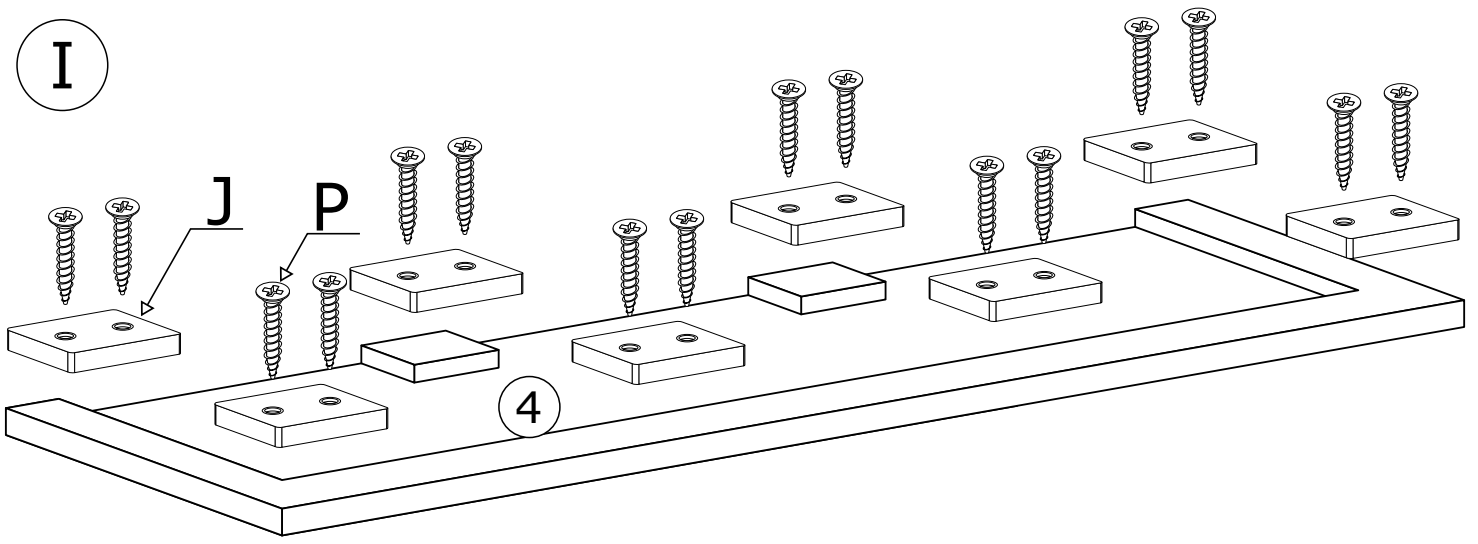

II

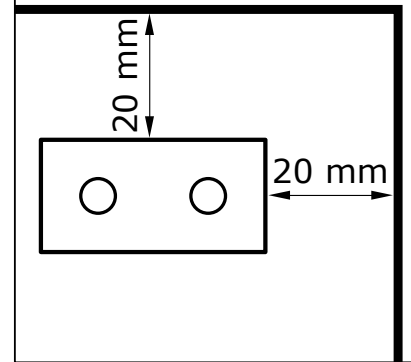
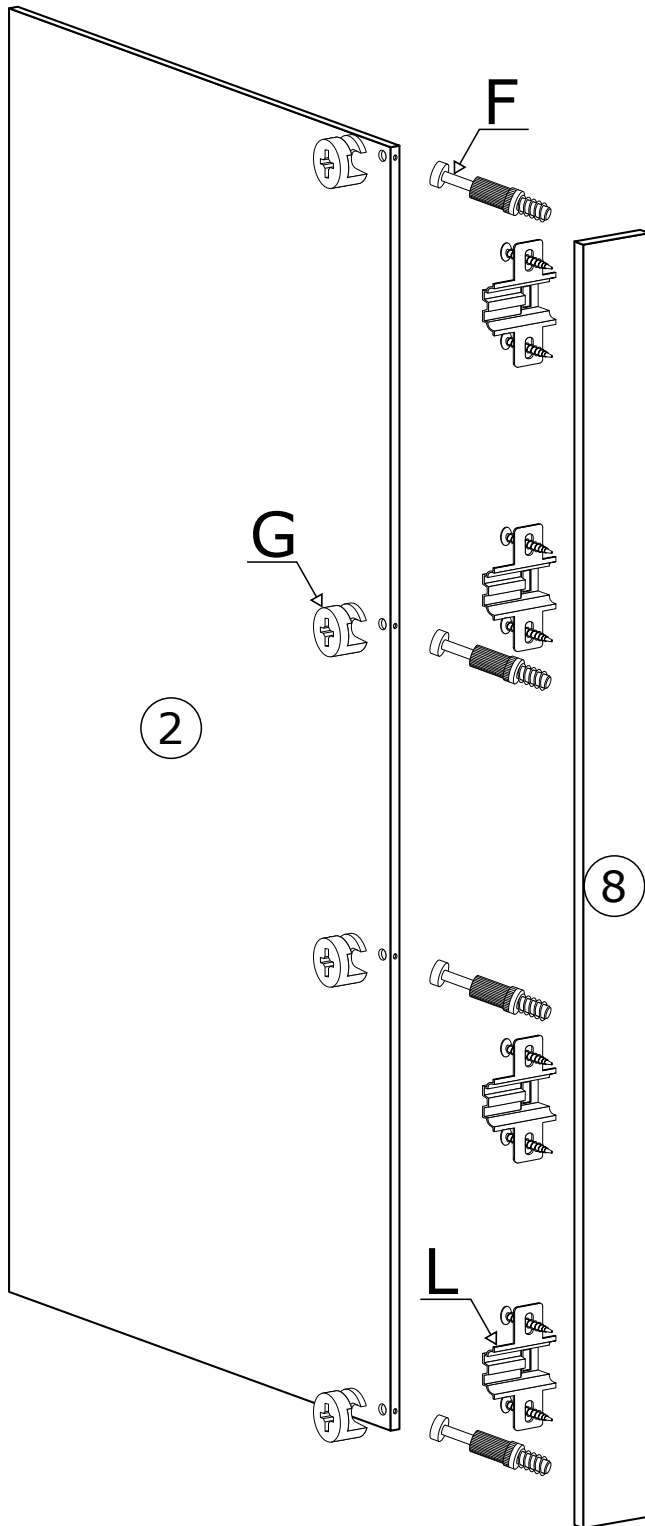

III

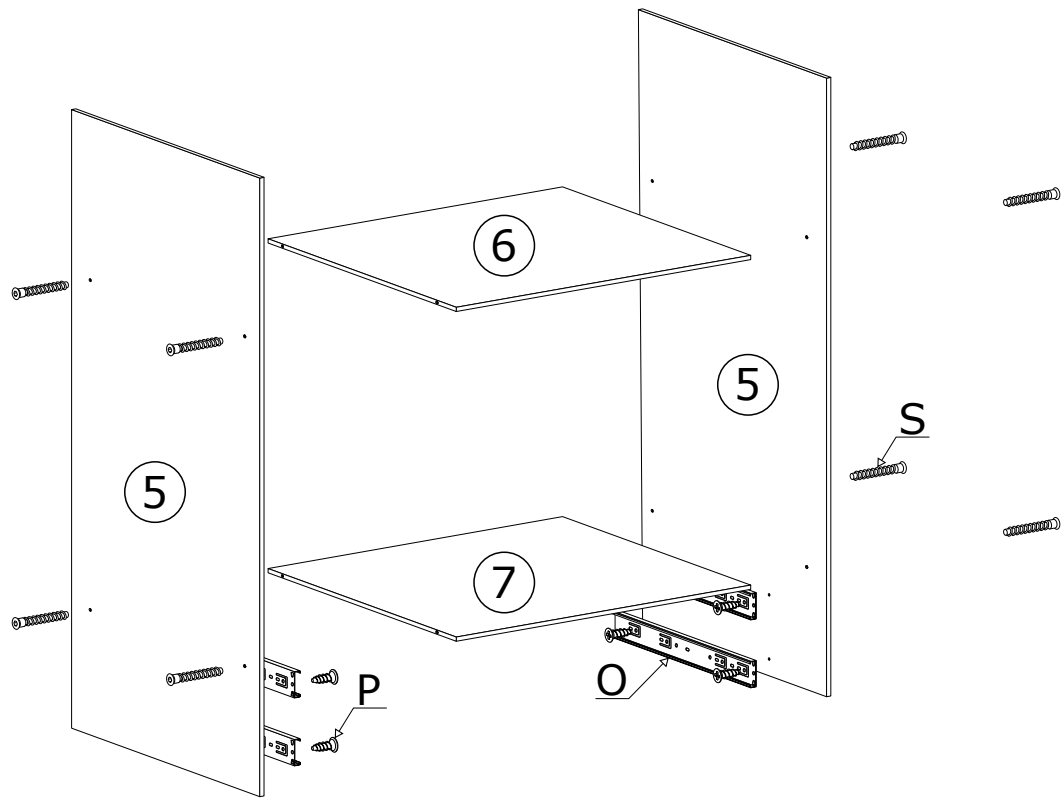

IV

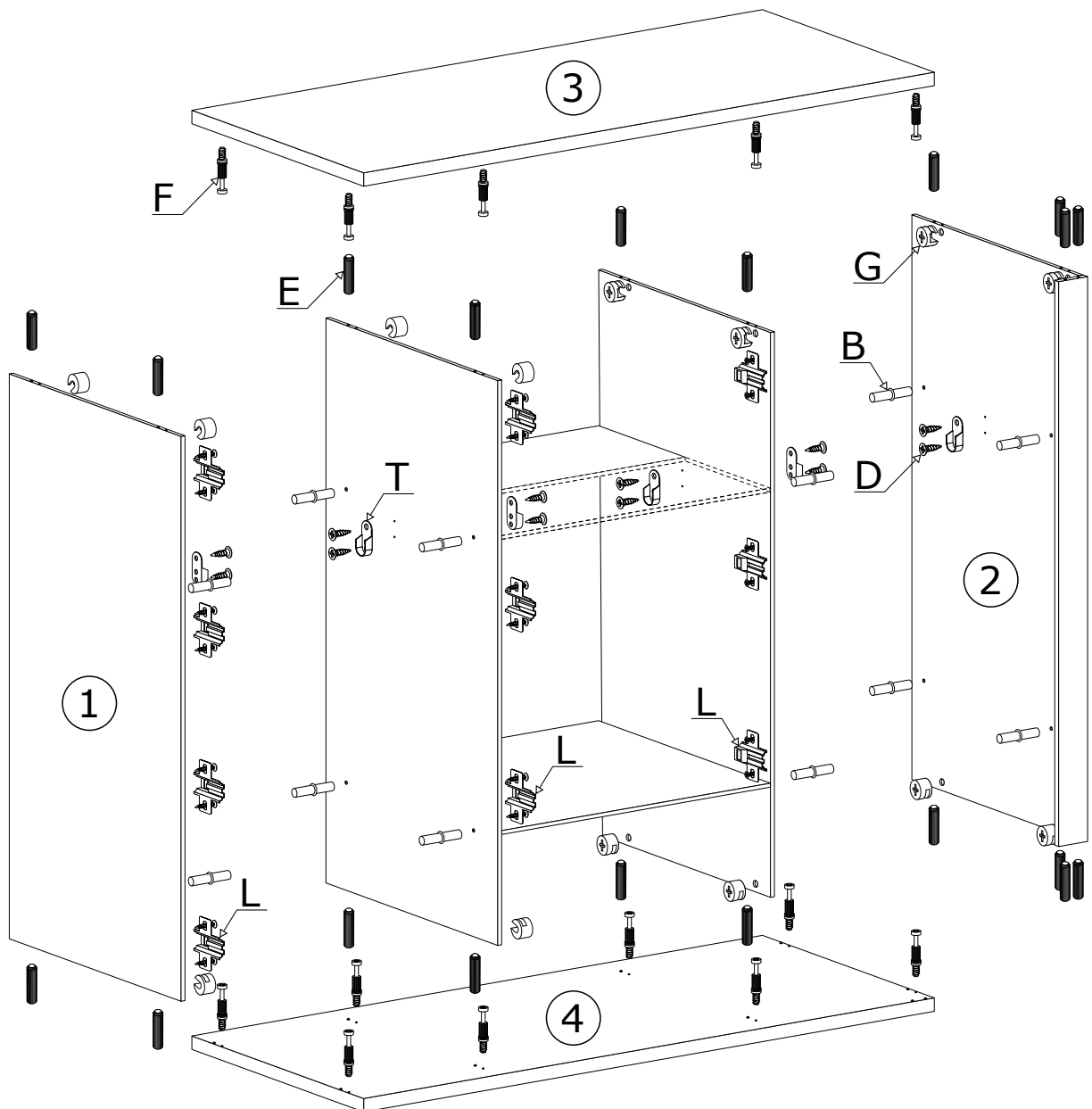

V

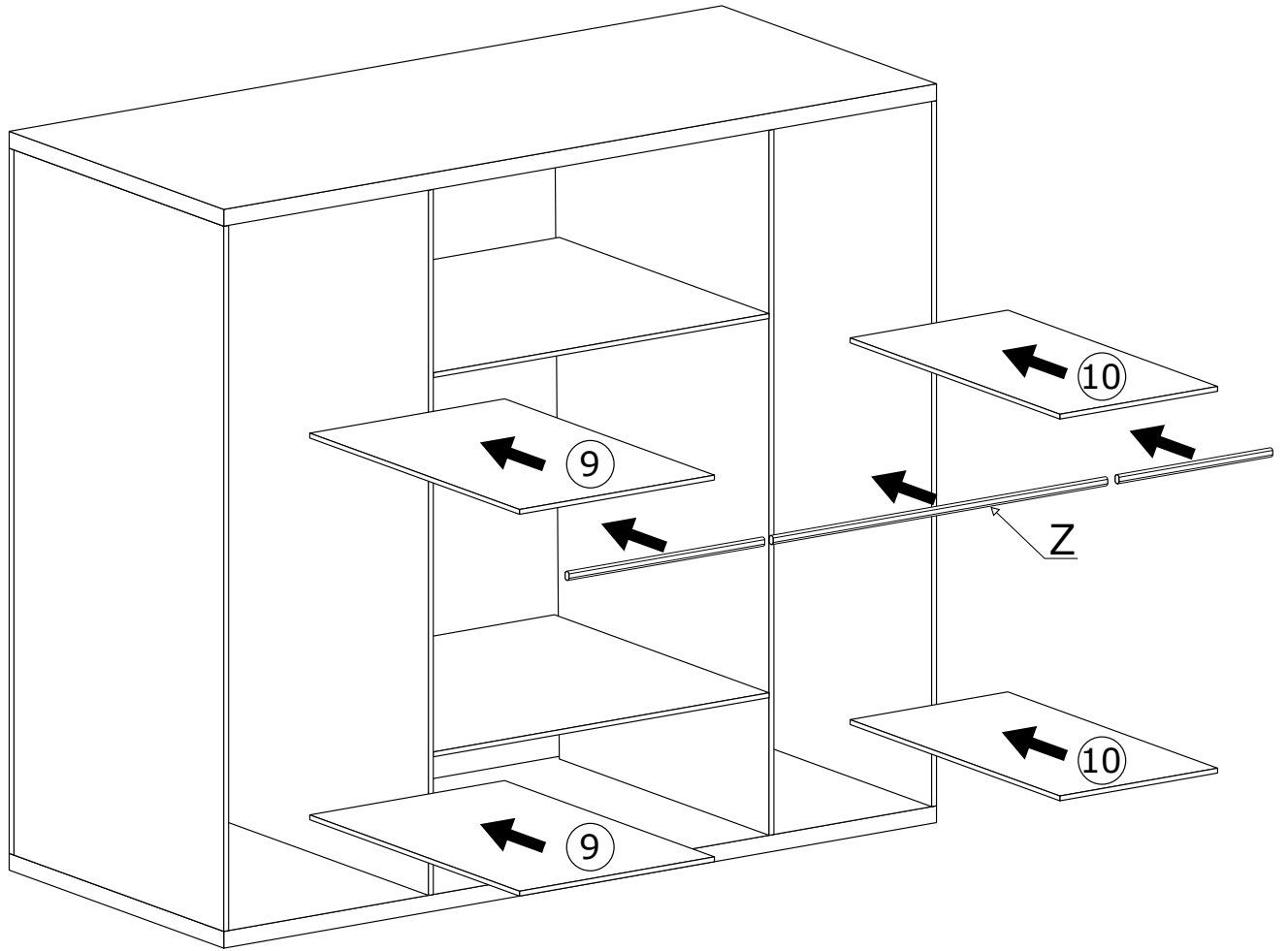

VI

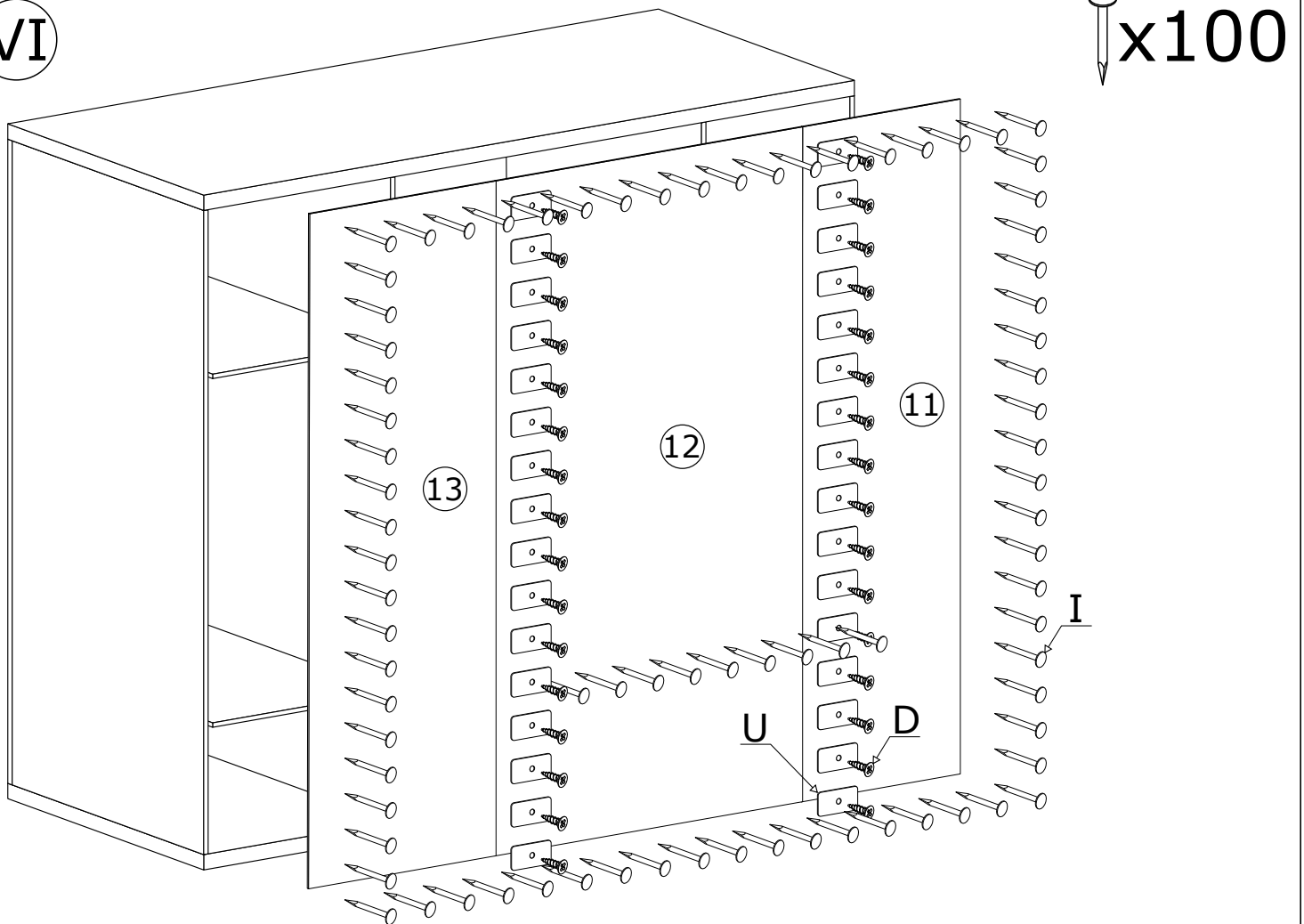

VII

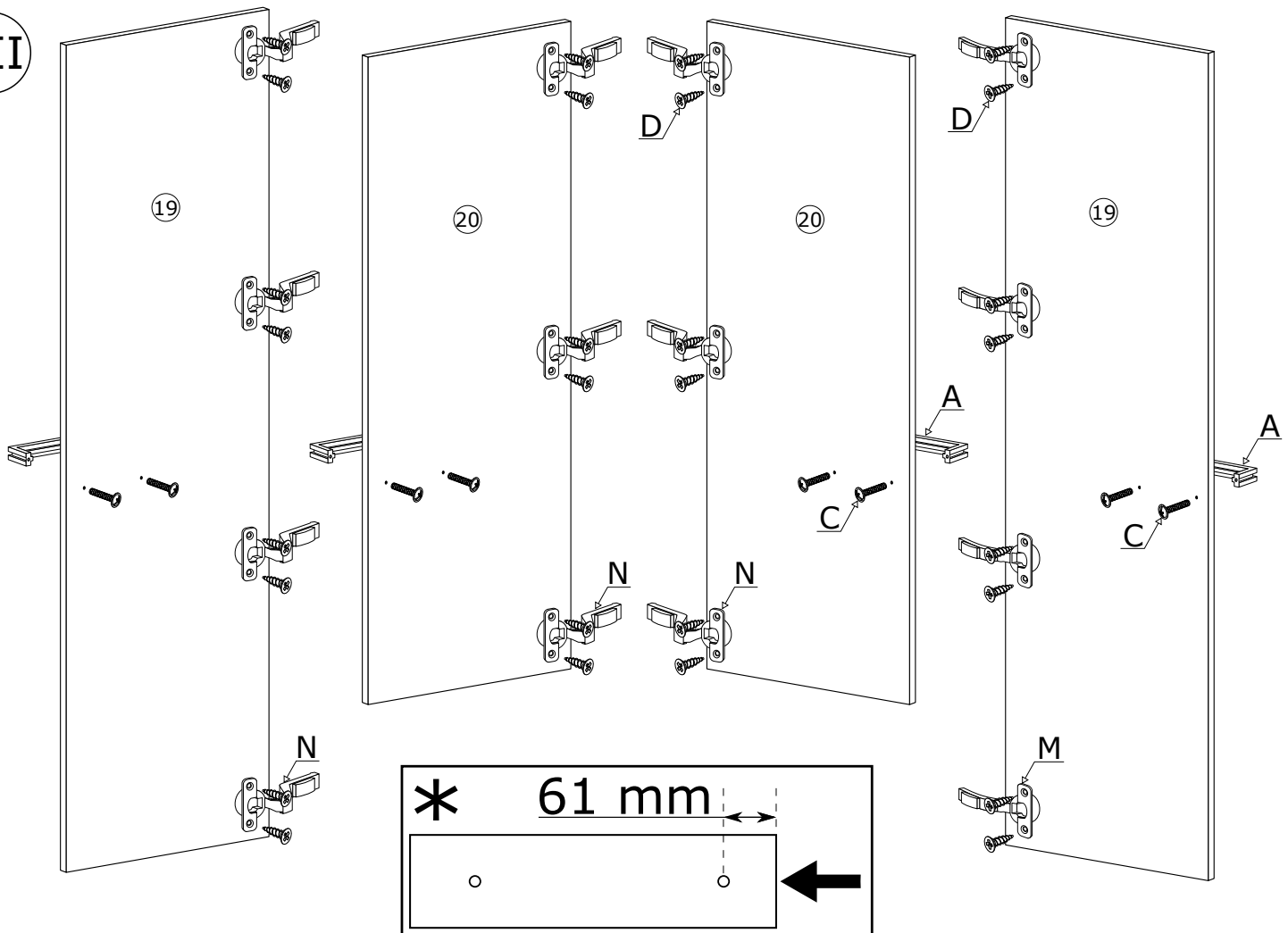

VIII

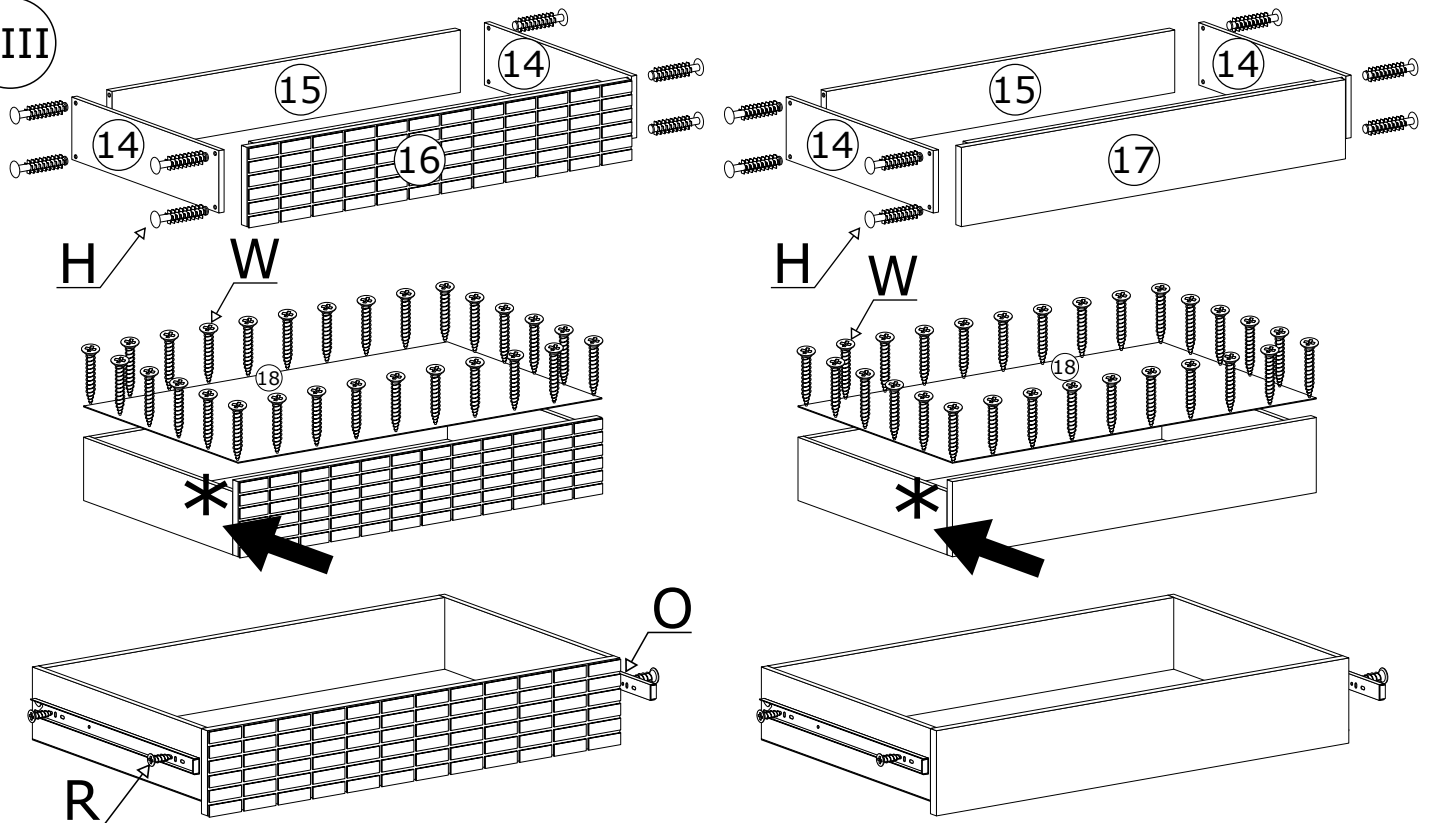

ELEMENT OZDOBNY WYKONANY RĘCZNIE Z PRAWDZIWEGODREWNA.  
 ODCIEŃ DREWNA I OKŁAD SŁOI MOGĄ NIEZNACZNIE ODBIEGAĆ  
 OD PREZENTOWANYCH NA ZDJĘCIACH KATALOGOWYCH.

IX

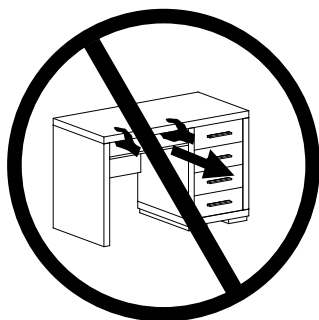
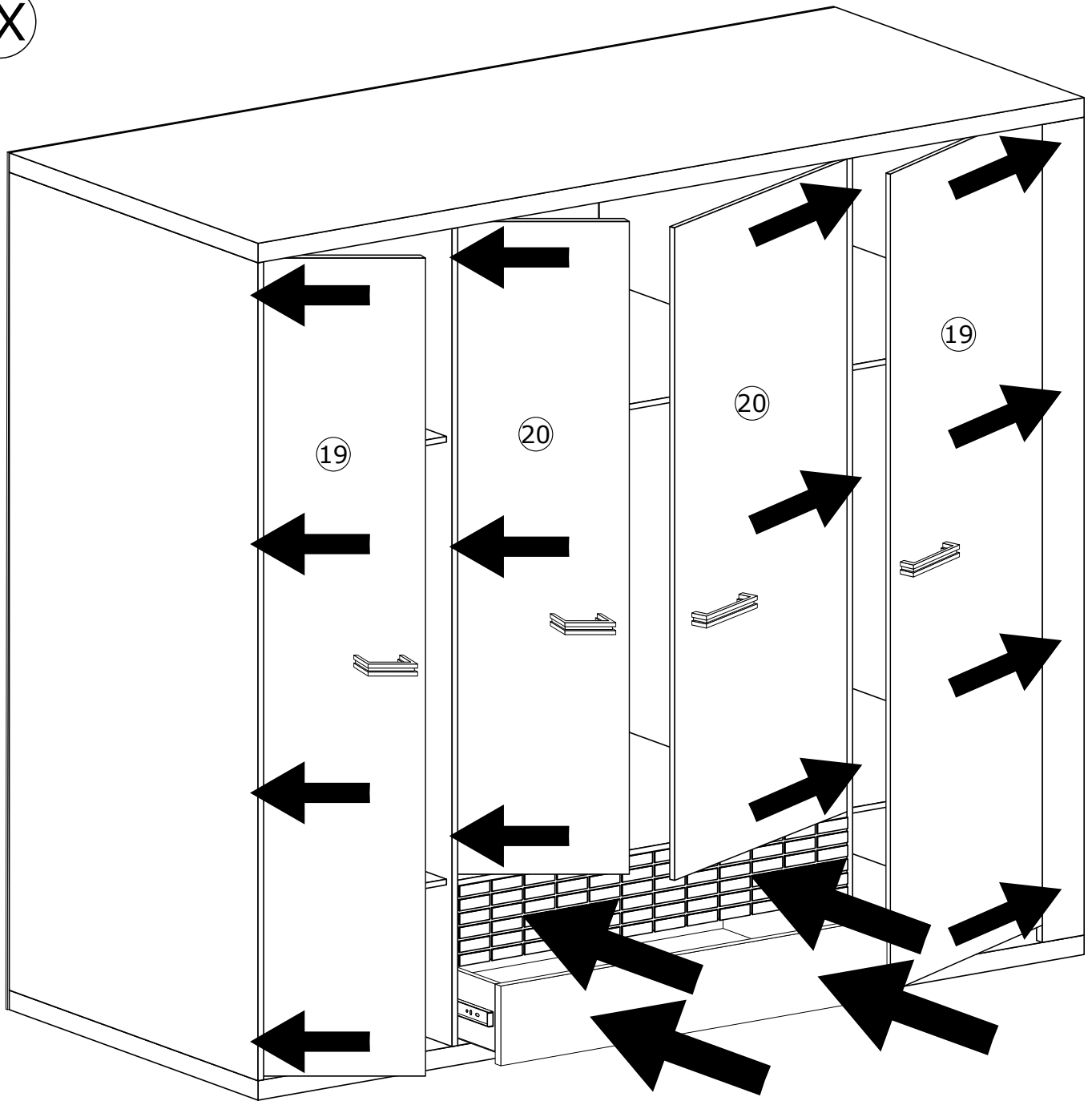

X

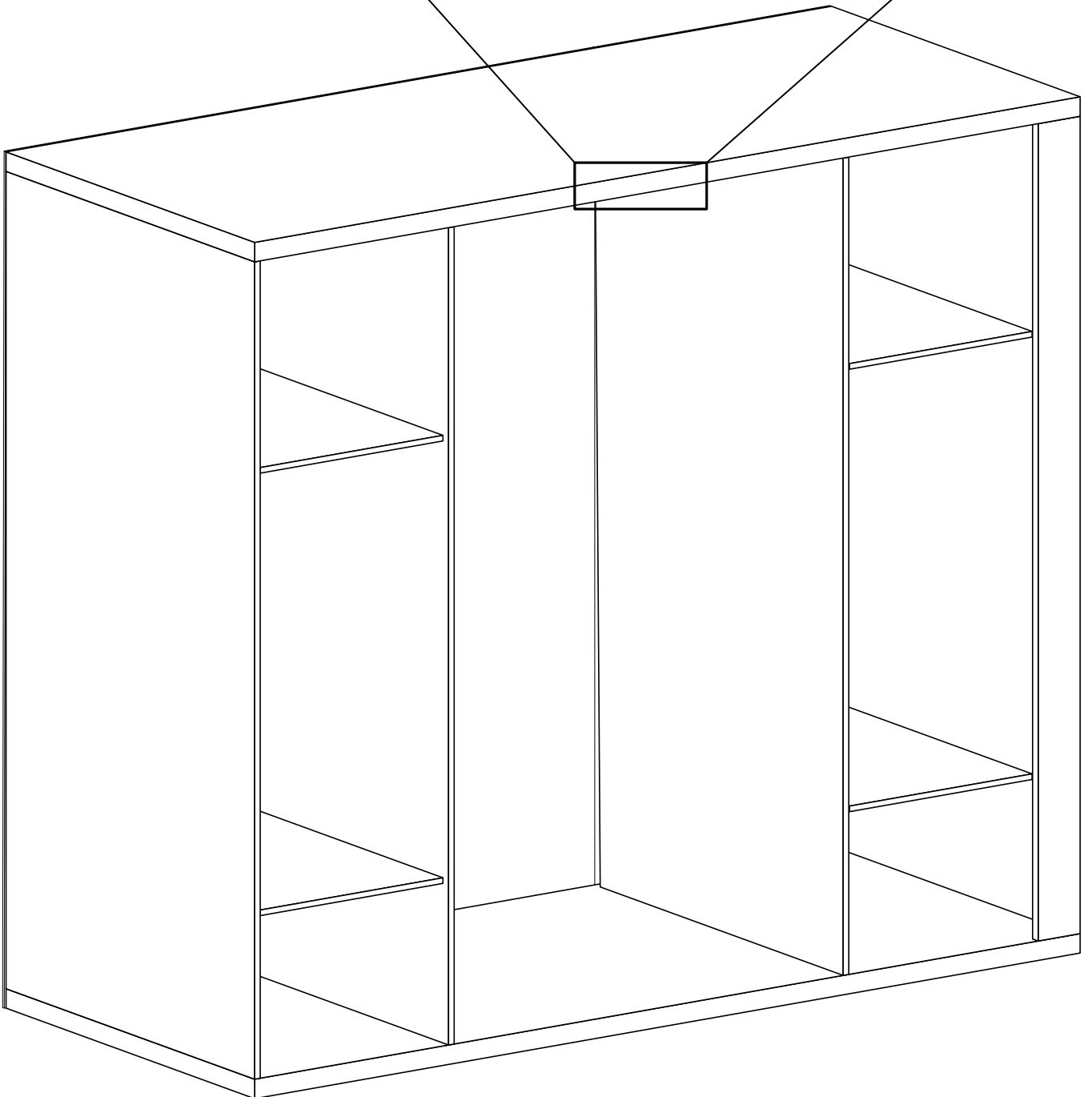
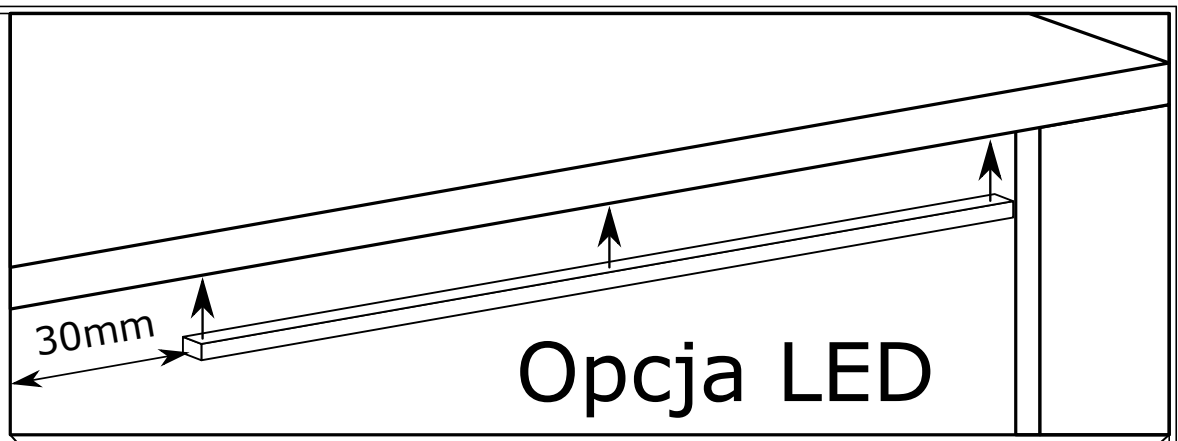

# MONTAŻ/DEMONTAŻ PROWADNIC

1



2



3

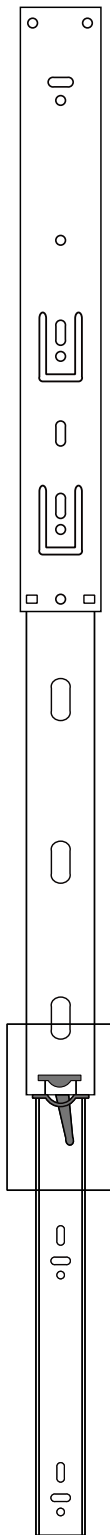

4

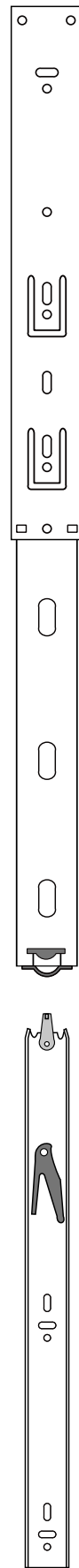



# MONTAŻ KĄTOWNIKA

