

NATURAL 1

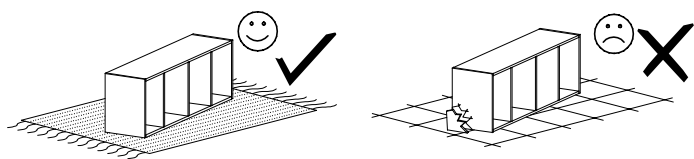

Narzędzia potrzebne do montażu

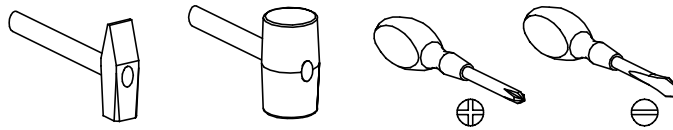

UWAGA !!!

MONTOWANIE USZKODZONYCH
ELEMENTÓW POWODUJE UTRATĘ
GWARANCJI

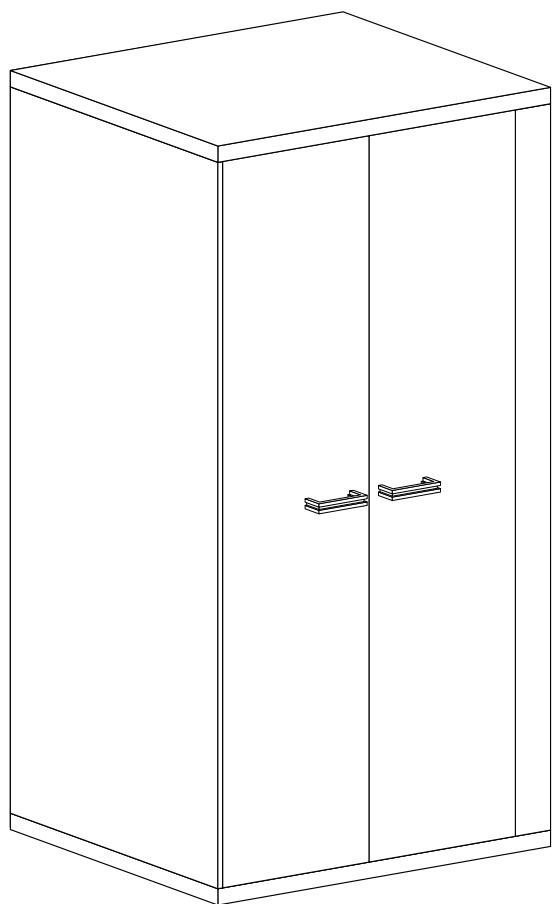

Nr	Nazwa elementu	D[mm]	S[mm]	G[mm]	Ilość
1	Bok Lewy	1900	576	16	1
2	Bok Prawy	1900	560	16	1
3	Blat Górny	1018	577	48	1
4	Blat Dolny	1018	577	48	1
5	Wieniec	983	560	16	1
6	Listwa Pionowa	1900	100	16	1
7	Listwa Tylna	983	120	16	1
8	Kapak	1950	1100	2,5	1
9	Drzwi Lewe	1894	445	16	1
10	Drzwi Prawe	1894	445	16	1

UWAGA !!!

Mebel zawiera
elementy drewniane

W przypadku reklamacji proszę podać numer pakowacza znajdujący się na kartonie.

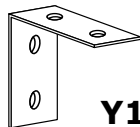

Y1 - 1 St.

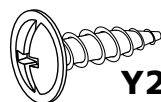

Y2 - 2 St.
3,5x16 mm



X1 - 21 St.



X2 - 4 St.
ø8 mm



X3 - 4 St.
ø5 mm



A - 2 St.

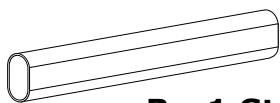

B - 1 St.

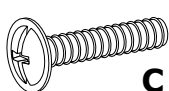

C - 4 St.
4x22 mm

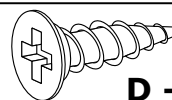

D - 28 St.
3,5x16 mm

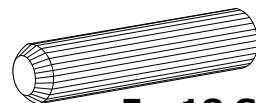

E - 18 St.

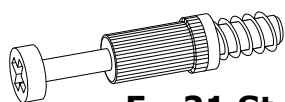

F - 21 St.

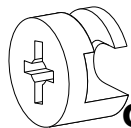

G - 21 St.

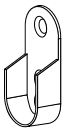

H - 2 St.



I - 80 St.

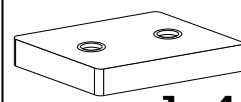

J - 4 St.

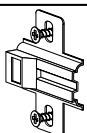

L - 8 St.

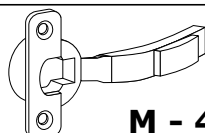

M - 4 St.

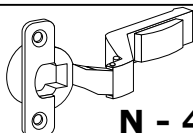

N - 4 St.

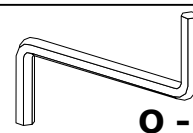

O - 1 St.

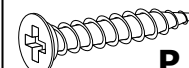

P - 8 St.
3,5x25 mm

I

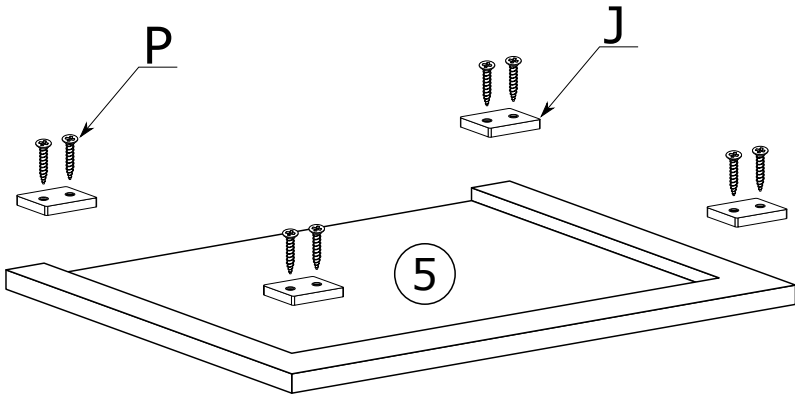

II

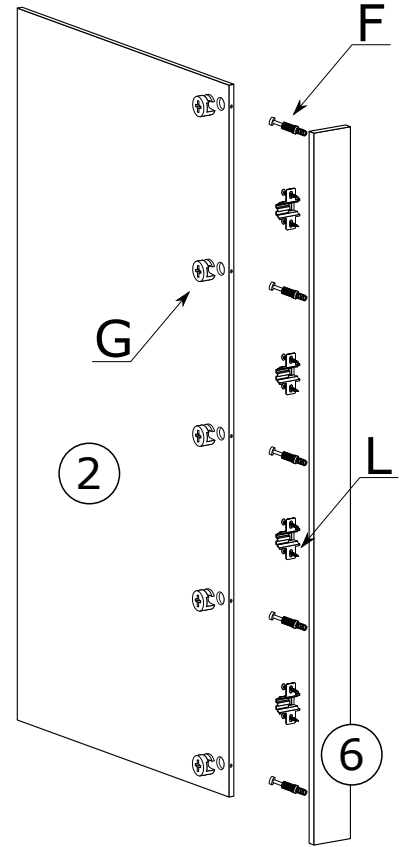

III

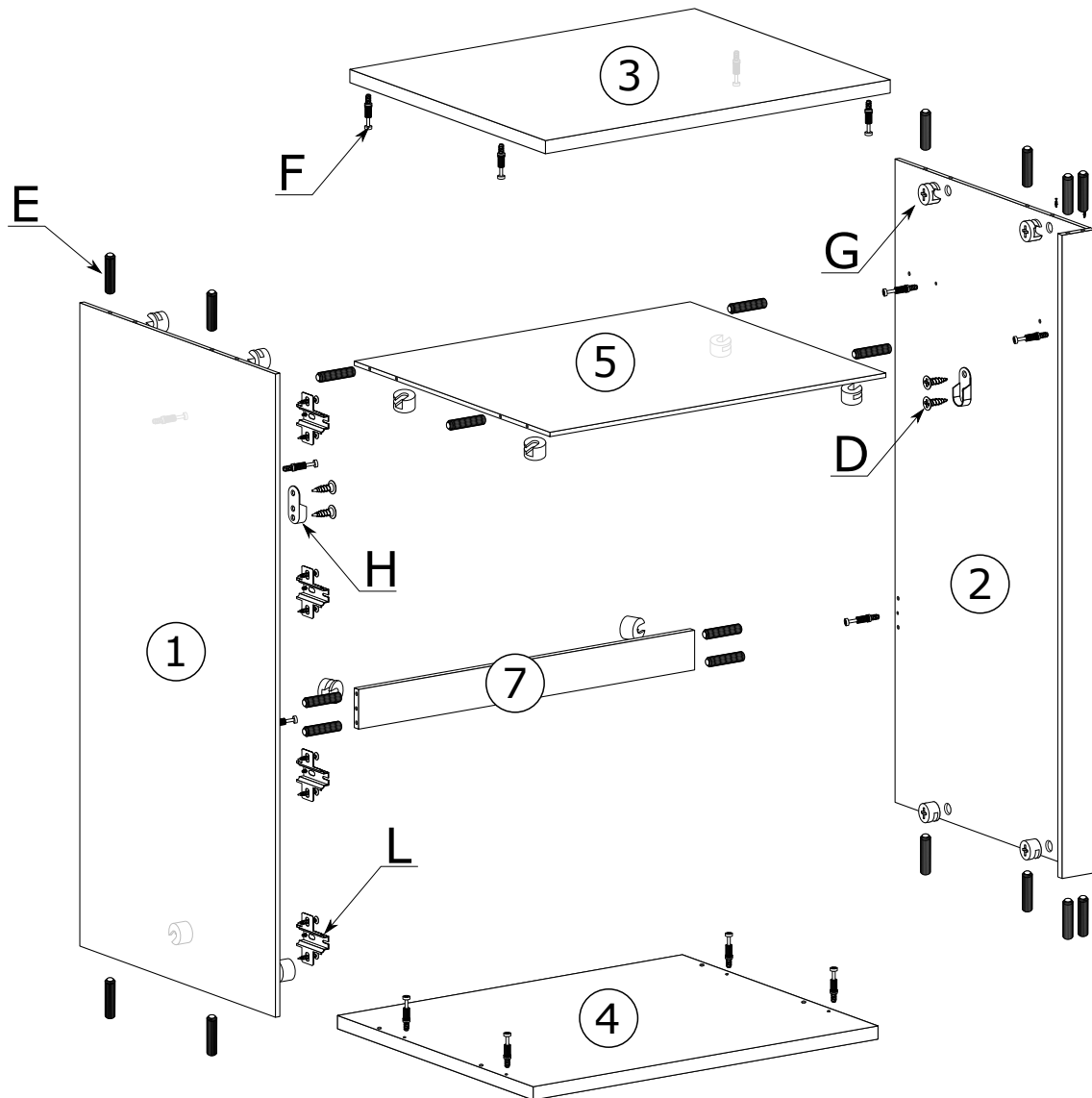

IV

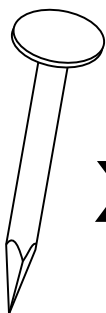
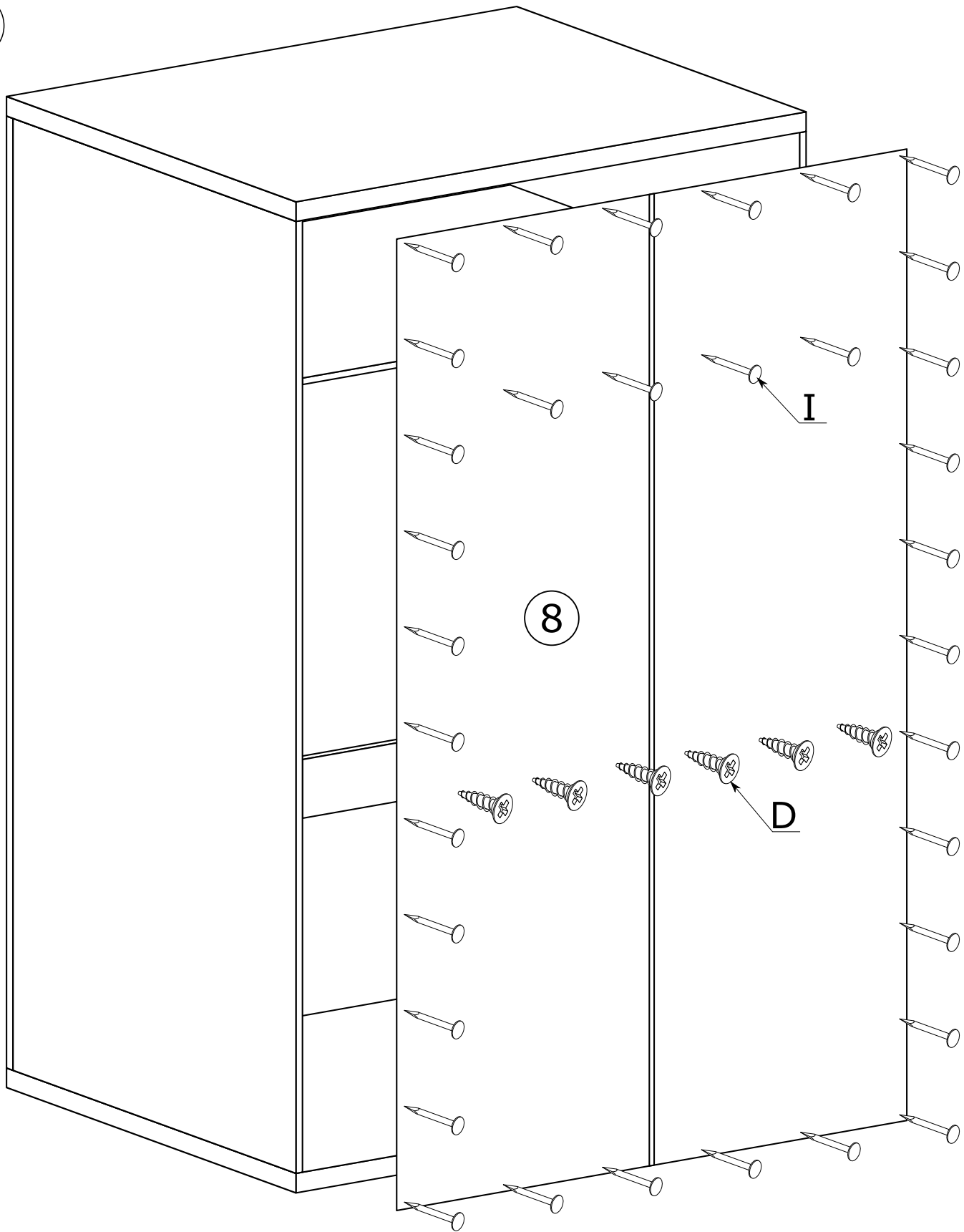

x80

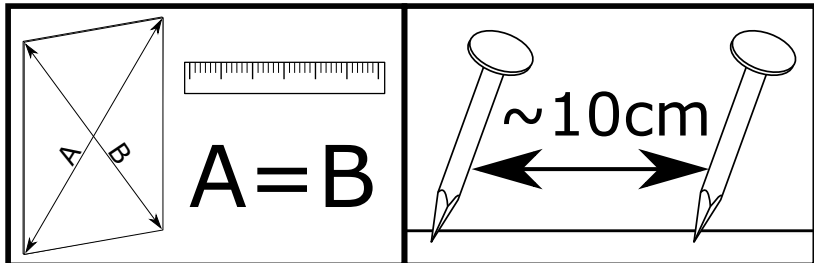

V

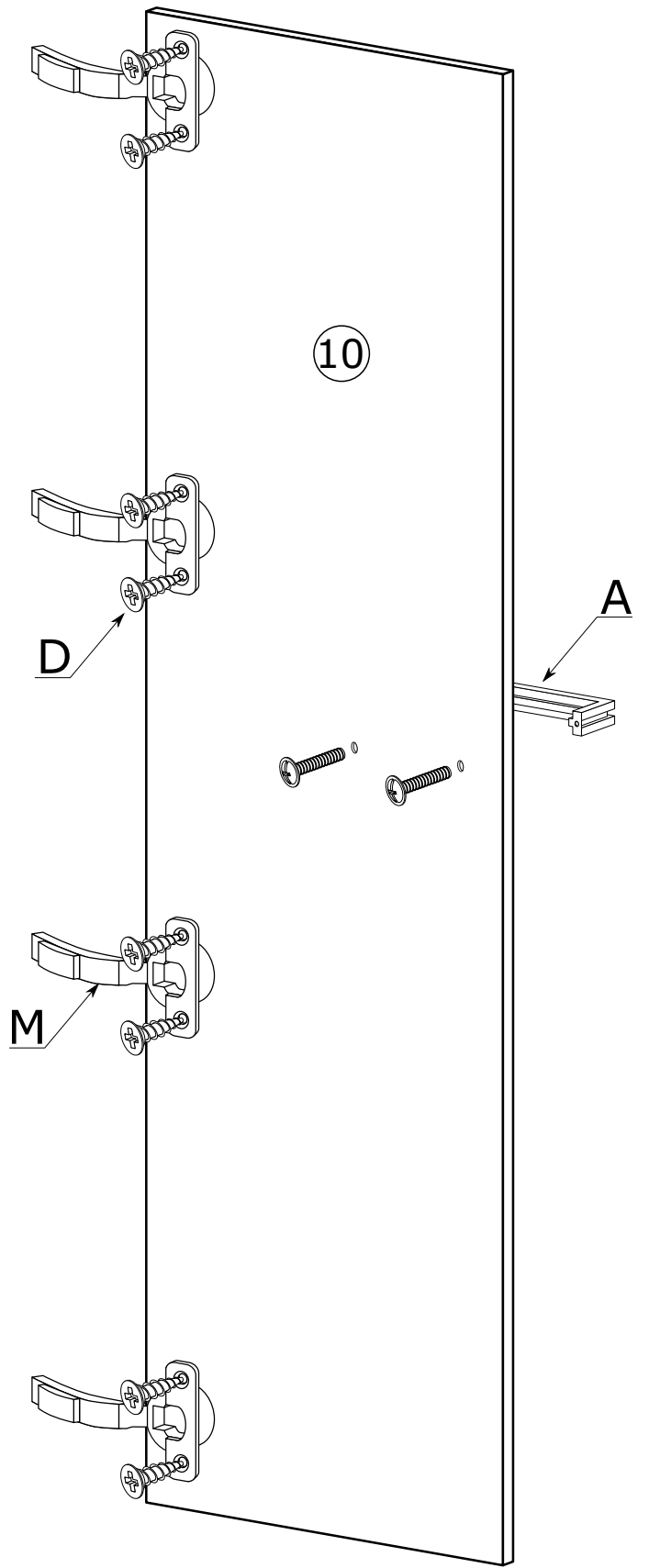
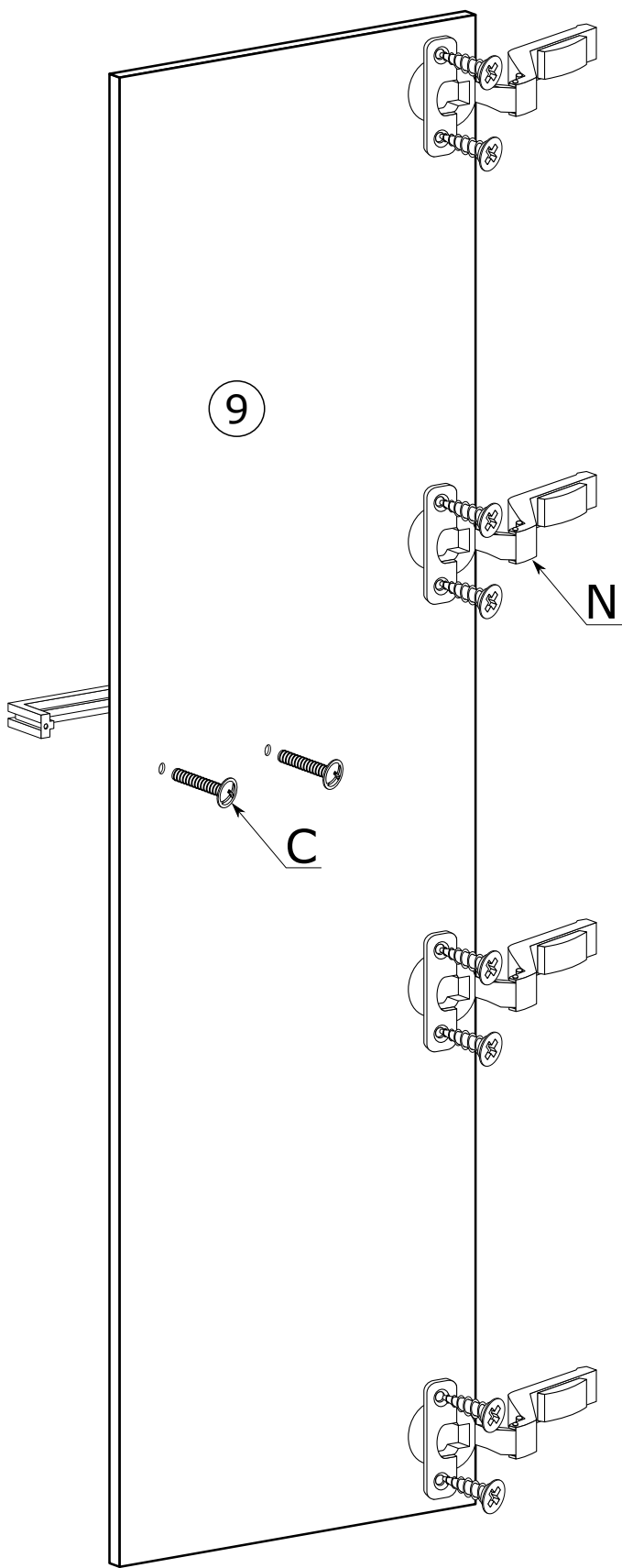

VI

