

# MEDIOLAN 2

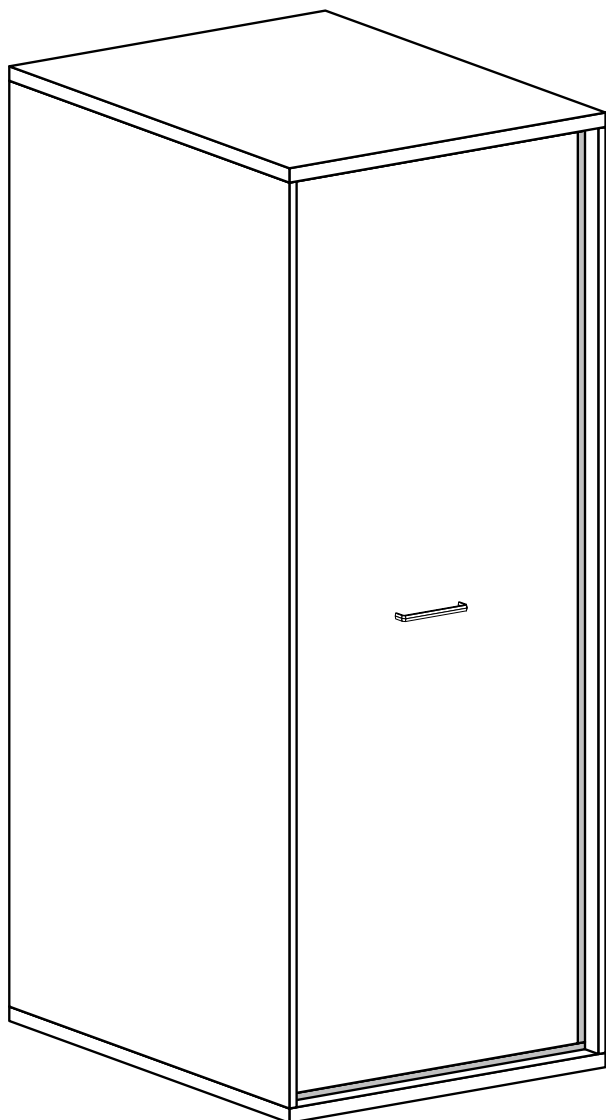

Narzędzia potrzebne do montażu



Nr	Nazwa elementu	D[mm]	S[mm]	G[mm]	Ilość
1	Bok P/L	1897	580	16	2
2	Błat Górny	581	495	32	1
3	Błat Dolny	581	495	32	1
4	Wieniec	542	462	16	1
5	Listwa Czarna	1897	20	16	2
6	Listwa Czarna	429	20	16	2
7	Kapak	1940	490	2,5	1
8	Drzwi	1856	422	16	1

## **UWAGA !!!**

MONTOWANIE USZKODZONYCH  
ELEMENTÓW POWODUJE UTRATĘ  
GWARANCJI

## **UWAGA !!!**

Mebel zawiera  
elementy drewniane

W przypadku reklamacji proszę podać numer pakowacza znajdujący się na kartonie.



**A - 1 St.**

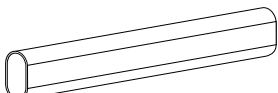

**B - 1 St.**

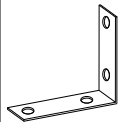

**Y1 - 1 St.**

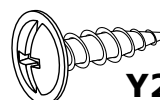

**Y2 - 2 St.**  
3,5x16 mm

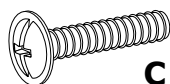

**C - 2 St.**  
4x22 mm

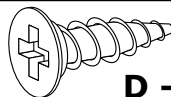

**D - 20 St.**  
3,5x16 mm

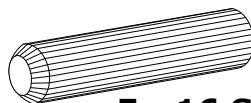

**E - 16 St.**

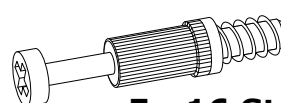

**F - 16 St.**

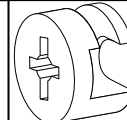

**G - 16 St.**

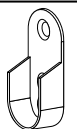

**H - 2 St.**



**I - 50 St.**

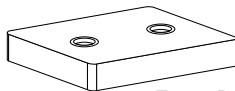

**J - 4 St.**

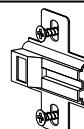

**L - 4 St.**

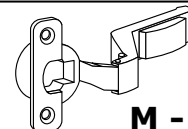

**M - 4 St.**

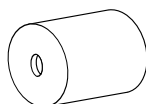

**N - 8 St.**



**O - 1 St.**

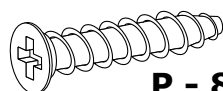

**P - 8 St.**  
6,3x30 mm



**X1 - 16 St.**



**Z - 1 St.**

I L

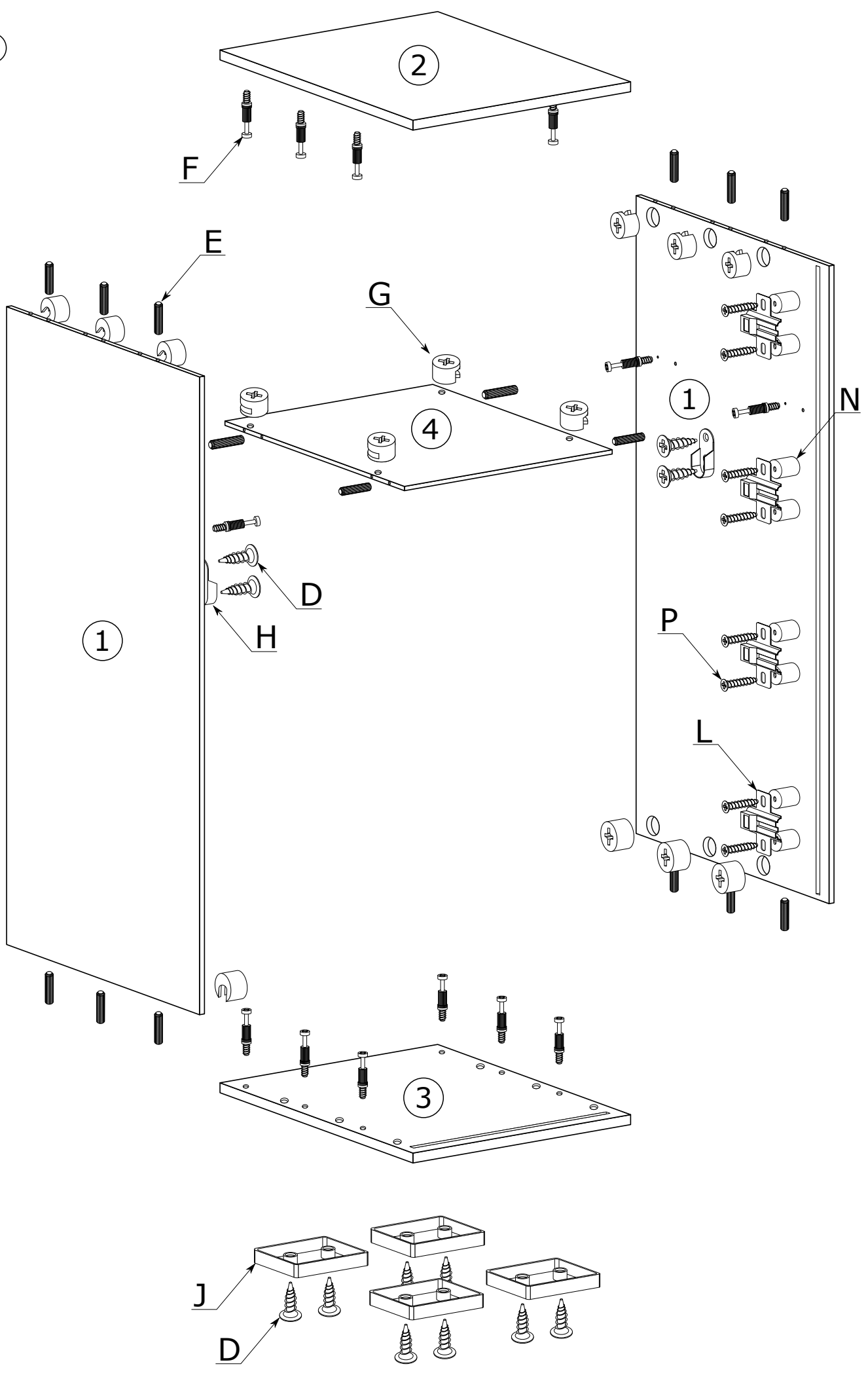

I P

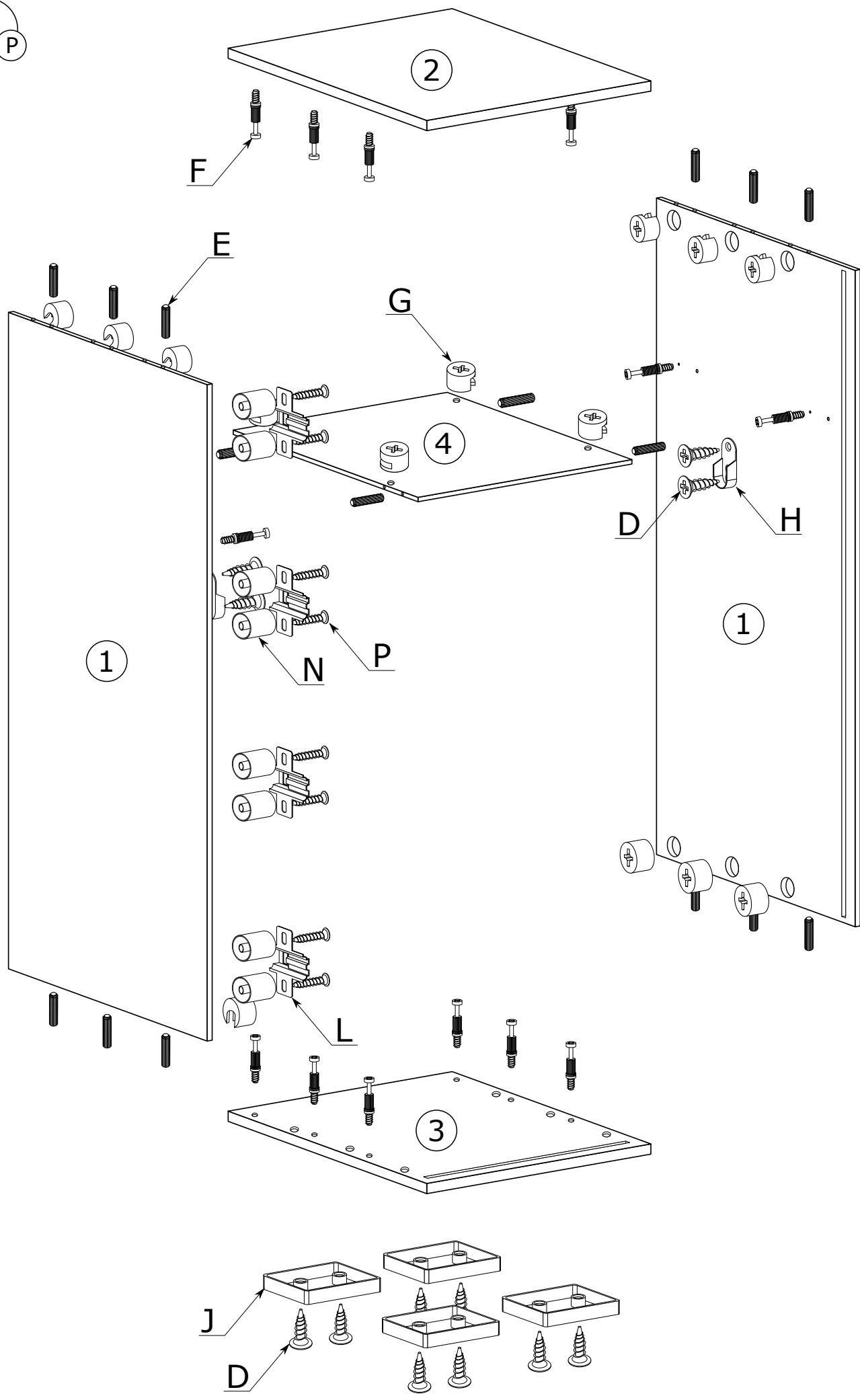

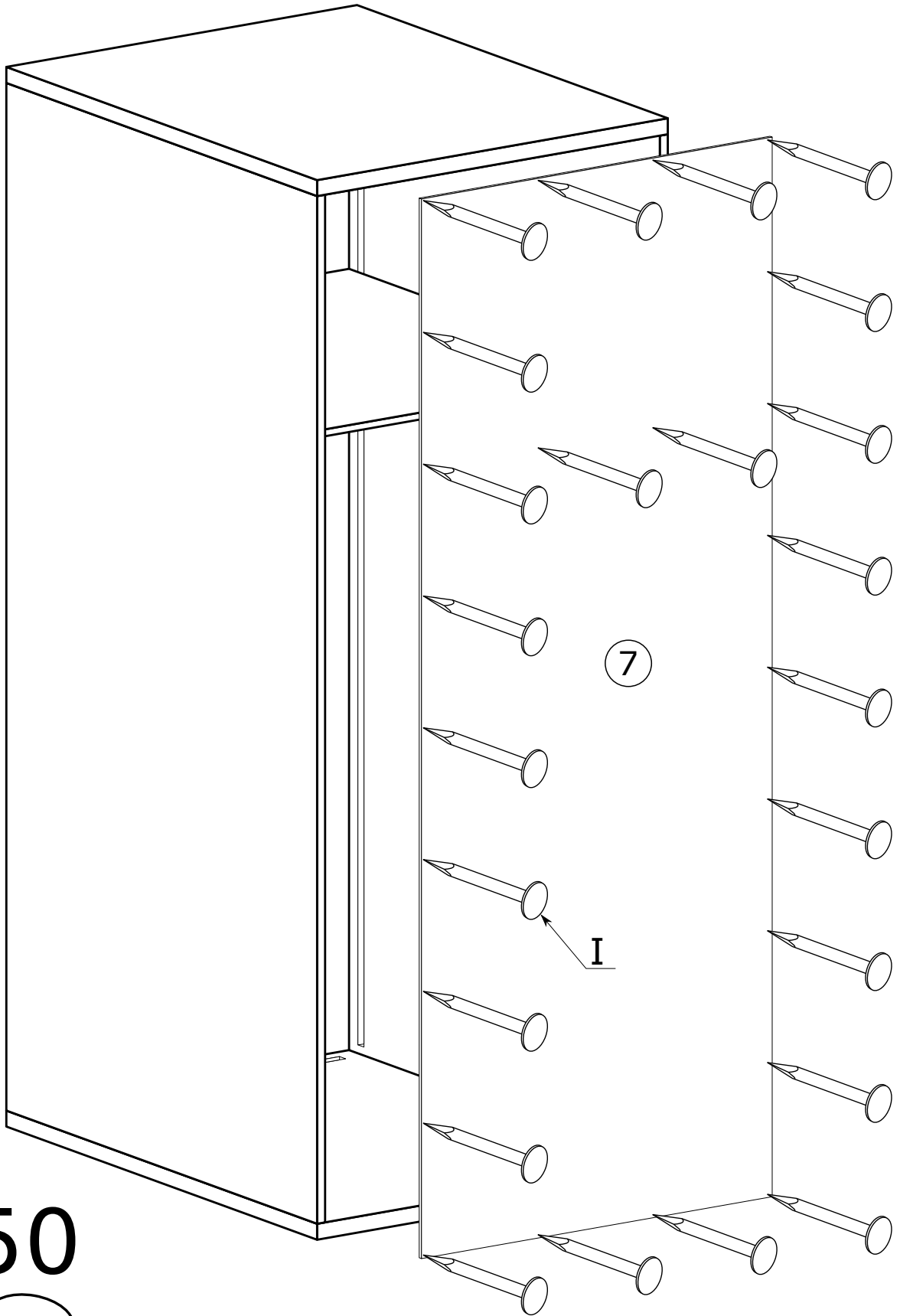

II

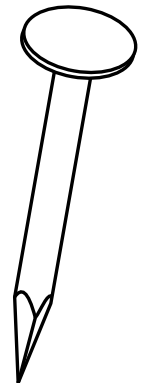

x50

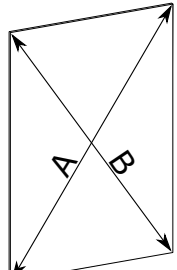

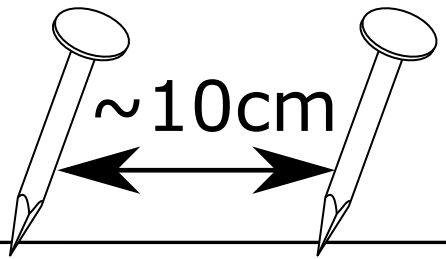
		
$A = B$		$\sim 10\text{cm}$

III

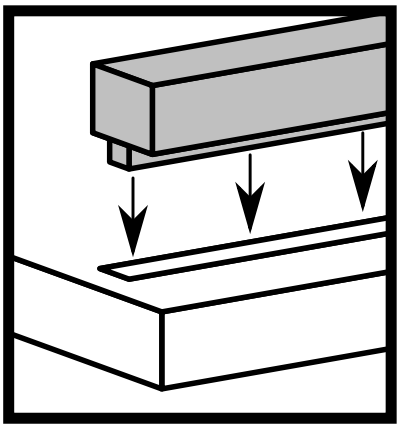
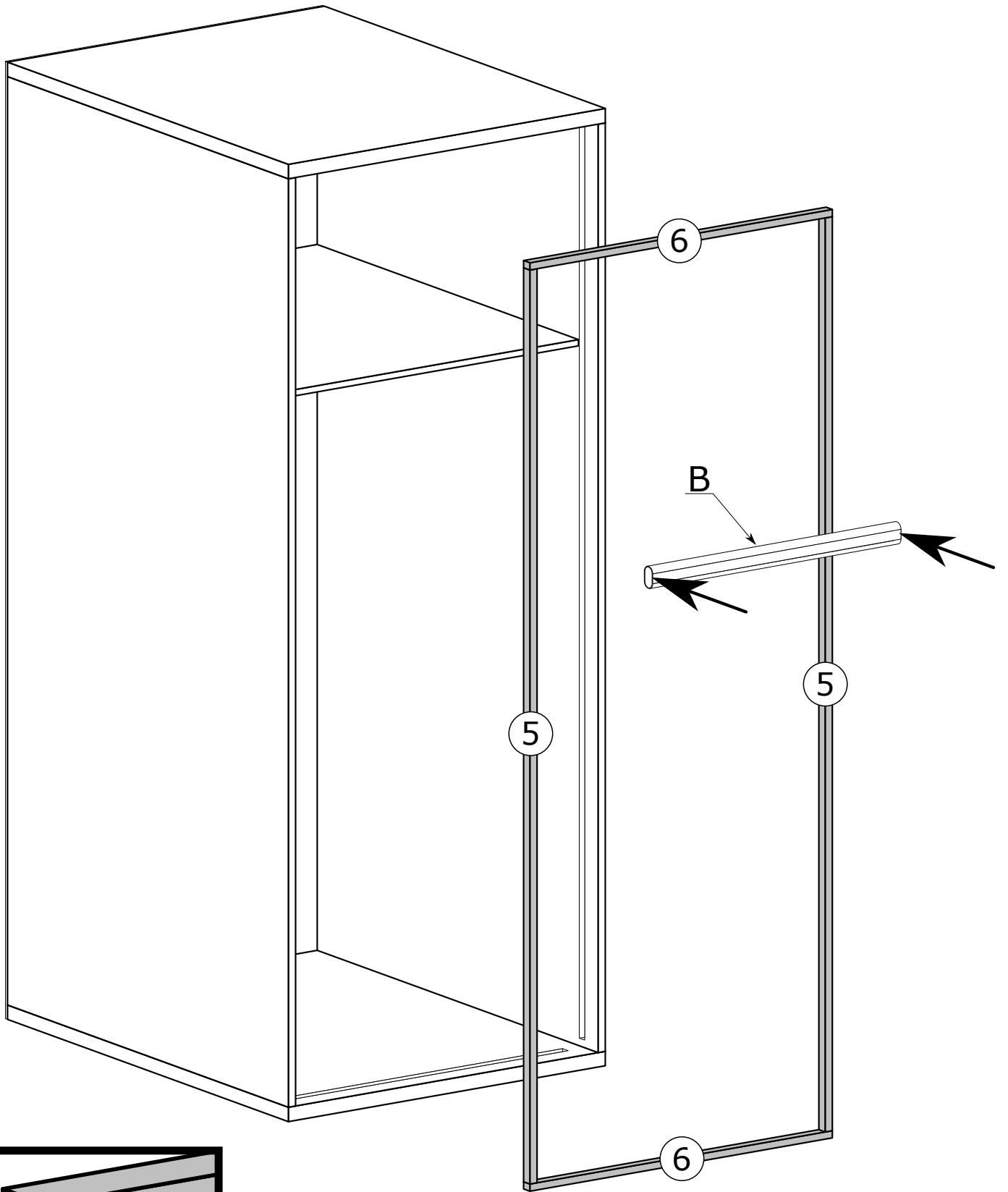

IV

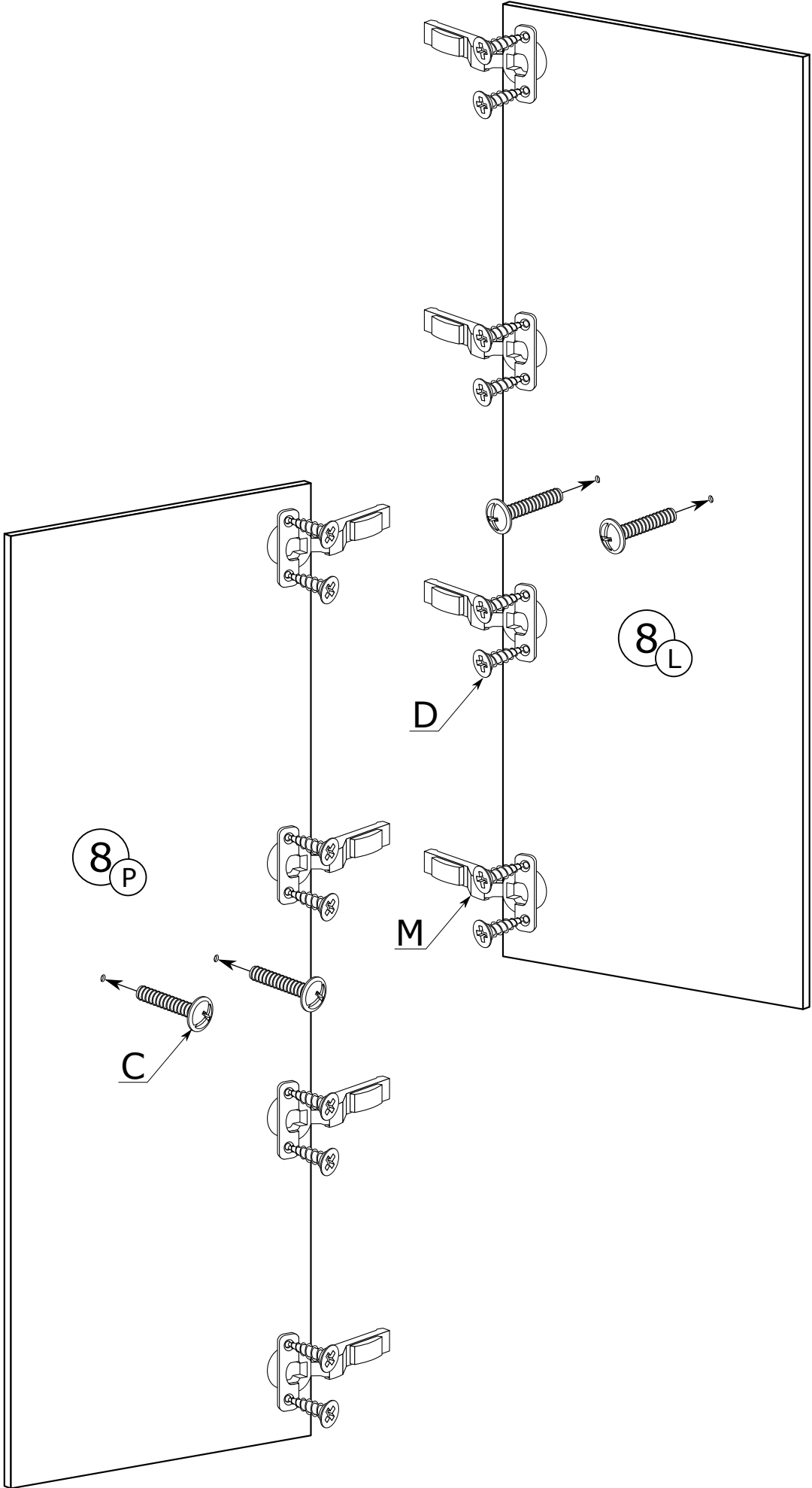
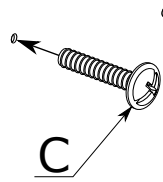
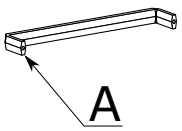

V

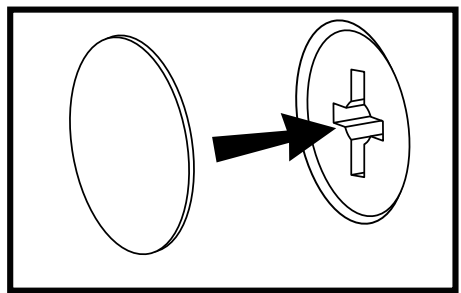
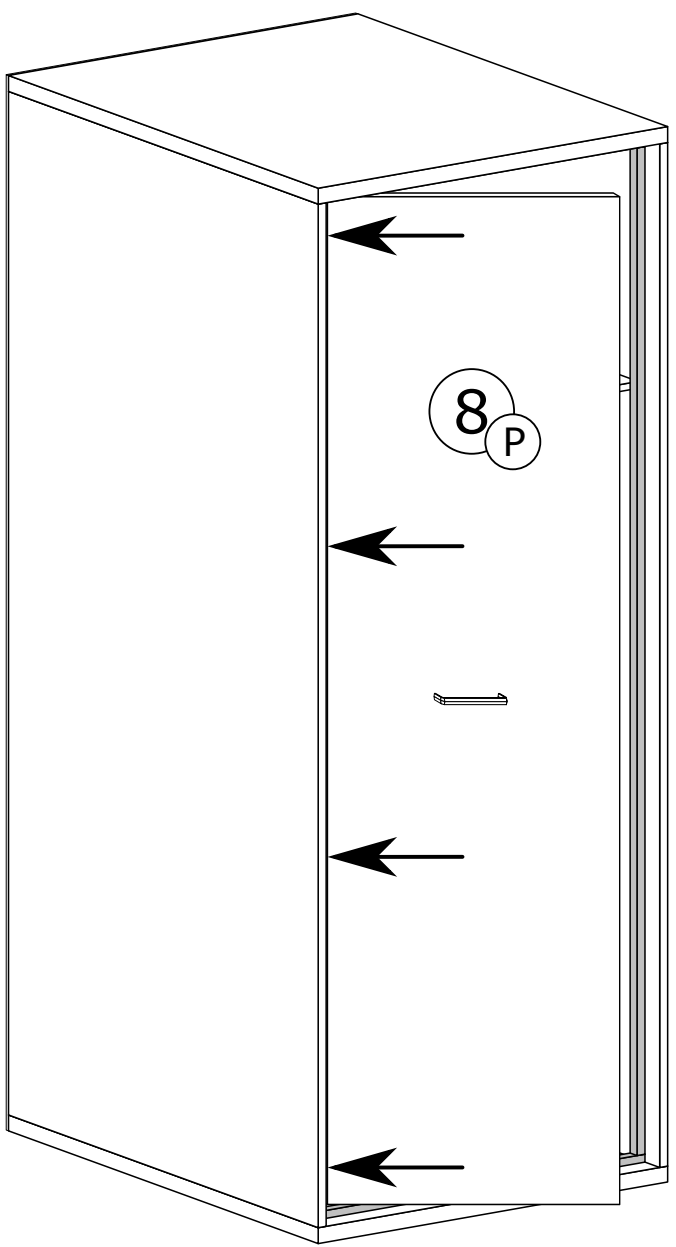
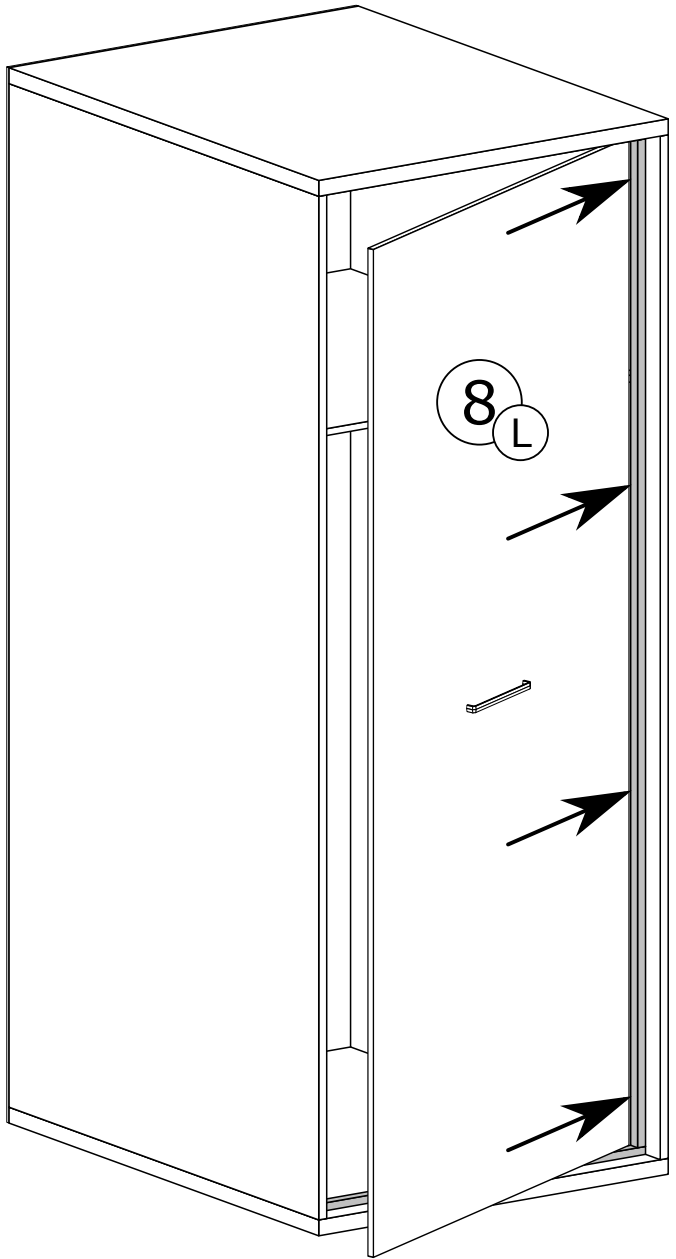

A

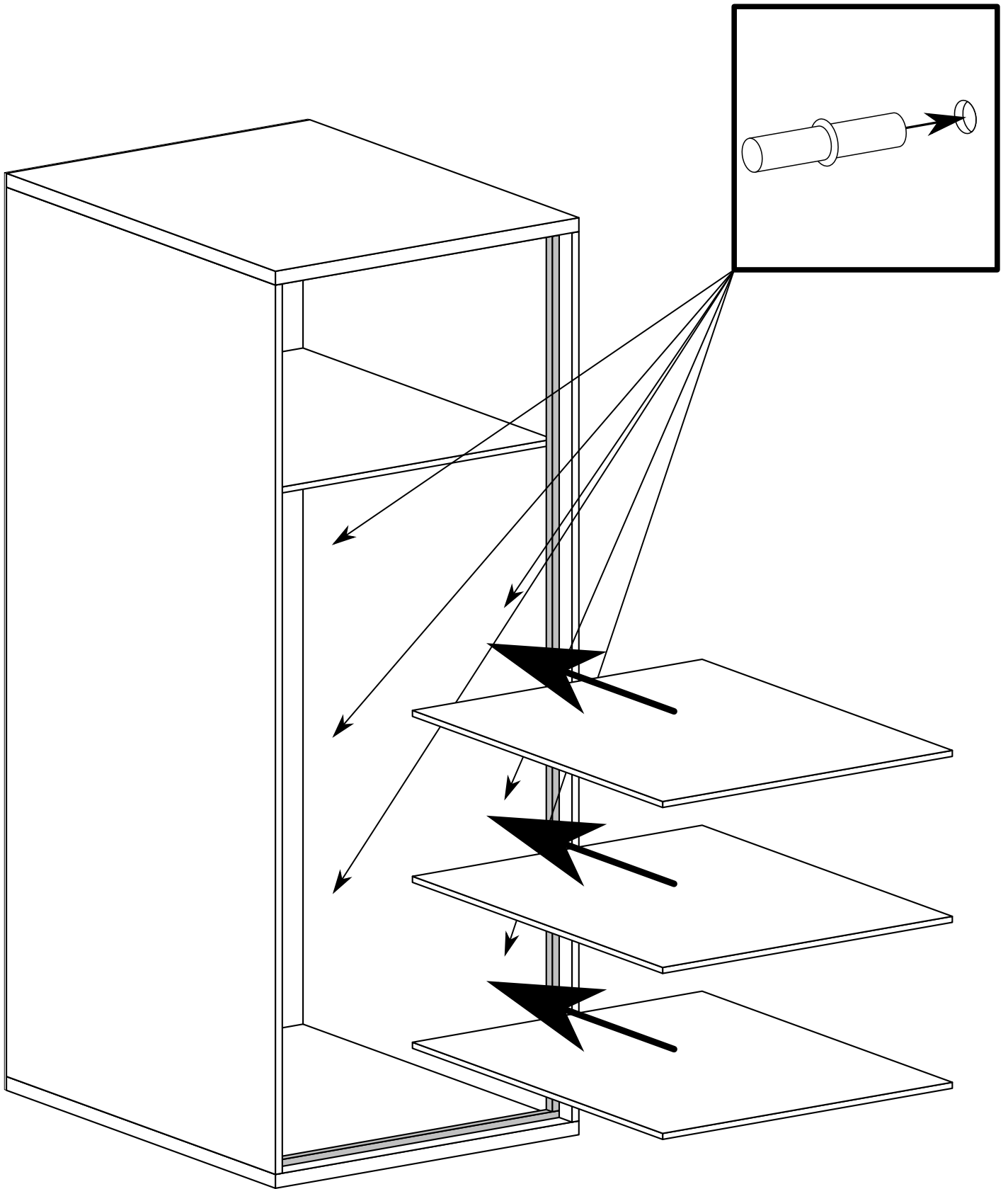



# MONTAŻ KĄTOWNIKA

