

MEDIOLAN 1

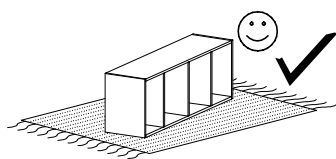

Narzędzia potrzebne do montażu

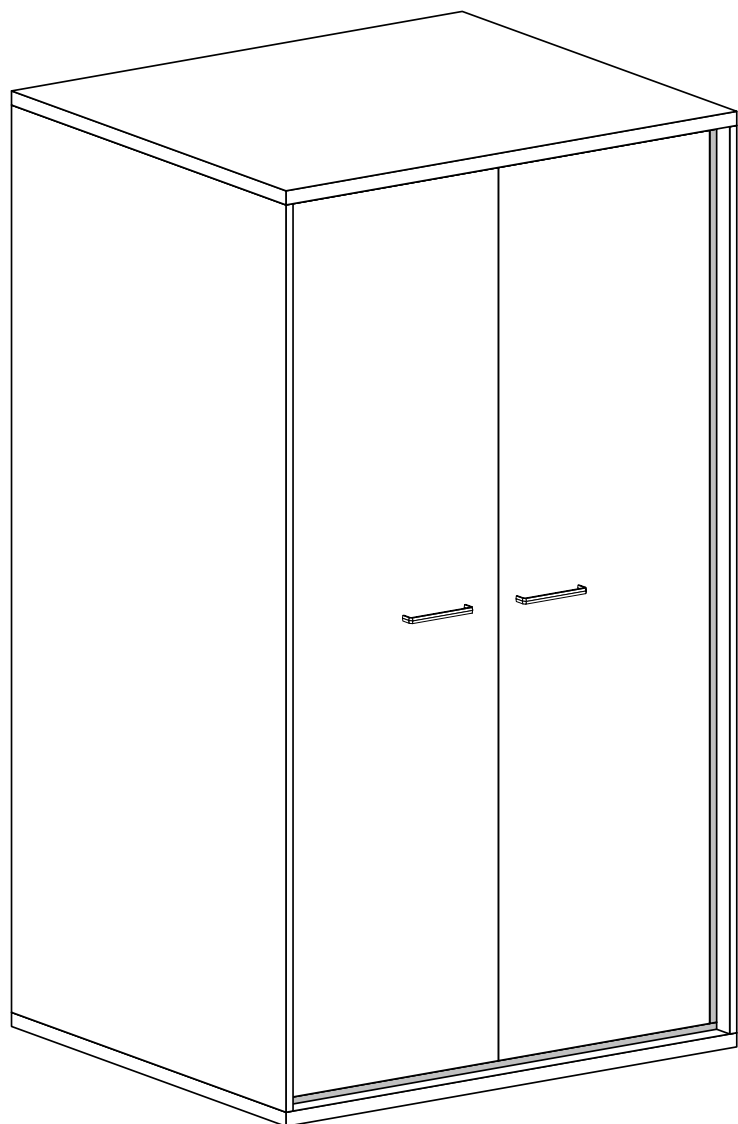
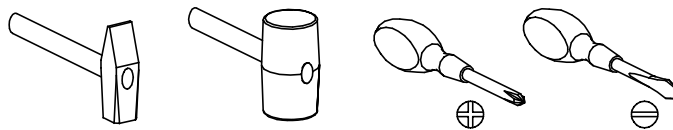

Nr	Nazwa elementu	D[mm]	S[mm]	G[mm]	Ilość
1	Bok P/L	1897	580	16	2
2	Błat Górny	921	581	32	1
3	Błat Dolny	921	581	32	1
4	Wieniec	889	542	16	1
5	Listwa	889	120	16	1
6	Listwa Czarna	1897	20	16	2
7	Listwa Czarna	856	20	16	2
8	Kapak	1940	458	2,5	2
9	Drzwi P/L	1856	422	16	2
A	Półka	889	542	16	3

UWAGA !!!

MONTOWANIE USZKODZONYCH
ELEMENTÓW POWODUJE UTRATĘ
GWARANCJI

UWAGA !!!

Mebel zawiera
elementy drewniane

W przypadku reklamacji proszę podać numer pakowacza znajdujący się na kartonie.

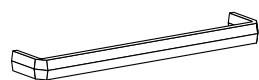

A - 2 St.



B - 1 St.
881 mm

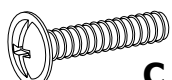

C - 4 St.
4x22 mm

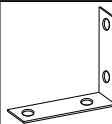

Y1 - 1 St.

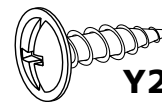

Y2 - 2 St.
3,5x16 mm

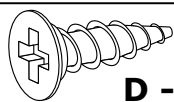

D - 35 St.
3,5x16 mm

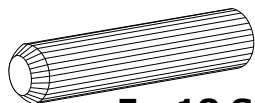

E - 18 St.

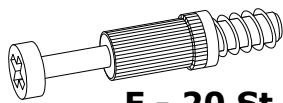

F - 20 St.

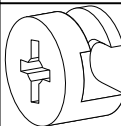

G - 20 St.

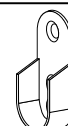

H - 2 St.

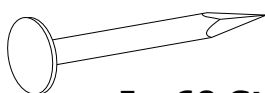

I - 60 St.

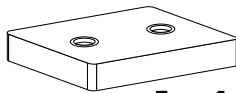

J - 4 St.



X1 - 26 St.



Z - 1 St.

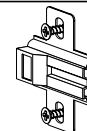

L - 8 St.

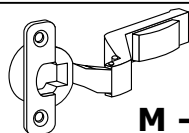

M - 8 St.

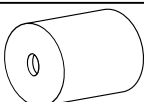

N - 16 St.

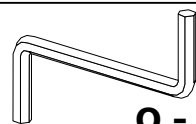

O - 1 St.

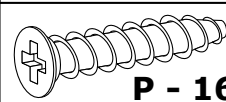

P - 16 St.
6,3x30 mm

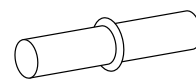

*** - 12 St.**

I

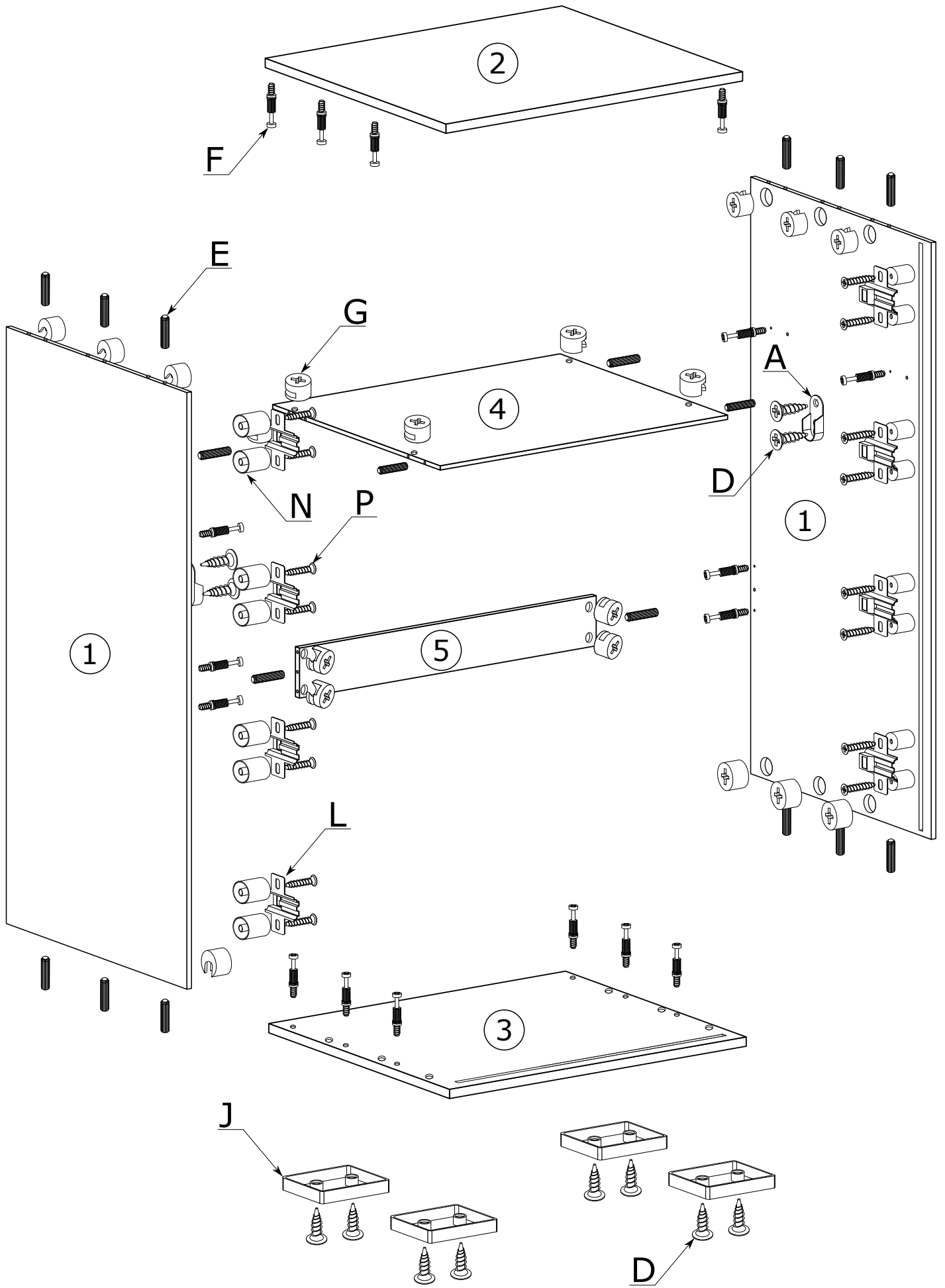

II

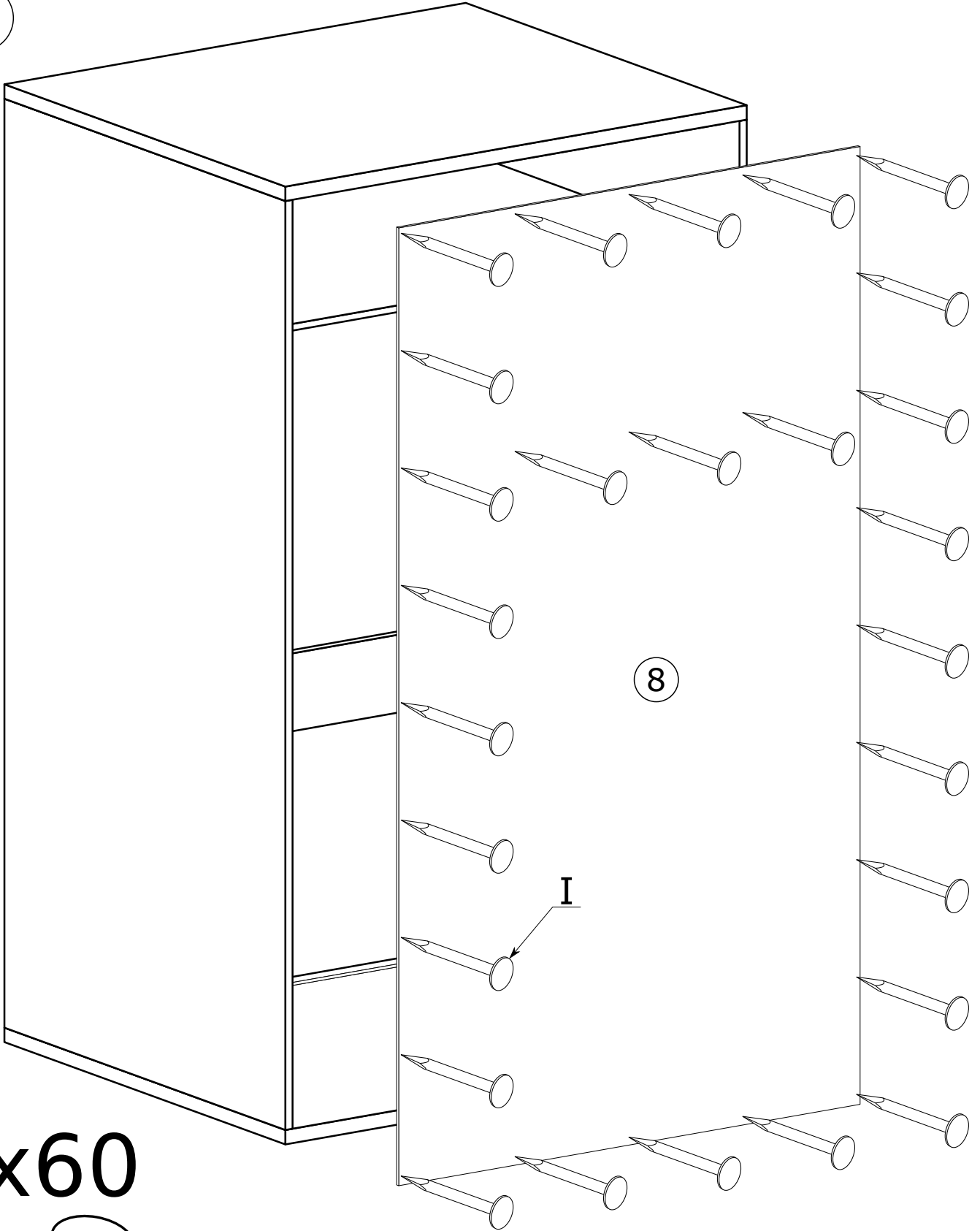

x60

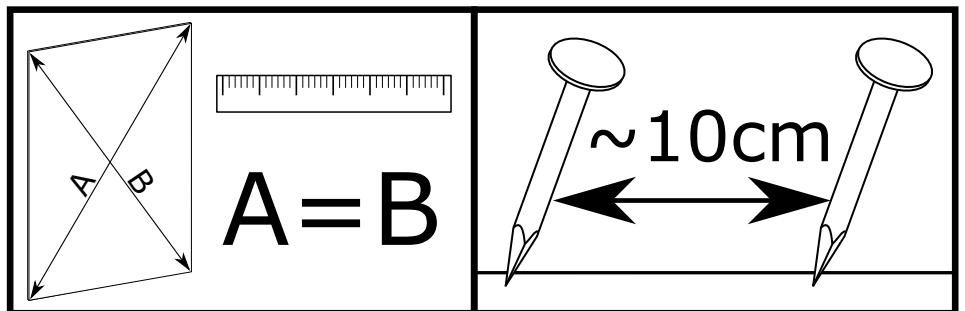
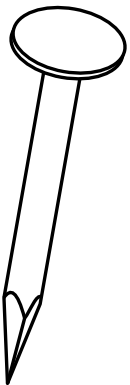

III

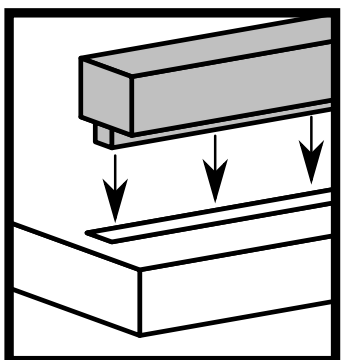
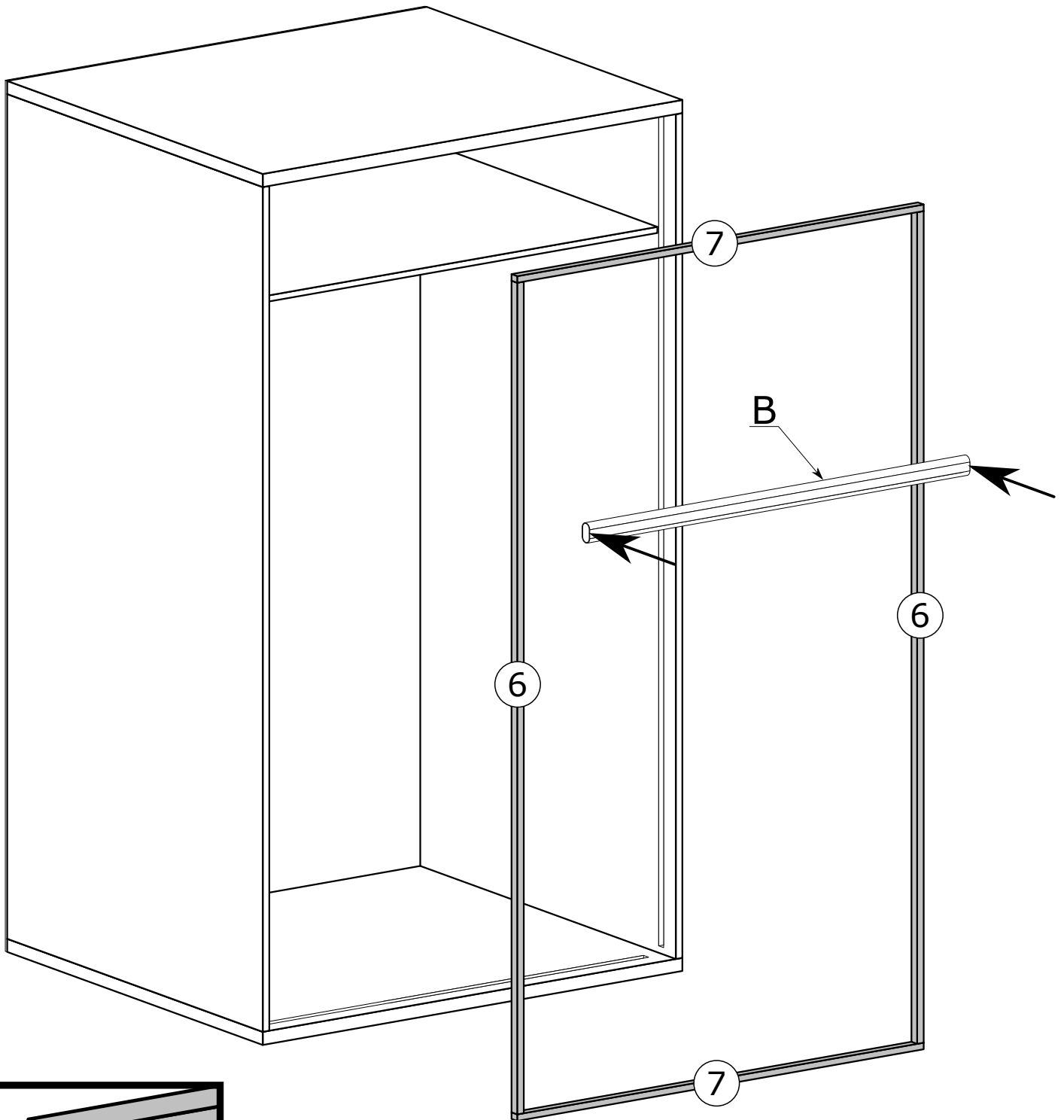

IV

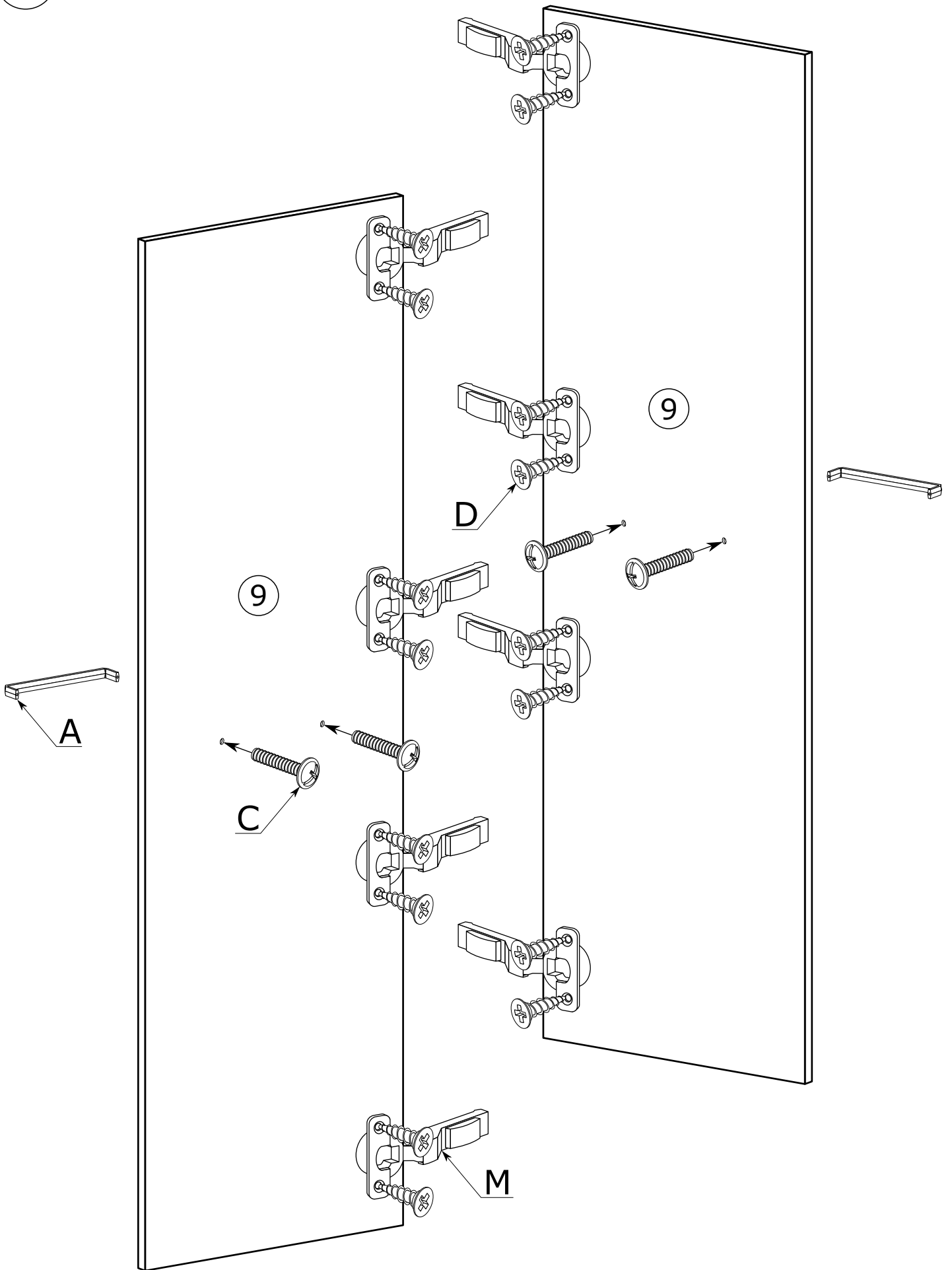

V

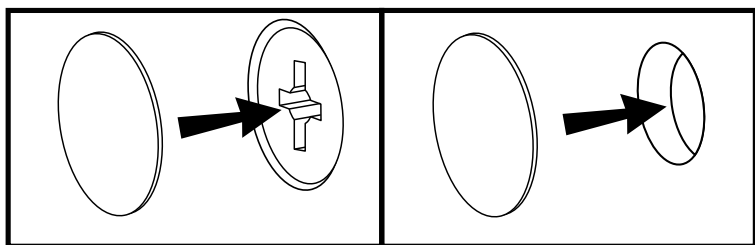
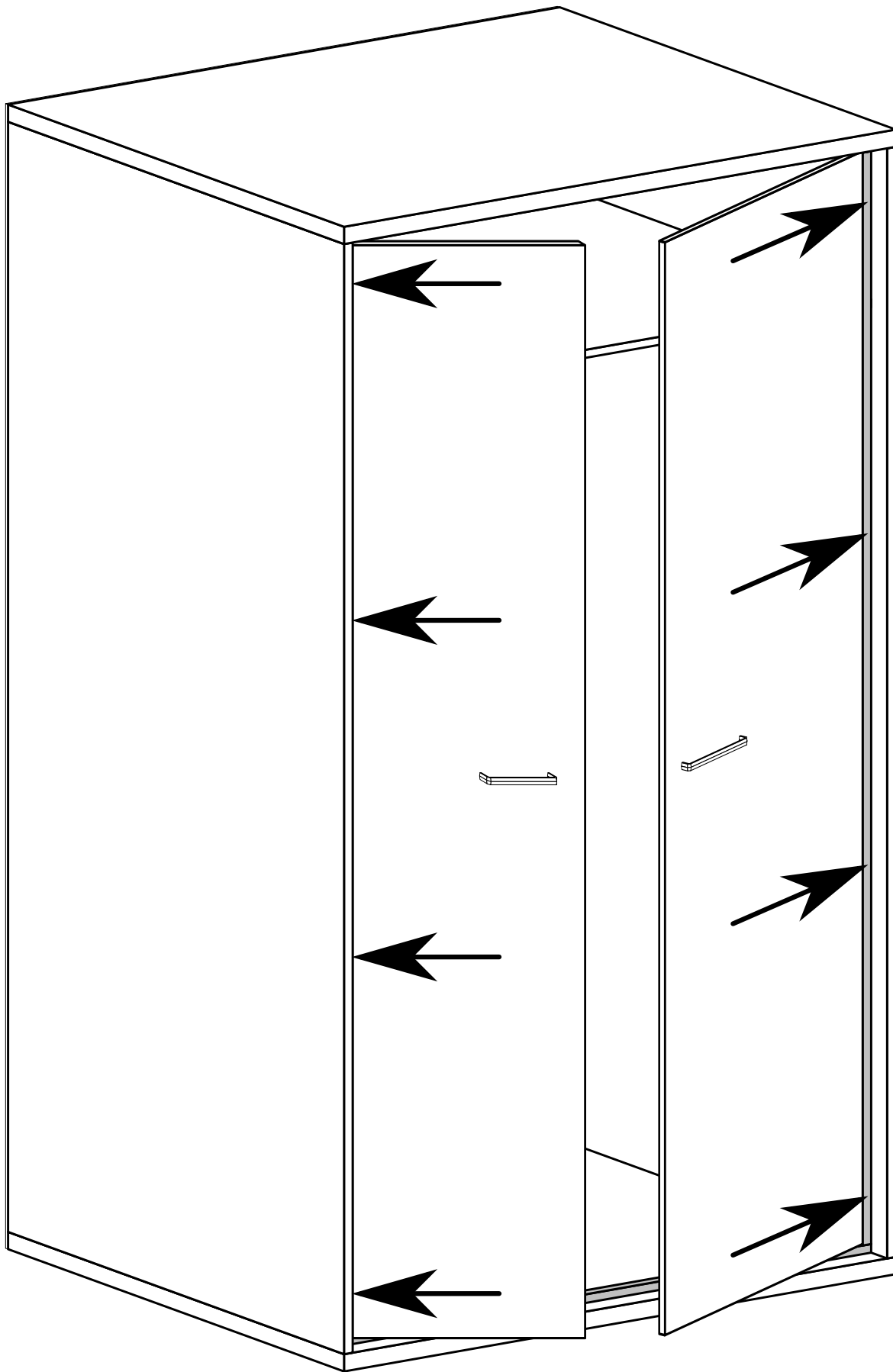

A

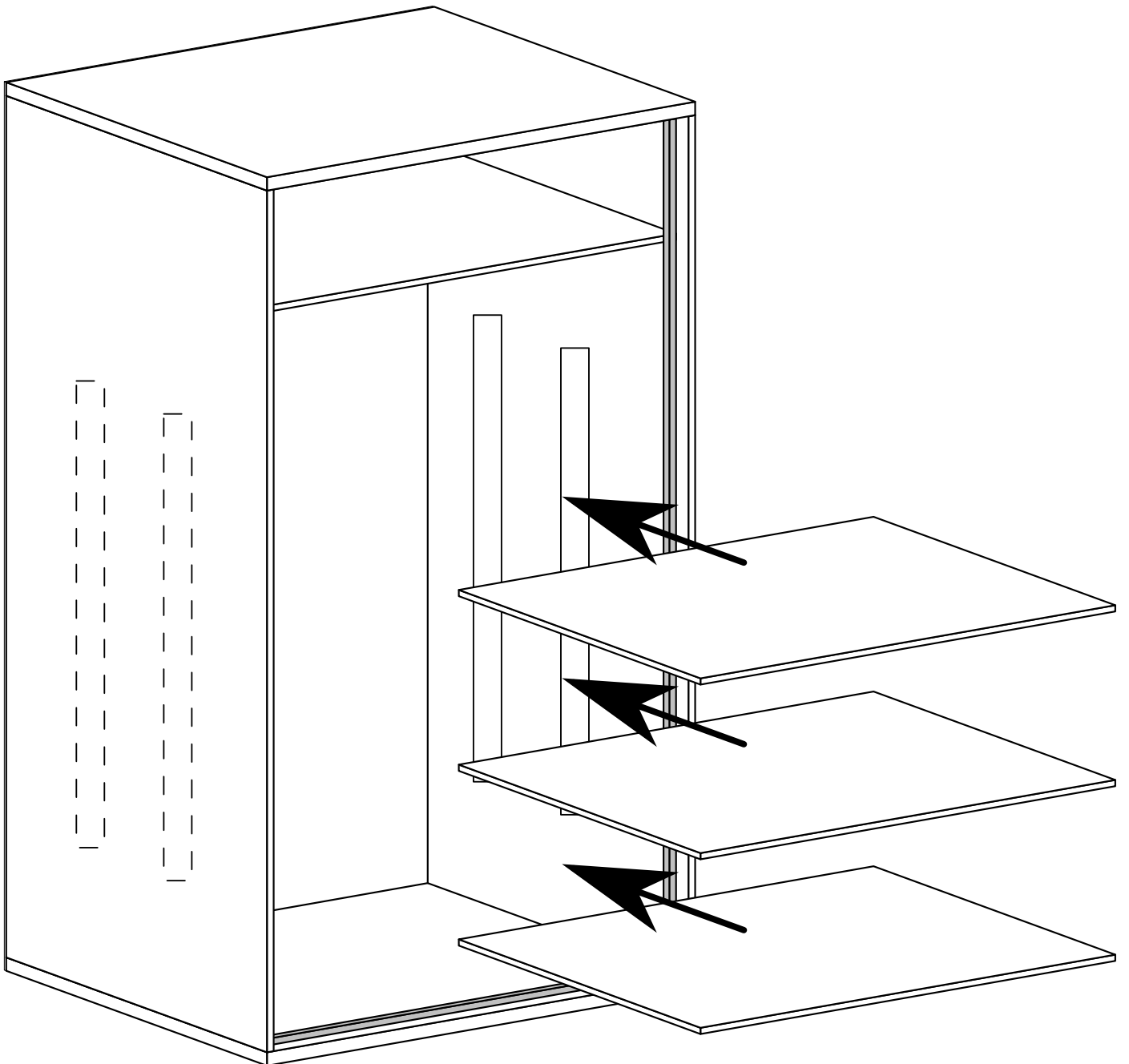
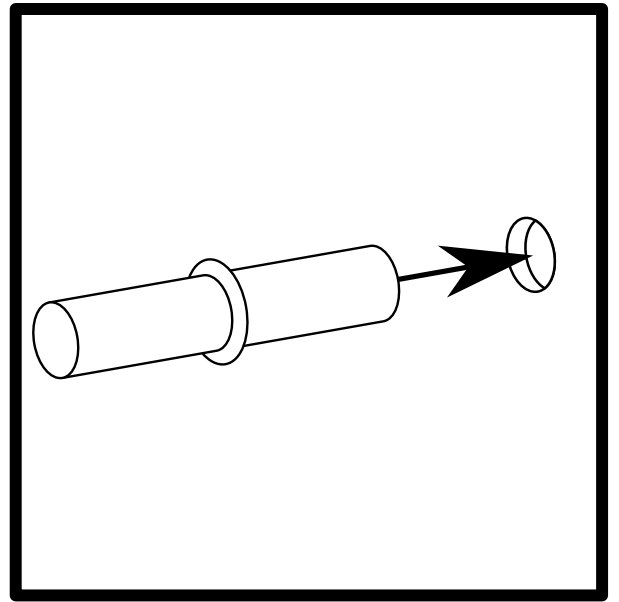

MONTAŻ KĄTOWNIKA

