

KORA 16

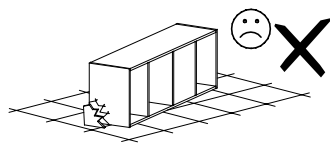

Narzędzia potrzebne do montażu

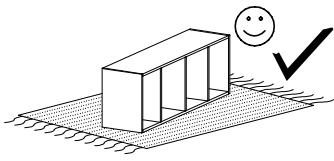
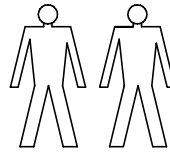
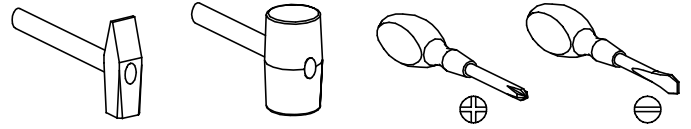

UWAGA !!!

MONTOWANIE USZKODZONYCH
ELEMENTÓW POWODUJE UTRATĘ
GWARANCJI

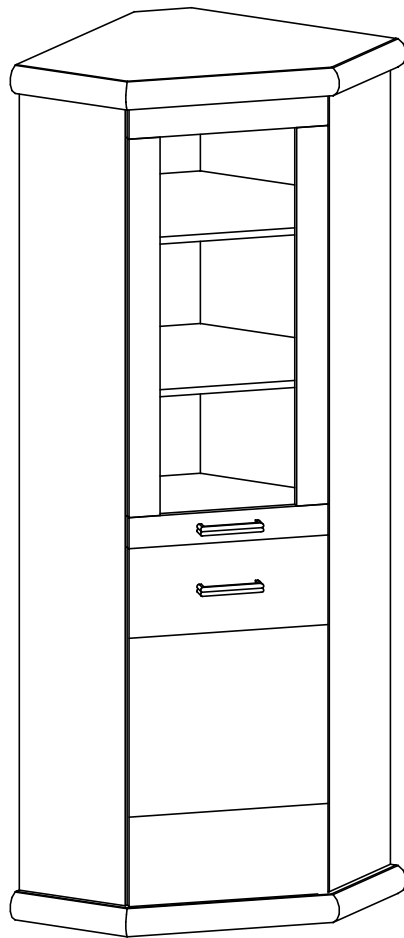

Nr	D[mm]	S[mm]	G[mm]	Ilość
1	625	625	65	1
2	625	625	65	1
3	1835	268	16	1
4	1835	268	16	1
5	1835	195	16	1
6	578	578	16	3
7	578	578	16	1
8	1860	468	2,5	2
9	1005	443	16	1
10	773	443	16	1

UWAGA !!!

Mebel zawiera
elementy drewniane

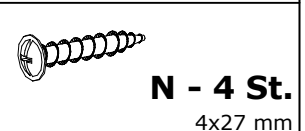
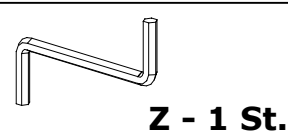
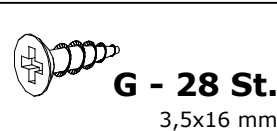
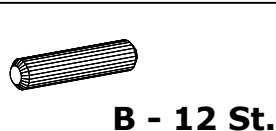
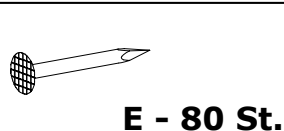
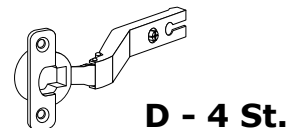
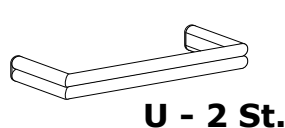
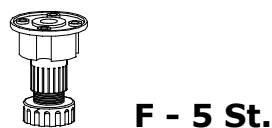
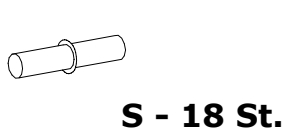
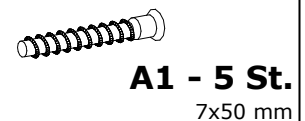
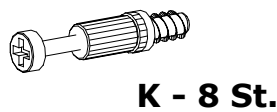
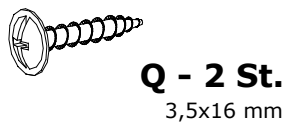
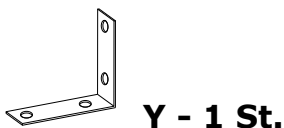

W przypadku reklamacji proszę podać numer pakowacza znajdujący się na kartonie.

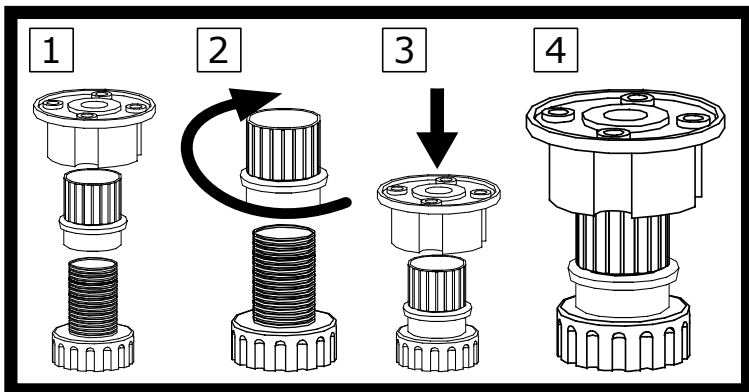
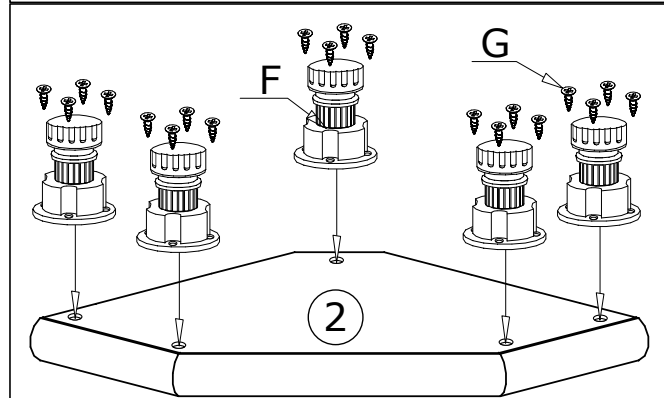
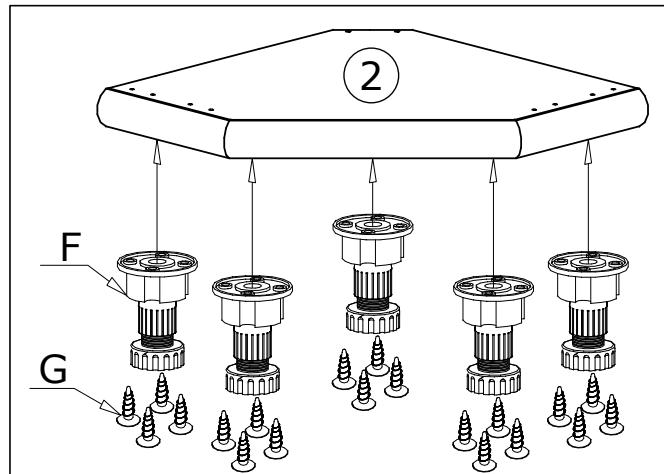
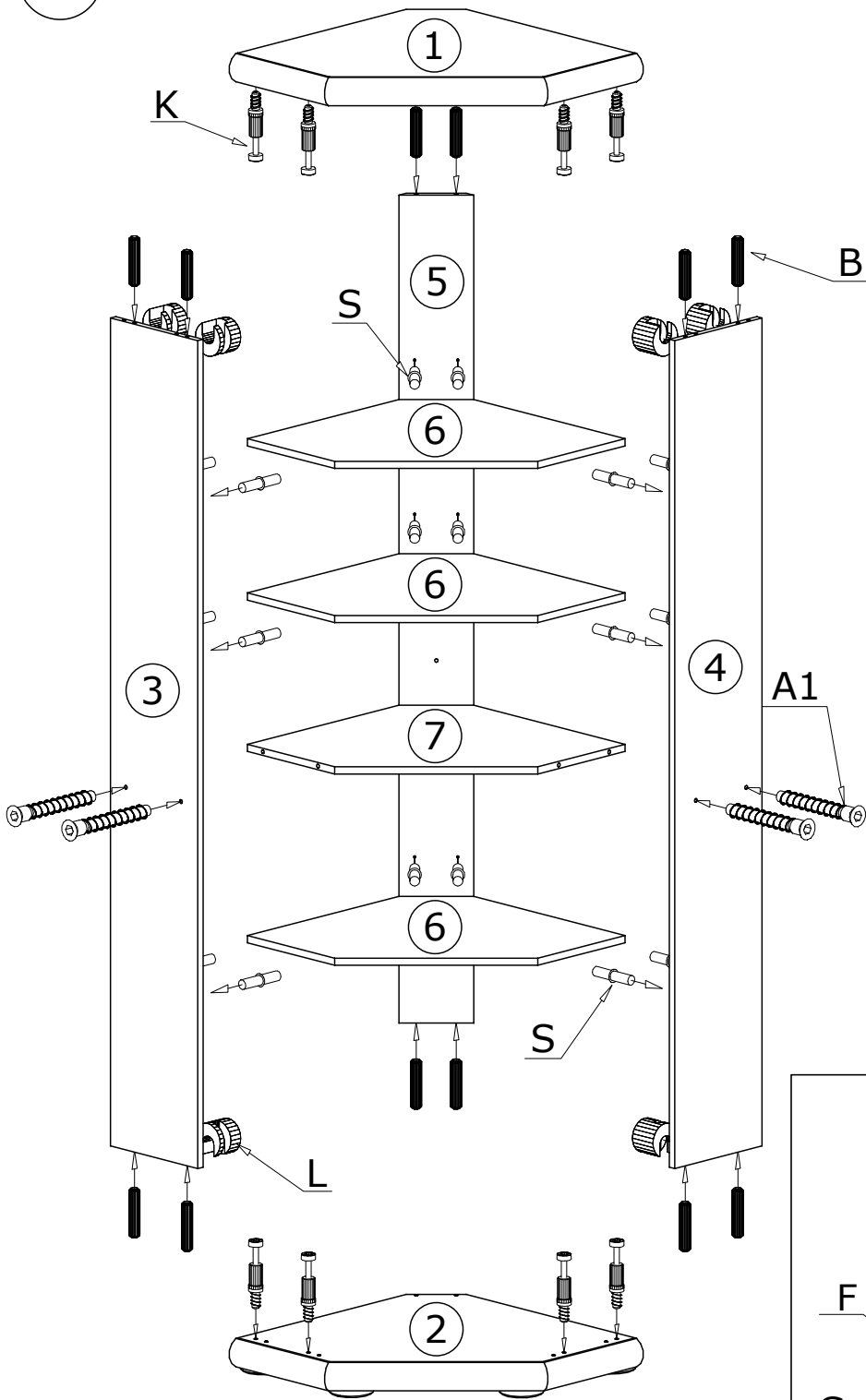

I

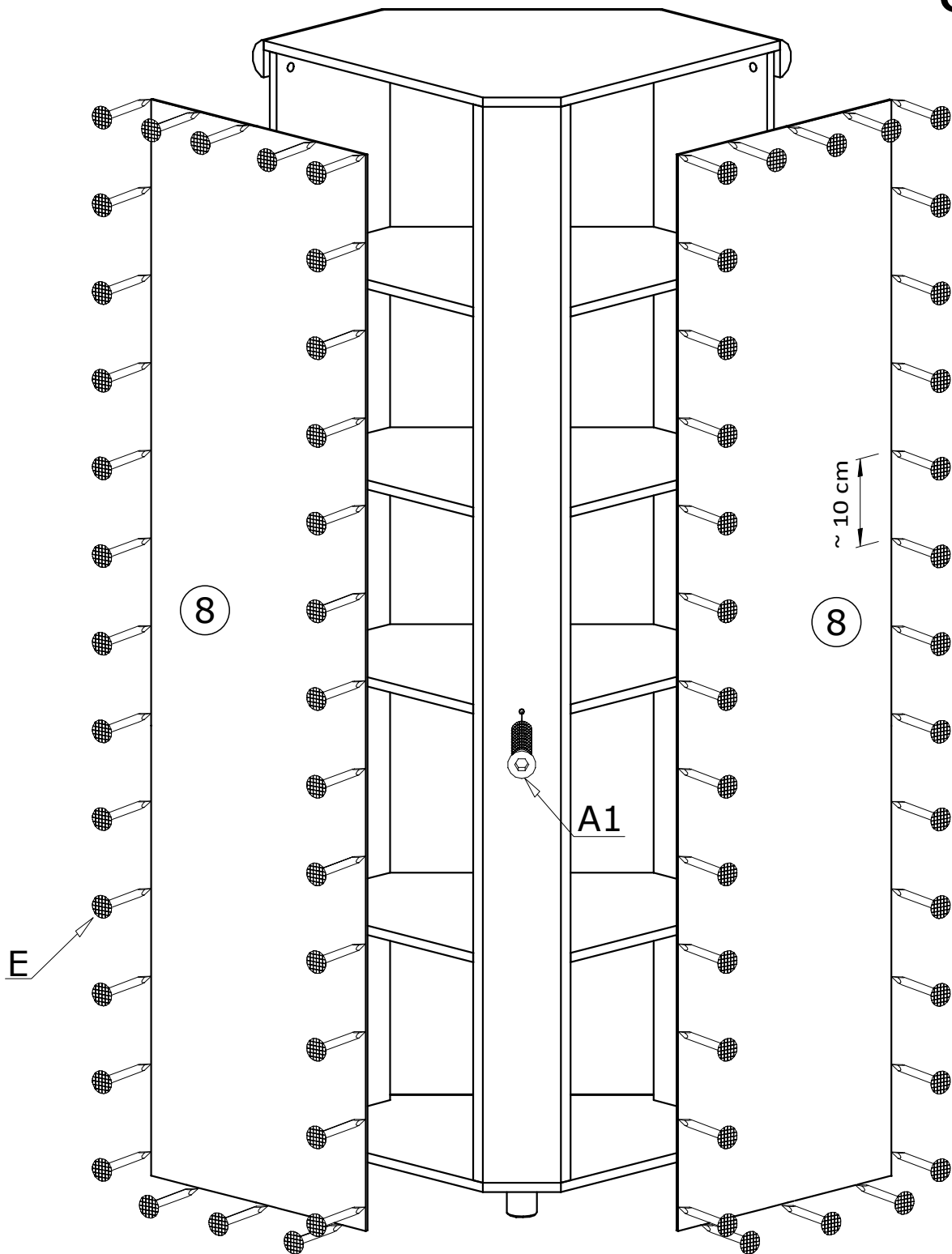

II

80X 

Meble zawierają elementy drewniane, których barwa i układ słoików są uzależnione od wielu czynników, dlatego mogą występować różnice w fakturze i barwie co nie stanowi wady produktu i nie wpływa na jego jakość, trwałość i funkcjonalność.

Listwy drewniane mogą ujawniać niewielkie zmiany w kształcie i wymiarach wywołane specyficznymi warunkami eksploatacji takimi jak: wilgotność, różnice temperatur, etc.

III

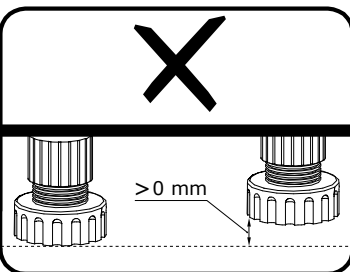
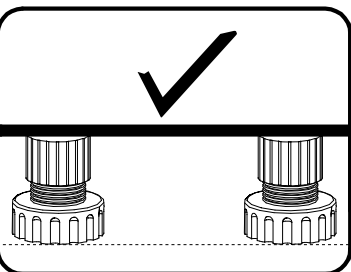
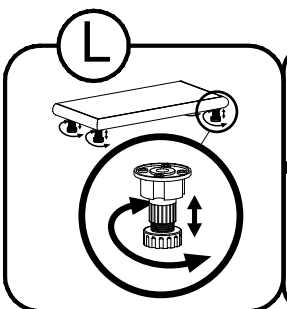
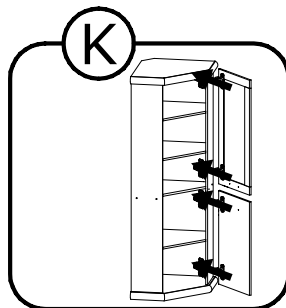
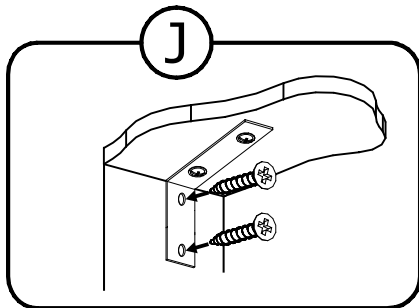
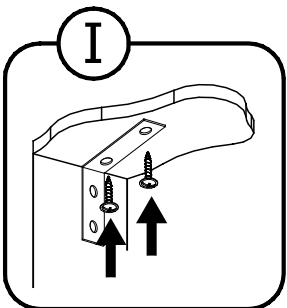
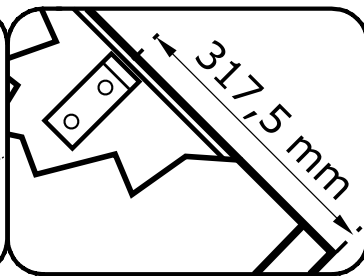
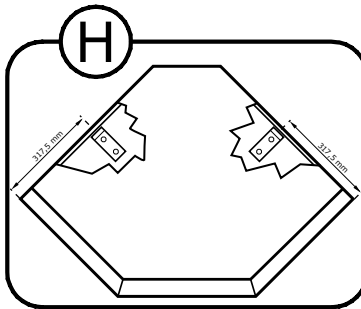
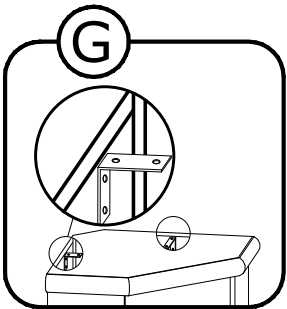
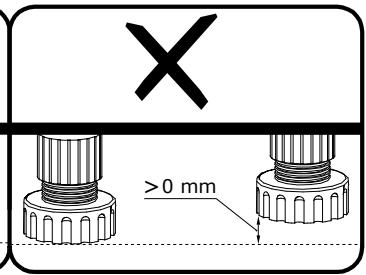
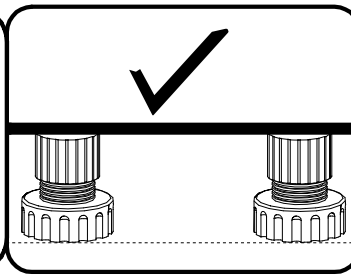
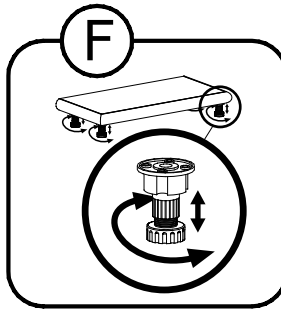
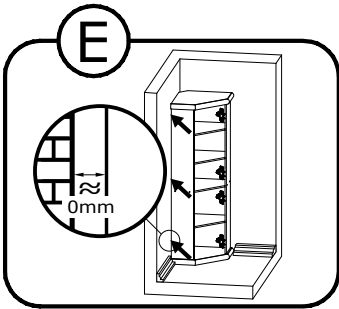
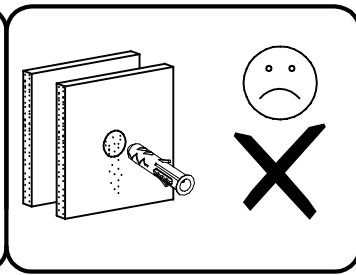
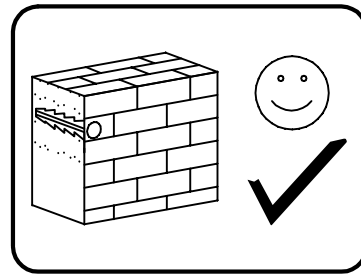
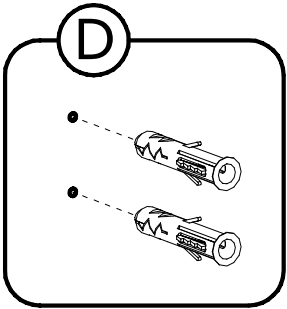
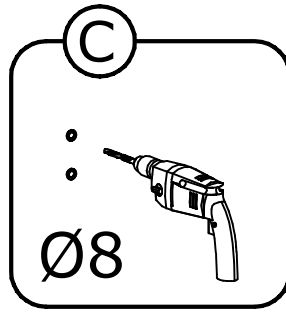
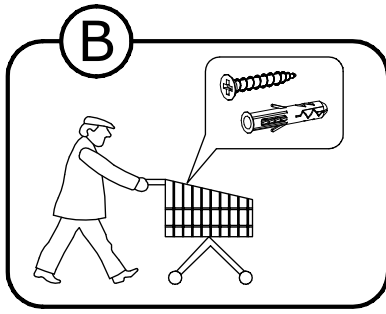
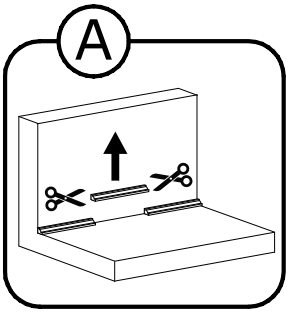

IV

