

KORA 15

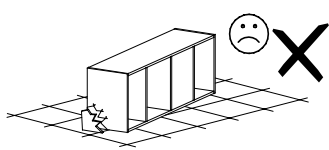

Narzędzia potrzebne do montażu

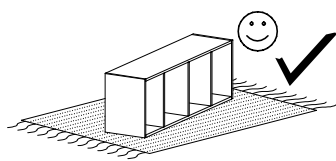

UWAGA !!!

MONTOWANIE USZKODZONYCH
ELEMENTÓW POWODUJE UTRATĘ
GWARANCJI

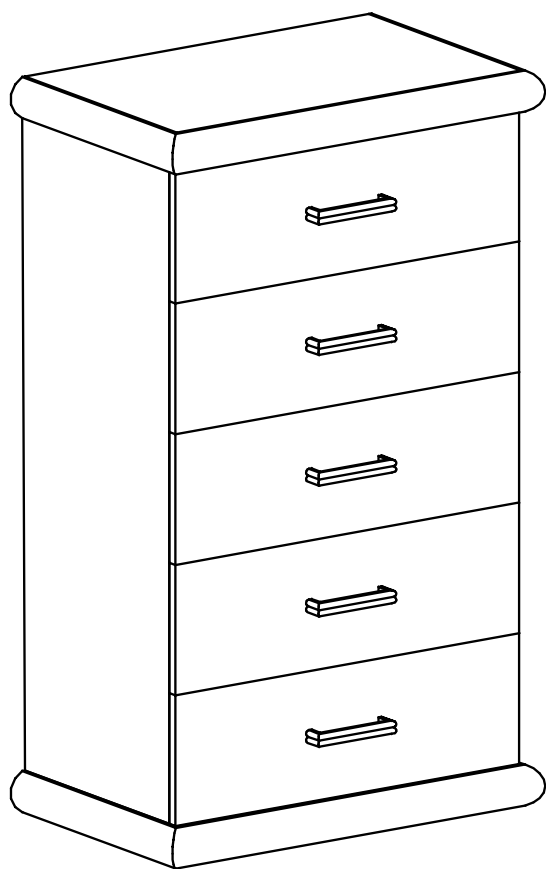

| Nr | D[mm] | S[mm] | G[mm] | Ilość |
|----|-------|-------|-------|-------|
| 1 | 700 | 450 | 65 | 1 |
| 2 | 700 | 450 | 65 | 1 |
| 3 | 1020 | 410 | 16 | 1 |
| 4 | 1020 | 410 | 16 | 1 |
| 5 | 1045 | 634 | 2,5 | 1 |
| 6 | 580 | 355 | 2,5 | 5 |
| 7 | 350 | 150 | 16 | 10 |
| 8 | 552 | 150 | 16 | 5 |
| 9 | 635 | 190 | 16 | 5 |

UWAGA !!!

Mebel zawiera
elementy drewniane

W przypadku reklamacji proszę podać numer pakowacza znajdujący się na kartonie.

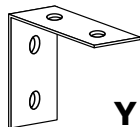

Y - 1 St.

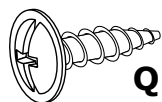

Q - 2 St.
3,5x16 mm



J - 40 St.
5x13 mm

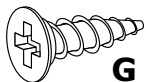

G - 16 St.
3,5x16 mm



X1 - 34 St.

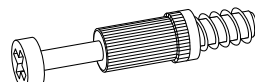

K - 18 St.



L - 18 St.



P - 20 St.
7x50 mm

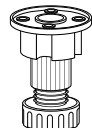

F - 4 St.



U - 5 St.

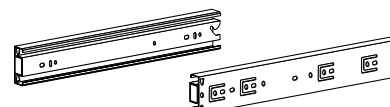

T - 5 Kpl.



E - 50 St.



B - 28 St.

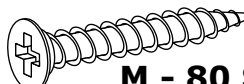

M - 80 St.
3x30 mm

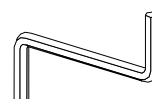

Z - 1 St.

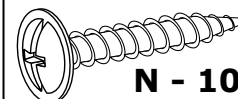

N - 10 St.
4x27 mm

I

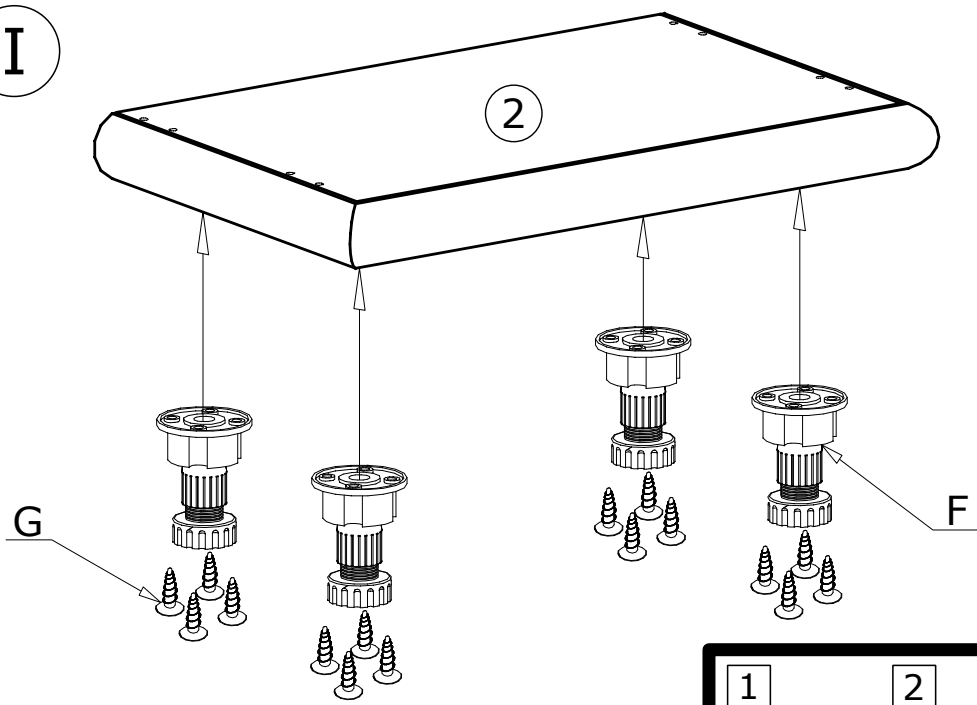

II

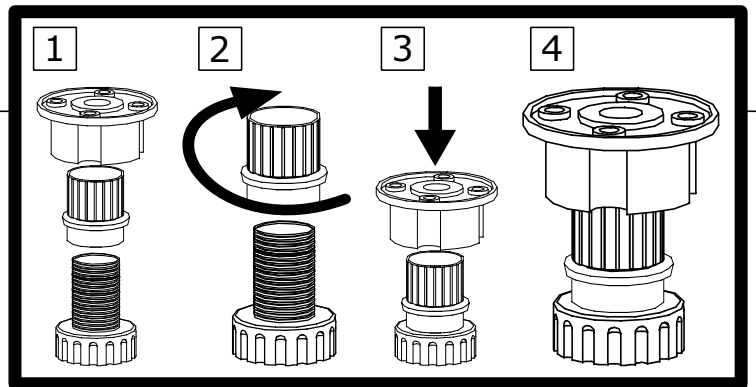
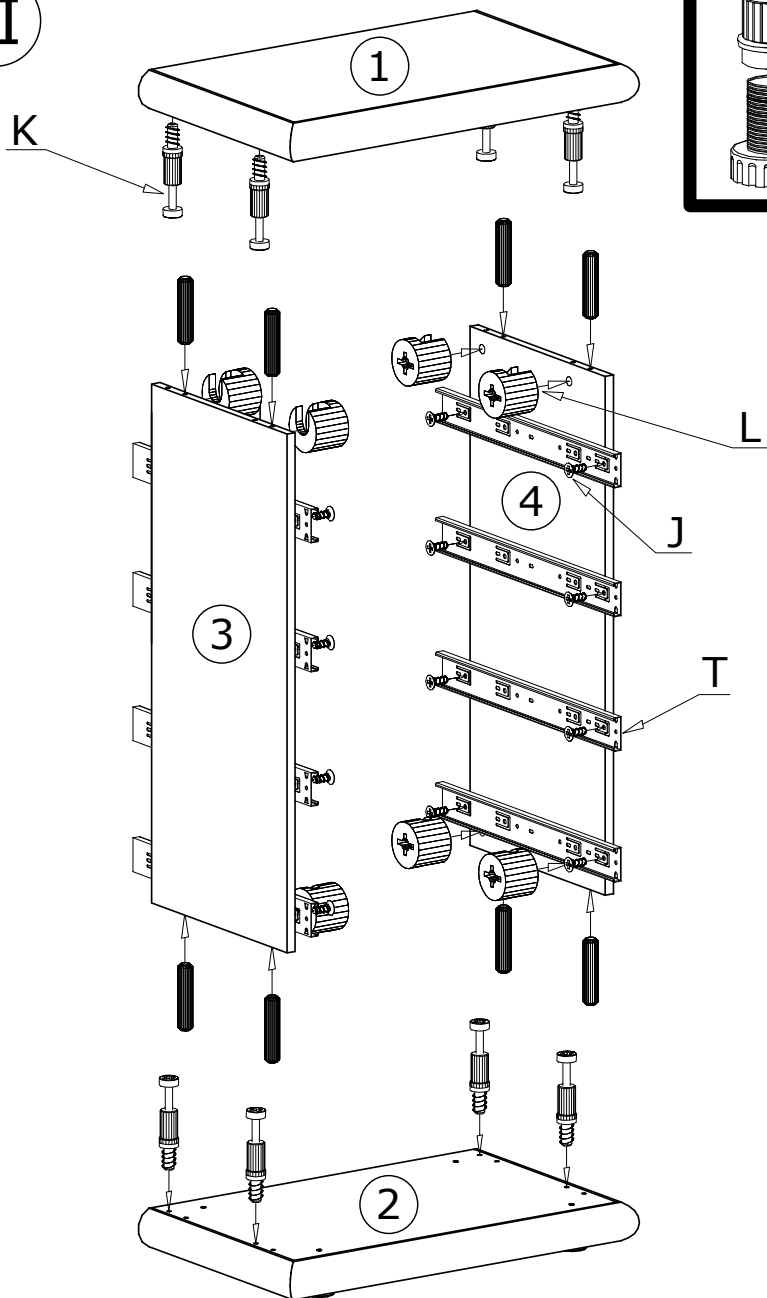

III

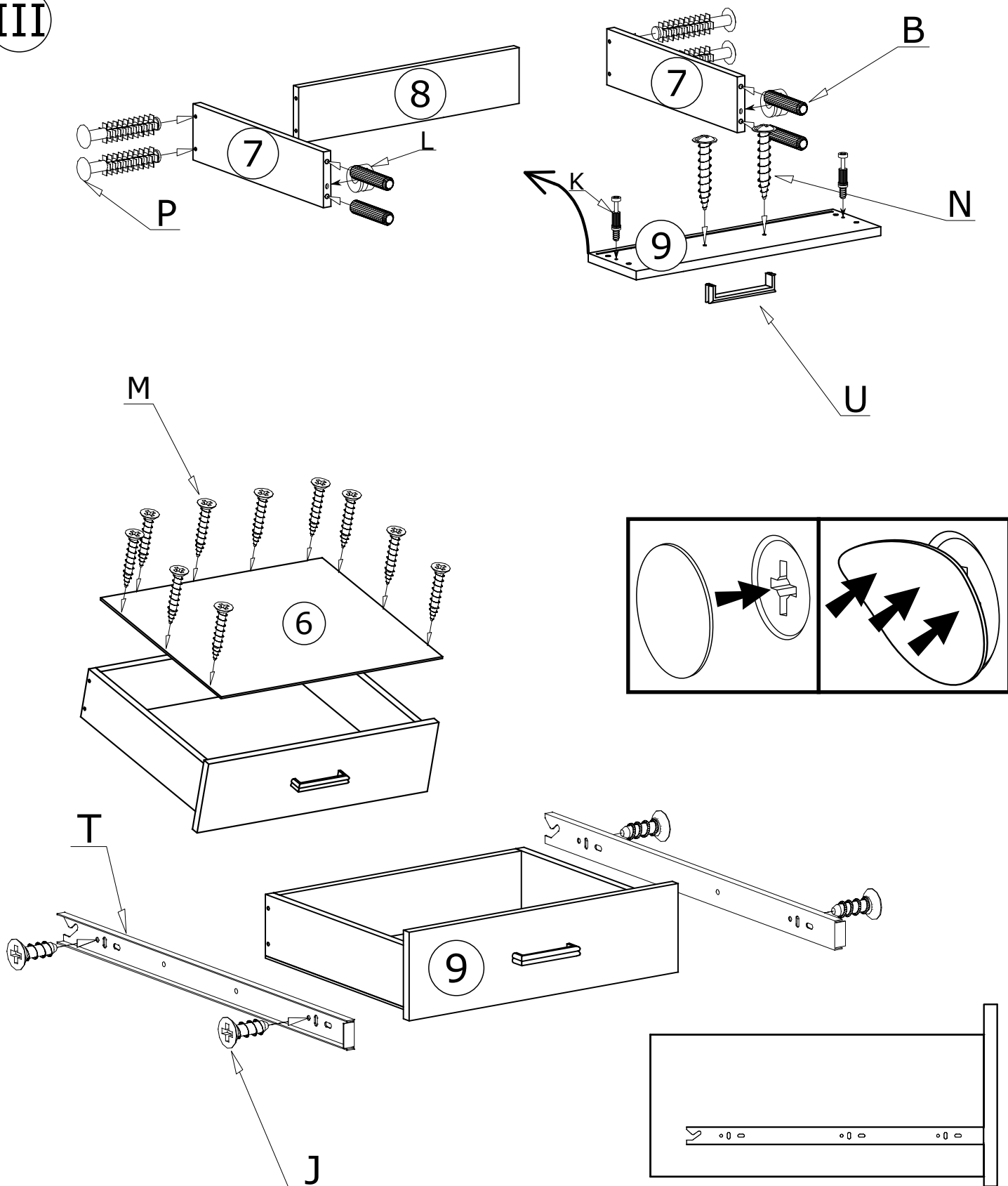

Meble zawierają elementy drewniane, których barwa i układ słojów są uzależnione od wielu czynników, dlatego mogą występować różnice w fakturze i barwie co nie stanowi wady produktu i nie wpływa na jego jakość, trwałość i funkcjonalność.

Listwy drewniane mogą ujawniać niewielkie zmiany w kształcie i wymiarach wywołane specyficznymi warunkami eksploatacji takimi jak: wilgotność, różnice temperatur, etc.

IV

50X 

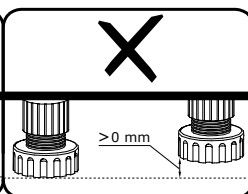
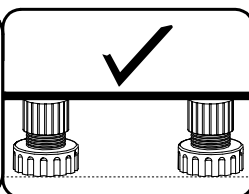
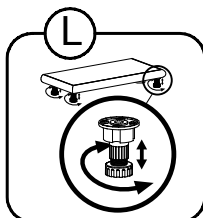
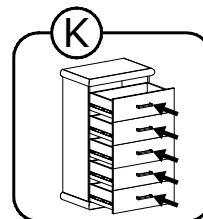
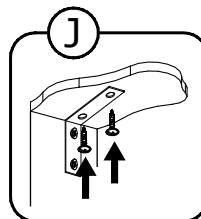
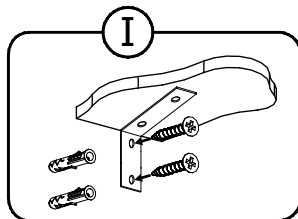
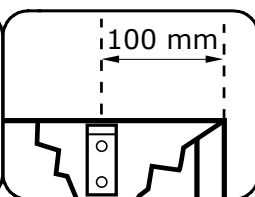
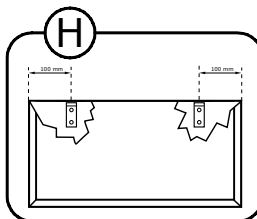
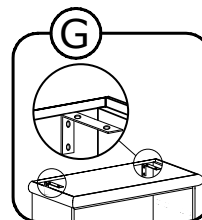
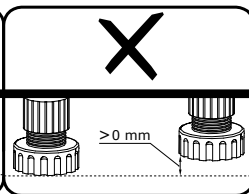
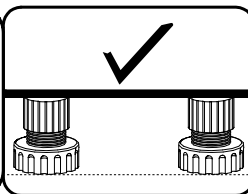
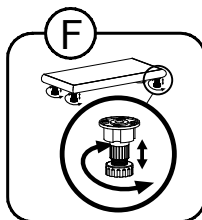
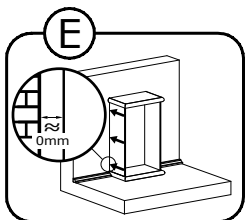
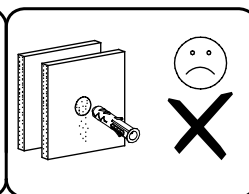
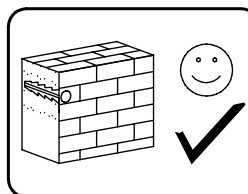
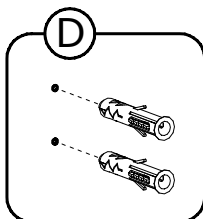
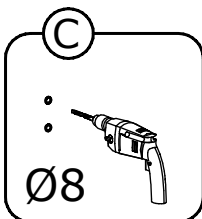
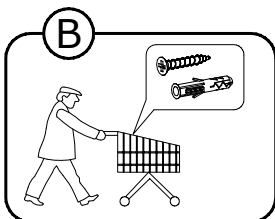
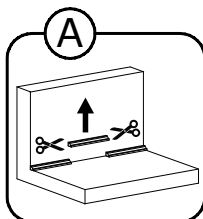
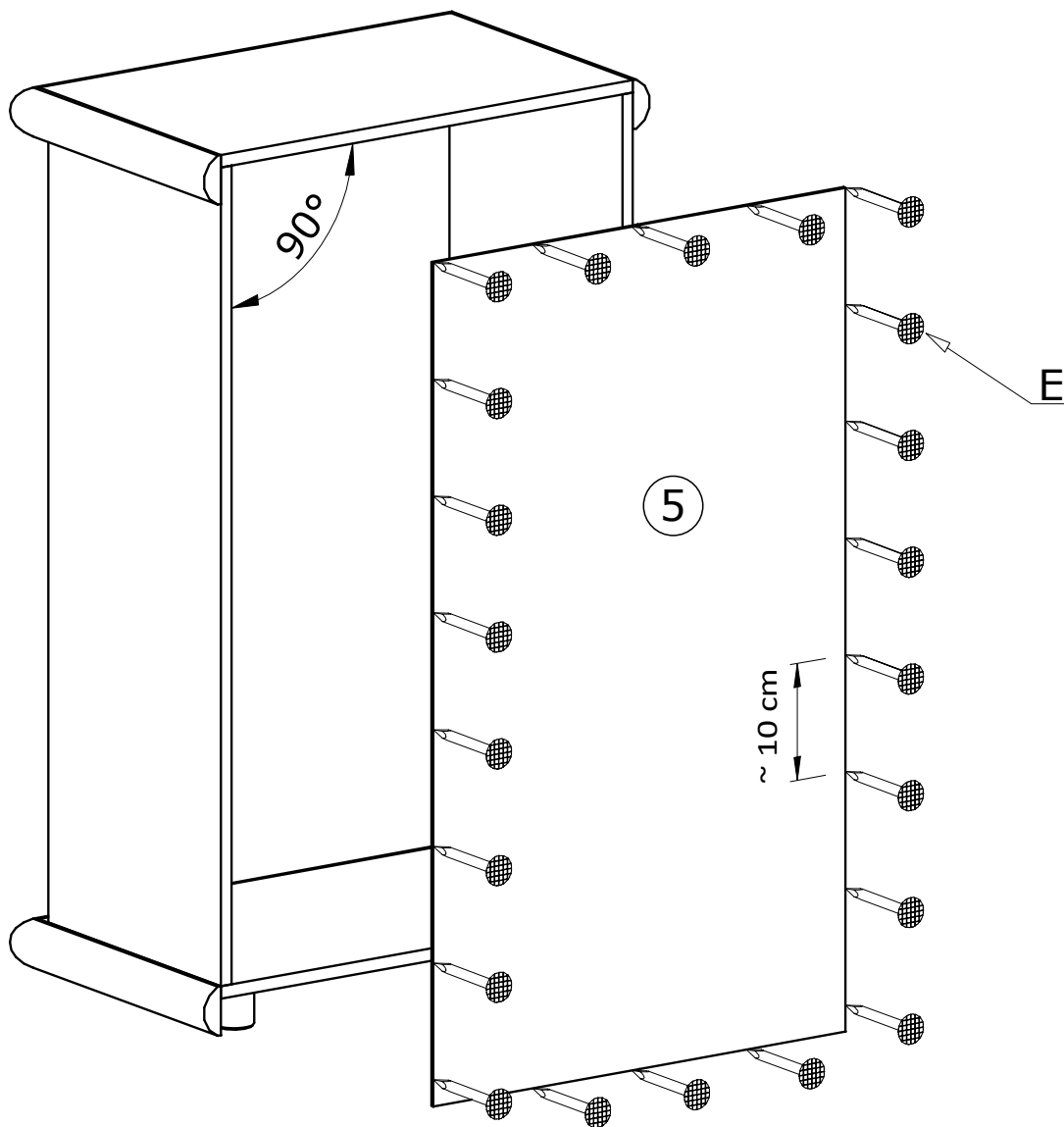

V

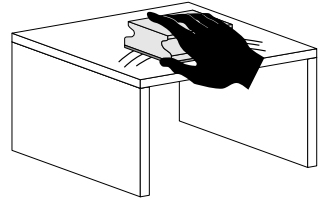
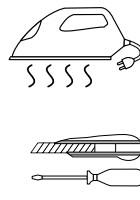
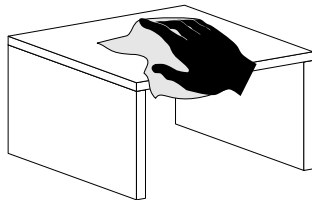
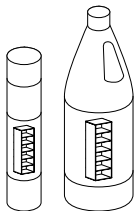
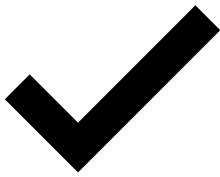
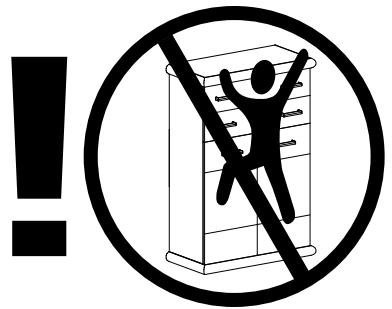
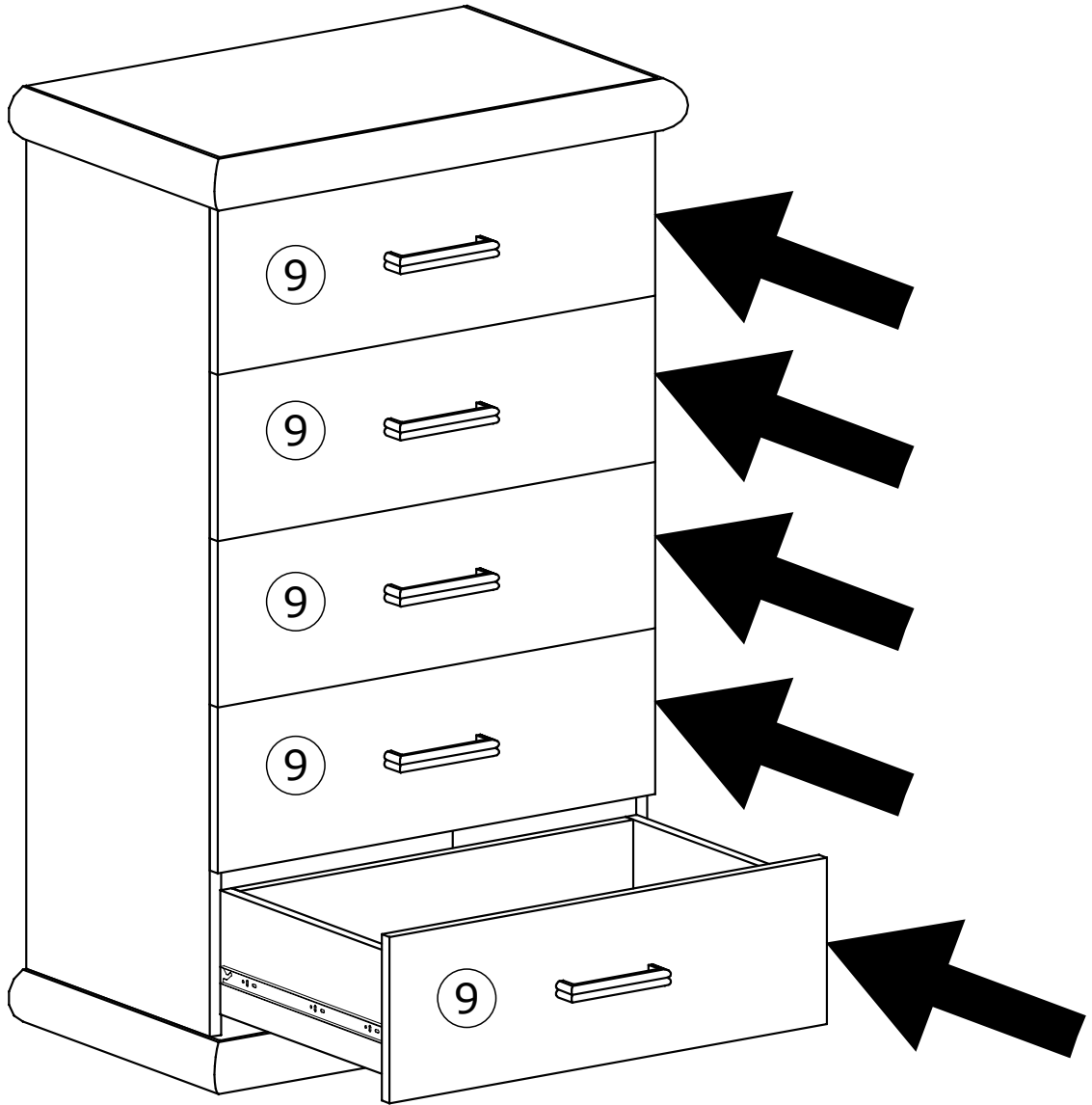

MONTAŻ/DEMONTAŻ PROWADNIC

1



2

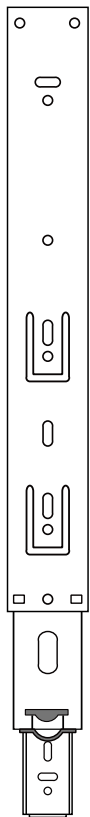

3

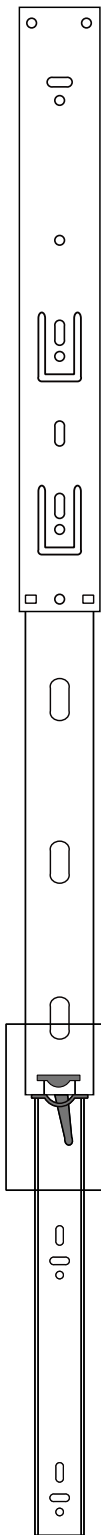

4

