

KORA 15

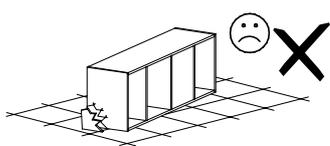

Narzędzia potrzebne do montażu

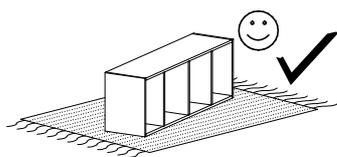
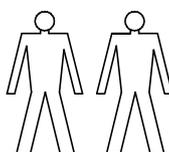
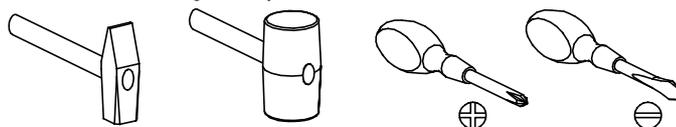

UWAGA !!!

MONTOWANIE USZKODZONYCH
ELEMENTÓW POWODUJE UTRATĘ
GWARANCJI

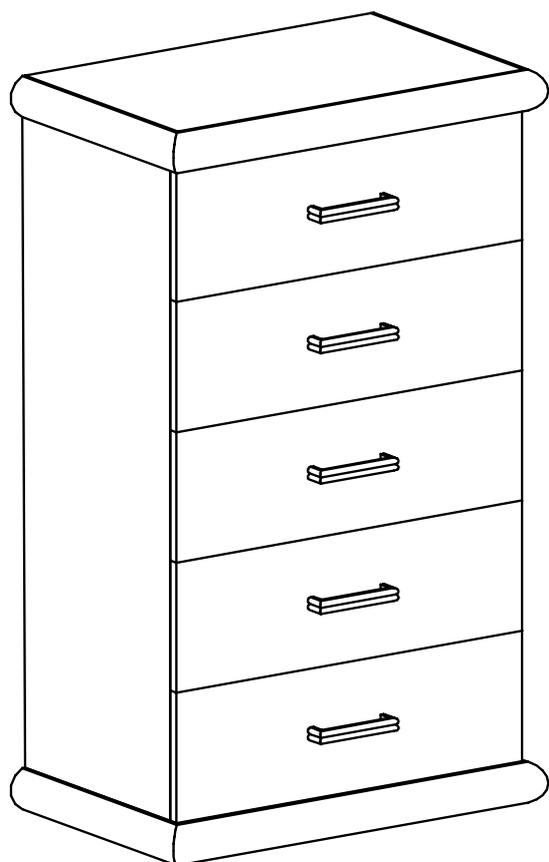

Nr	D[mm]	S[mm]	G[mm]	Ilość
1	700	450	65	1
2	700	450	65	1
3	1020	410	16	1
4	1020	410	16	1
5	1045	634	2,5	1
6	580	355	2,5	5
7	350	150	16	10
8	552	150	16	5
9	635	190	16	5

UWAGA !!!

Mebel zawiera
elementy drewniane

W przypadku reklamacji proszę podać numer pakowacza znajdujący się na kartonie.

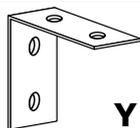

Y - 1 St.

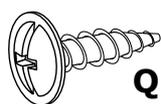

Q - 2 St.
3,5x16 mm



J - 40 St.
5x13 mm

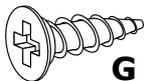

G - 16 St.
3,5x16 mm



X1 - 34 St.

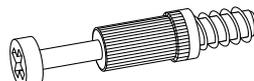

K - 18 St.



L - 18 St.



P - 20 St.
7x50 mm

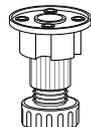

F - 4 St.



U - 5 St.

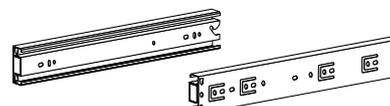

T - 5 Kpl.



E - 50 St.



B - 28 St.

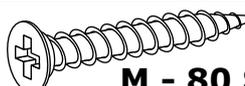

M - 80 St.
3x30 mm



Z - 1 St.

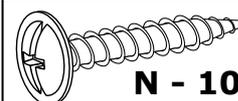

N - 10 St.
4x27 mm

I

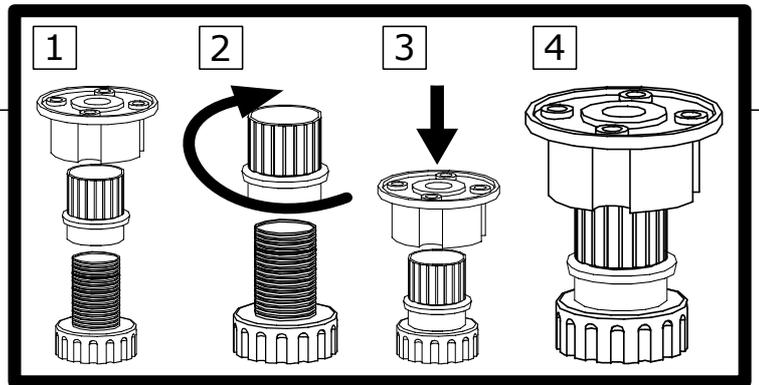
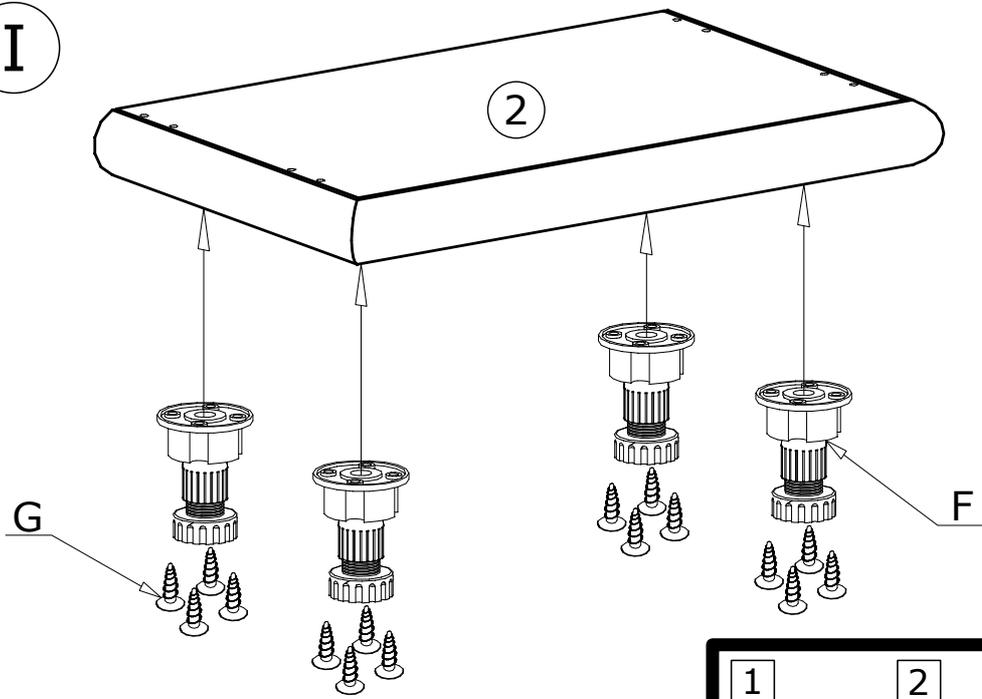

II

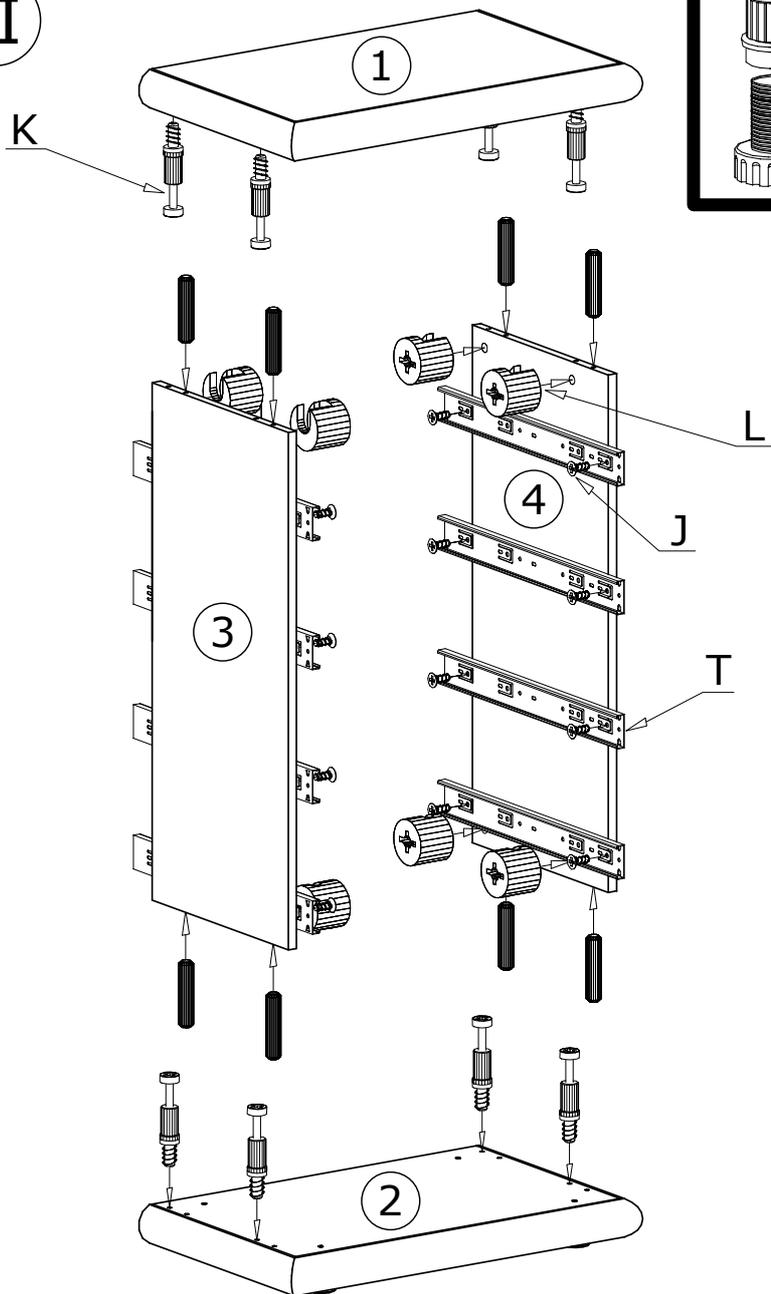

III

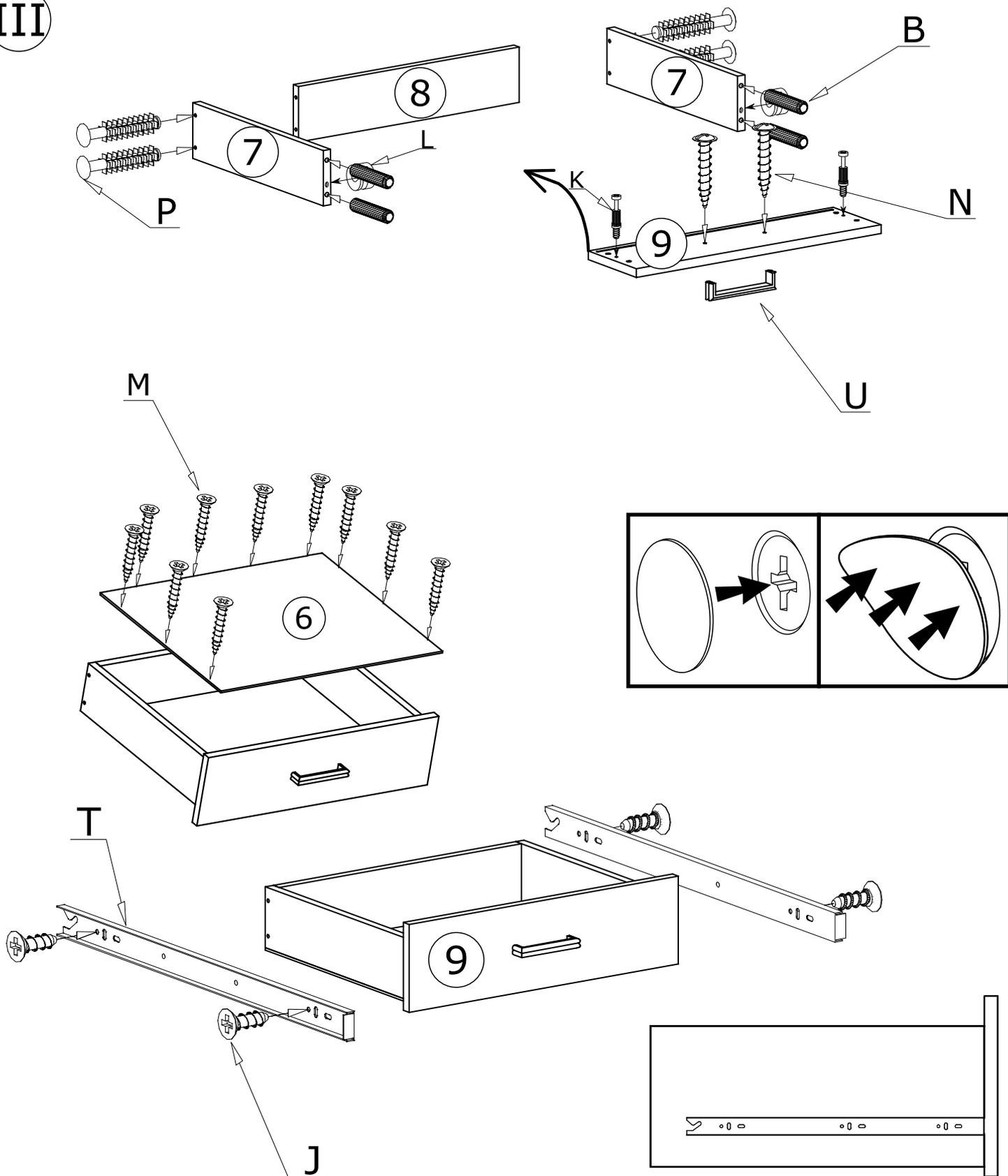

Meble zawierają elementy drewniane, których barwa i układ słojów są uzależnione od wielu czynników, dlatego mogą występować różnice w fakturze i barwie co nie stanowi wady produktu i nie wpływa na jego jakość, trwałość i funkcjonalność.

Listwy drewniane mogą ujawniać niewielkie zmiany w kształcie i wymiarach wywołane specyficznymi warunkami eksploatacji takimi jak: wilgotność, różnice temperatur, etc.

IV

50X 

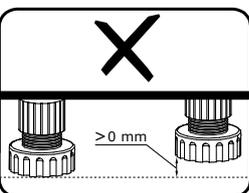
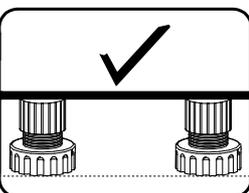
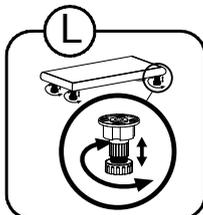
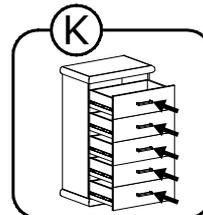
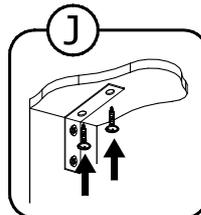
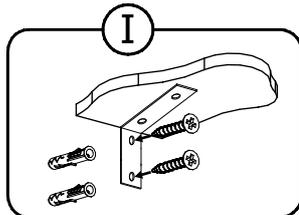
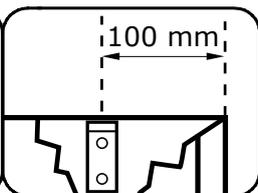
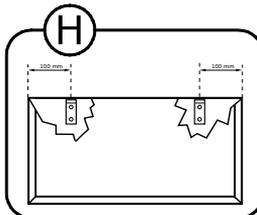
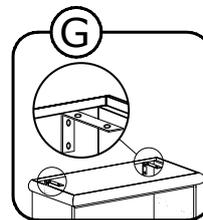
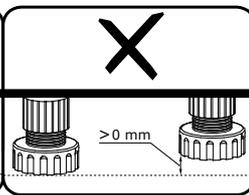
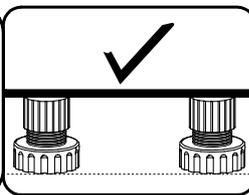
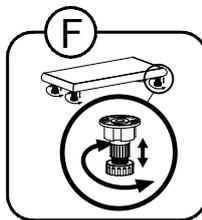
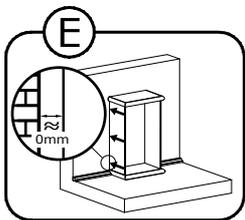
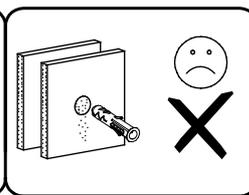
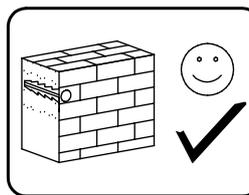
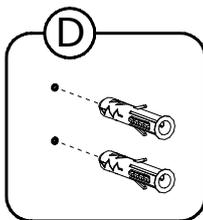
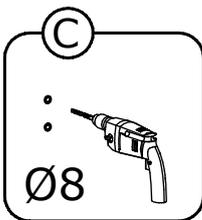
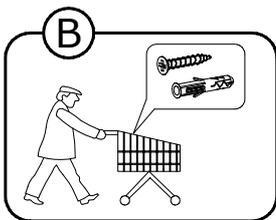
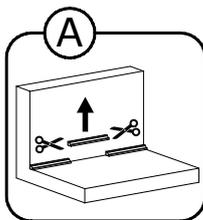
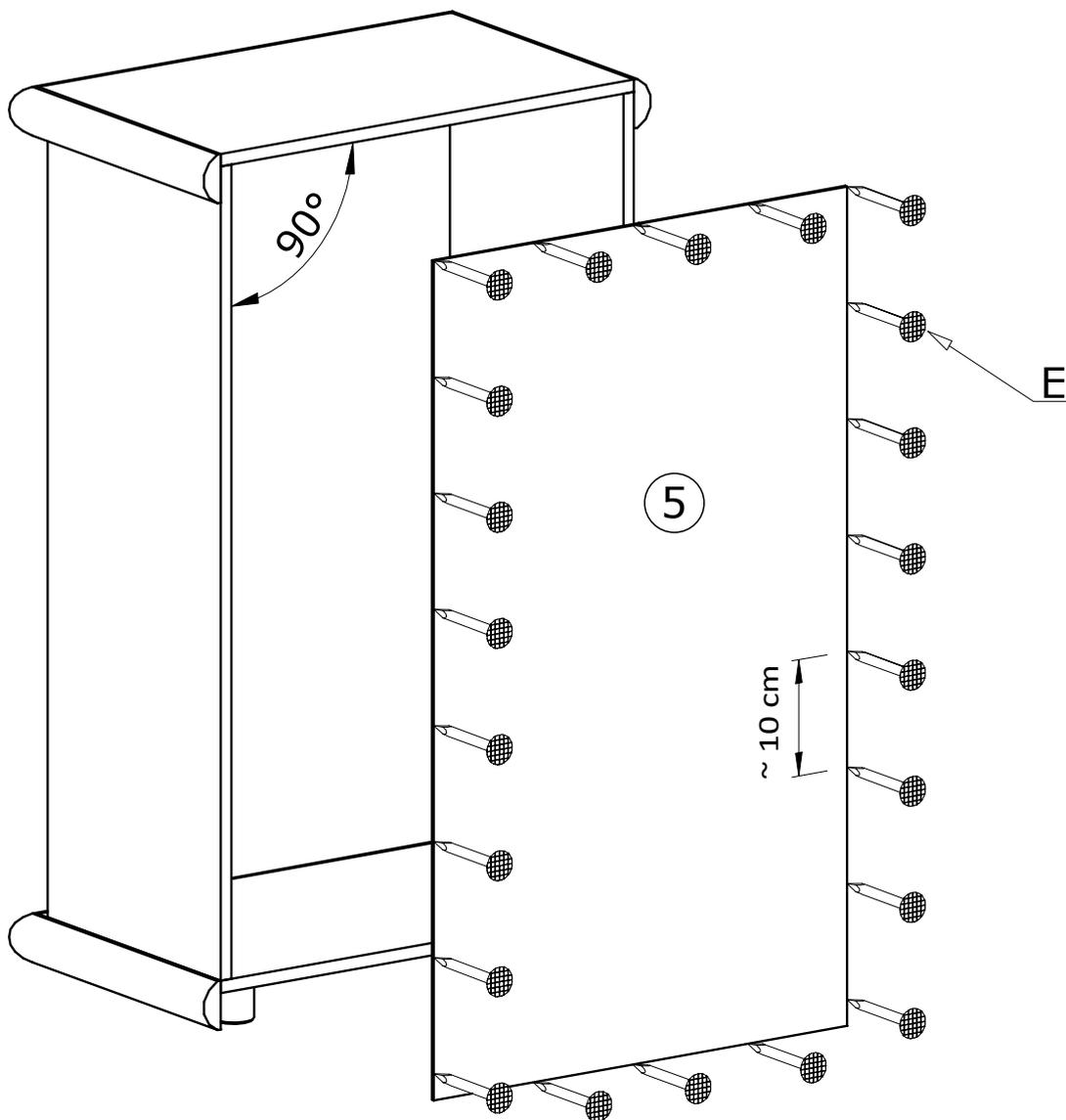

V

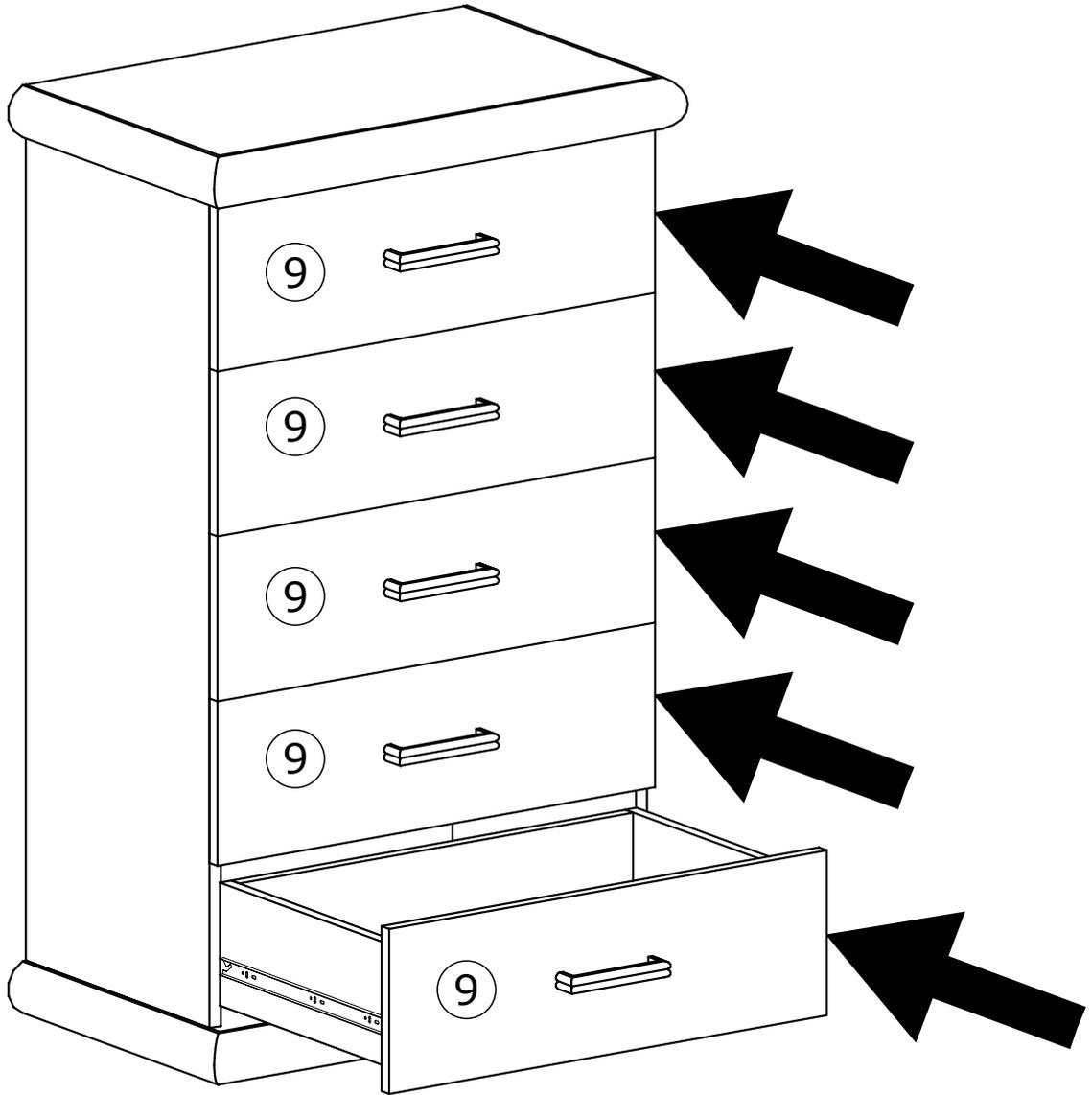

MONTAŻ/DEMONTAŻ PROWADNIC

1



2

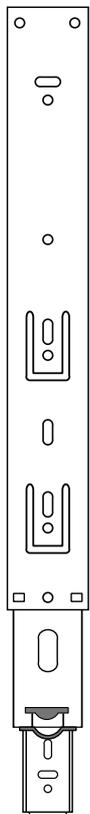

3

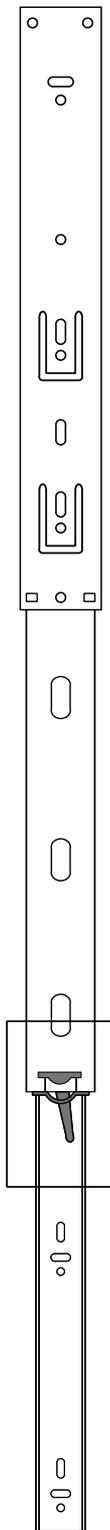

4

