

# KORA 5



Narzędzia potrzebne do montażu



## **UWAGA !!!**

MONTOWANIE USZKODZONYCH  
ELEMENTÓW POWODUJE UTRATĘ  
GWARANCJI

Nr	D[mm]	S[mm]	G[mm]	Ilość
1	870	450	65	1
2	870	450	65	1
3	1835	410	16	1
4	1835	410	16	1
5	777	410	16	1
6	777	380	16	3
7	1860	800	2,5	1
8	771	400	16	1
9	771	400	16	1

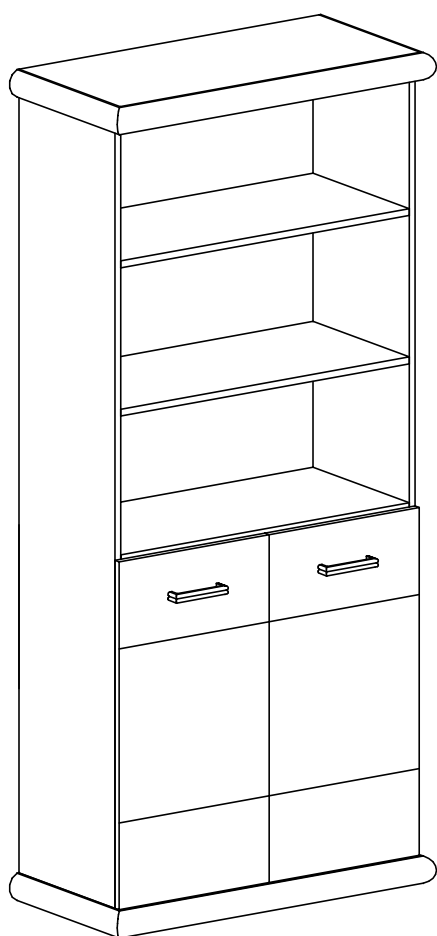

## **UWAGA !!!**

Mebel zawiera  
elementy drewniane

W przypadku reklamacji proszę podać numer pakowacza znajdujący się na kartonie.

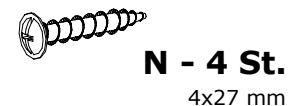
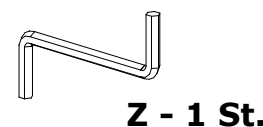
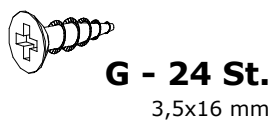
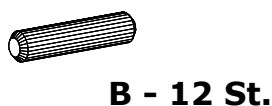
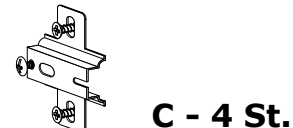
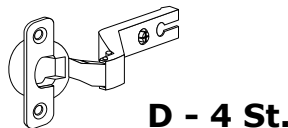
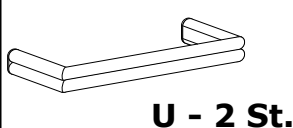
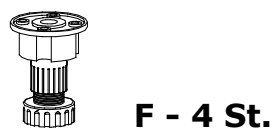
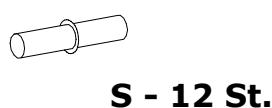
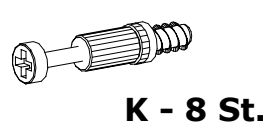
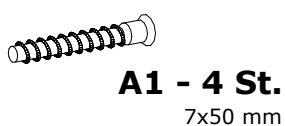
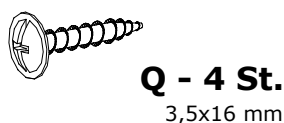
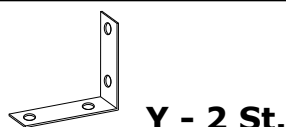

I

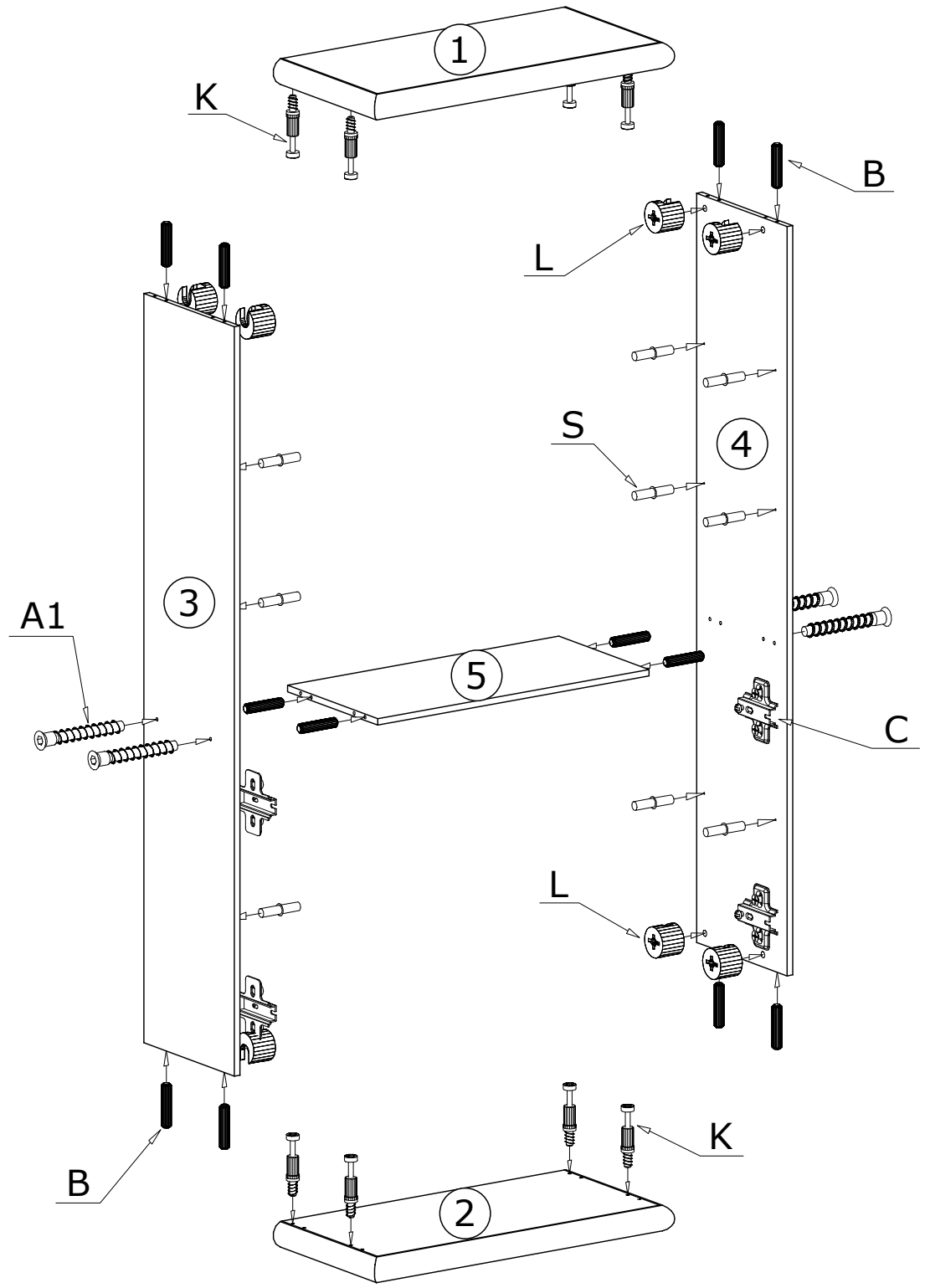
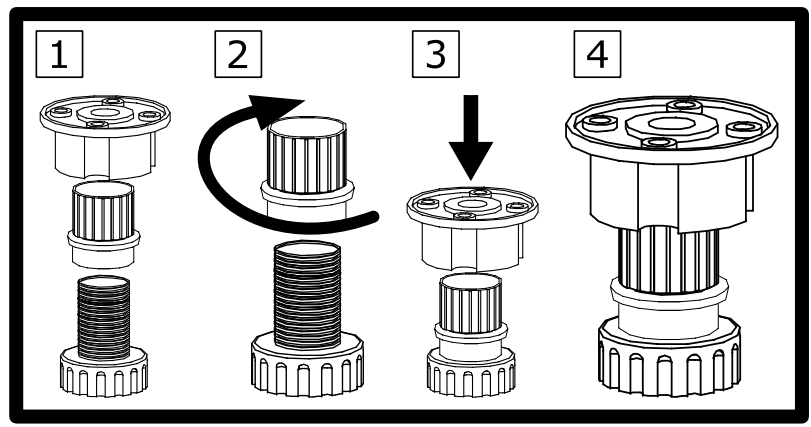
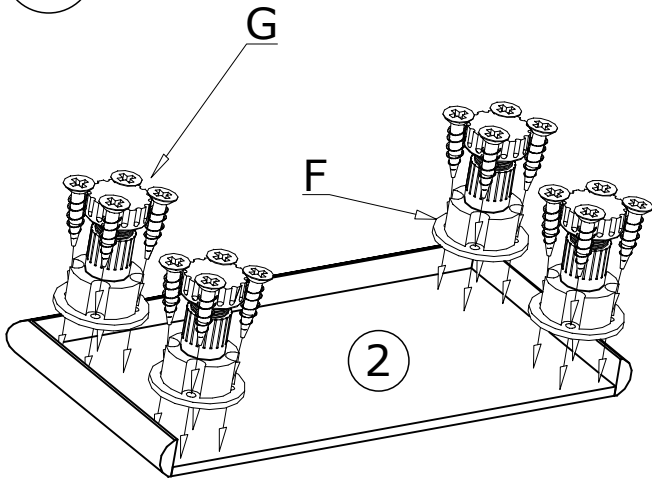

II

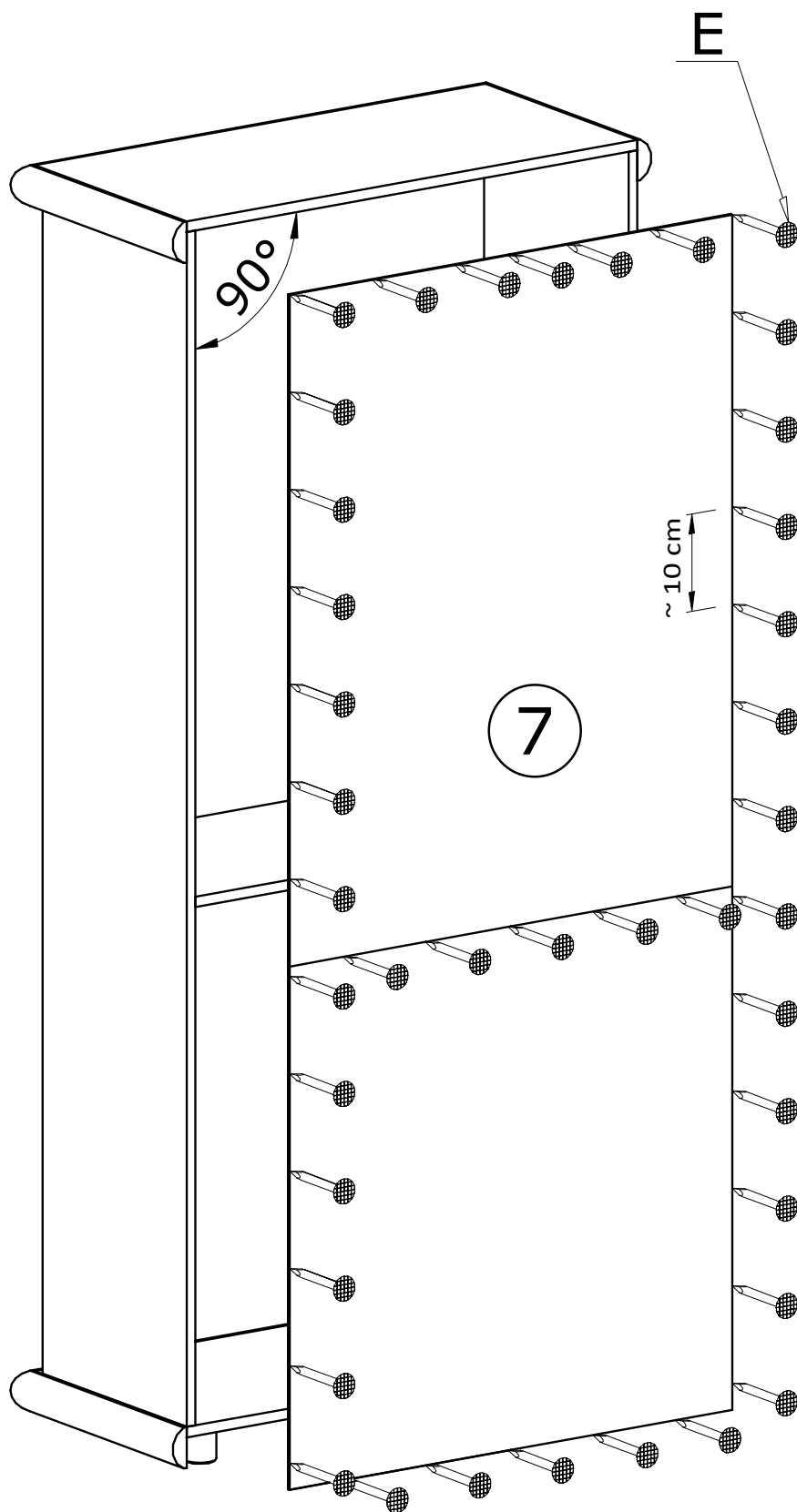

70X



Meble zawierają elementy drewniane, których barwa i układ słojów są uzależnione od wielu czynników, dlatego mogą występować różnice w fakturze i barwie co nie stanowi wady produktu i nie wpływa na jego jakość, trwałość i funkcjonalność.

Listwy drewniane mogą ujawniać niewielkie zmiany w kształcie i wymiarach wywołane specyficznymi warunkami eksploatacji takimi jak: wilgotność, różnice temperatur, etc.

# IV

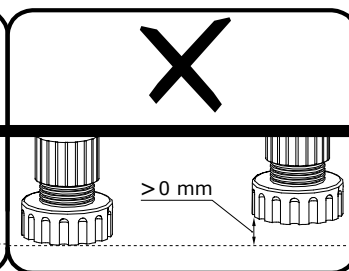
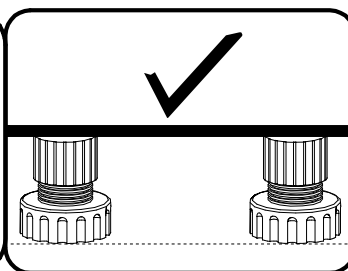
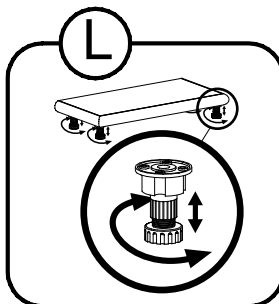
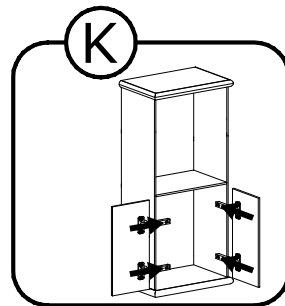
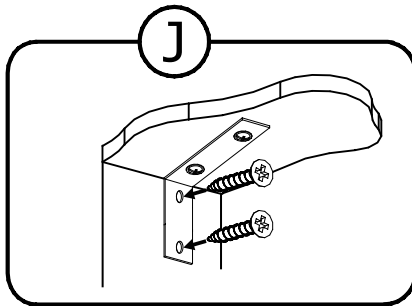
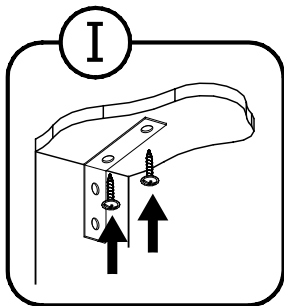
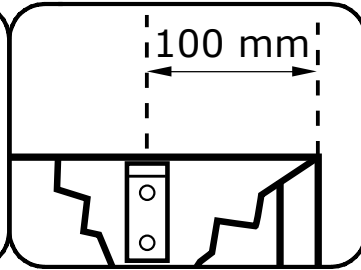
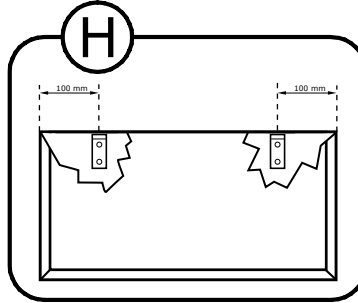
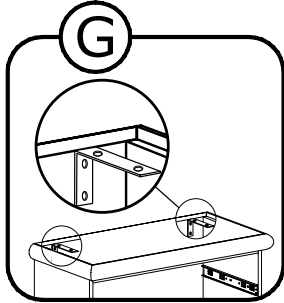
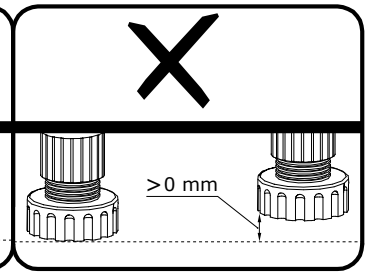
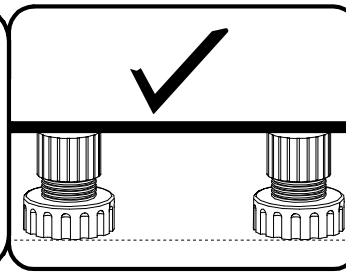
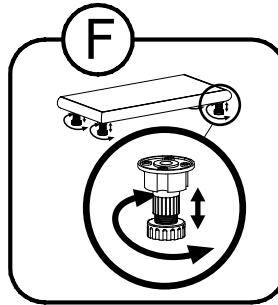
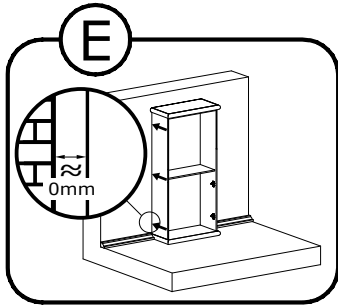
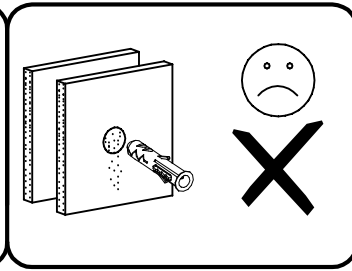
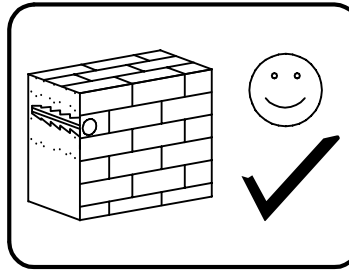
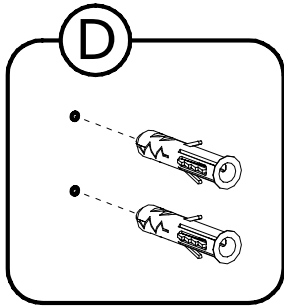
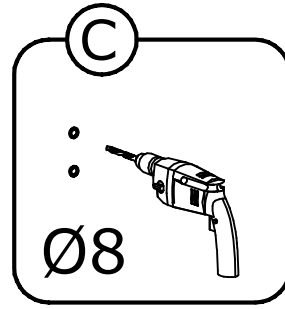
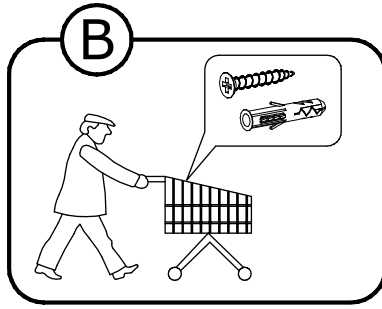
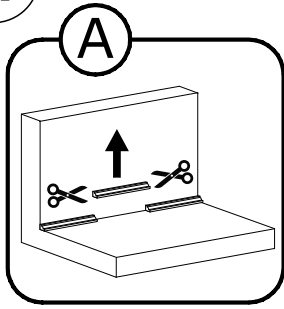

III

