

KORA 3

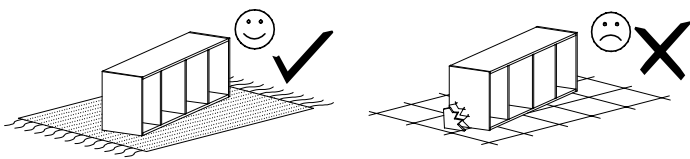

Narzędzia potrzebne do montażu

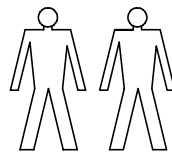
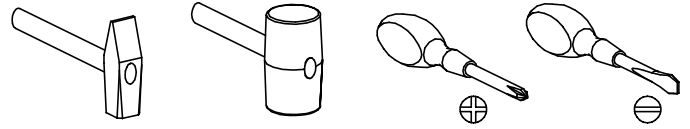

UWAGA !!!

MONTOWANIE USZKODZONYCH
ELEMENTÓW POWODUJE UTRATĘ
GWARANCJI

Nr	D[mm]	S[mm]	G[mm]	Ilość
1	870	450	65	1
2	870	450	65	1
3	1835	410	16	1
4	1835	410	16	1
5	777	410	16	1
6	777	380	16	3
7	1860	800	2,5	1
8	1005	400	16	1
9	1005	400	16	1
10	771	400	16	1
11	771	400	16	1

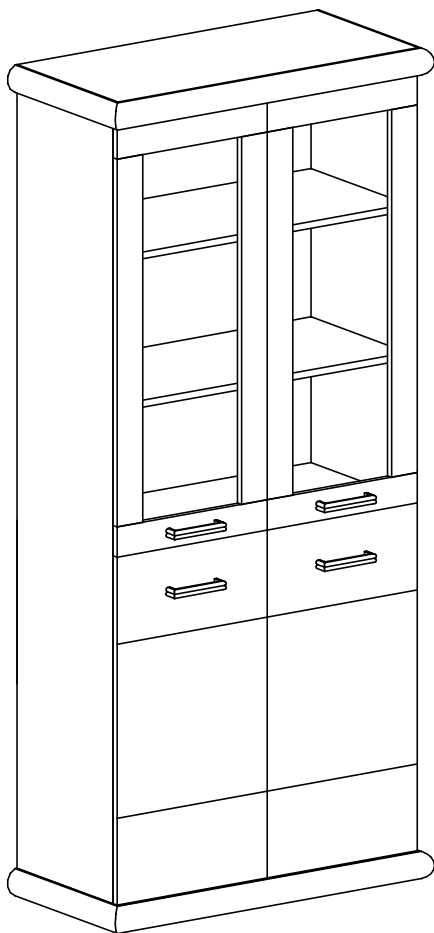

UWAGA !!!

Mebel zawiera
elementy drewniane

W przypadku reklamacji proszę podać numer pakowacza znajdujący się na kartonie.

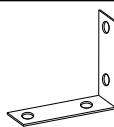

Y - 1 St.

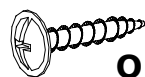

Q - 2 St.
3,5x16 mm



A1 - 4 St.
7x50 mm

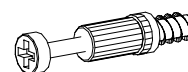

K - 8 St.



L - 8 St.

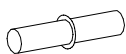

S - 12 St.

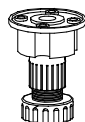

F - 4 St.



U - 4 St.

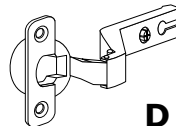

D - 8 St.

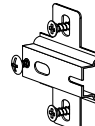

C - 8 St.



E - 70 St.



B - 12 St.



G - 32 St.
3,5x16 mm

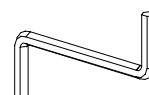

Z - 1 St.



N - 8 St.
4x27 mm

I

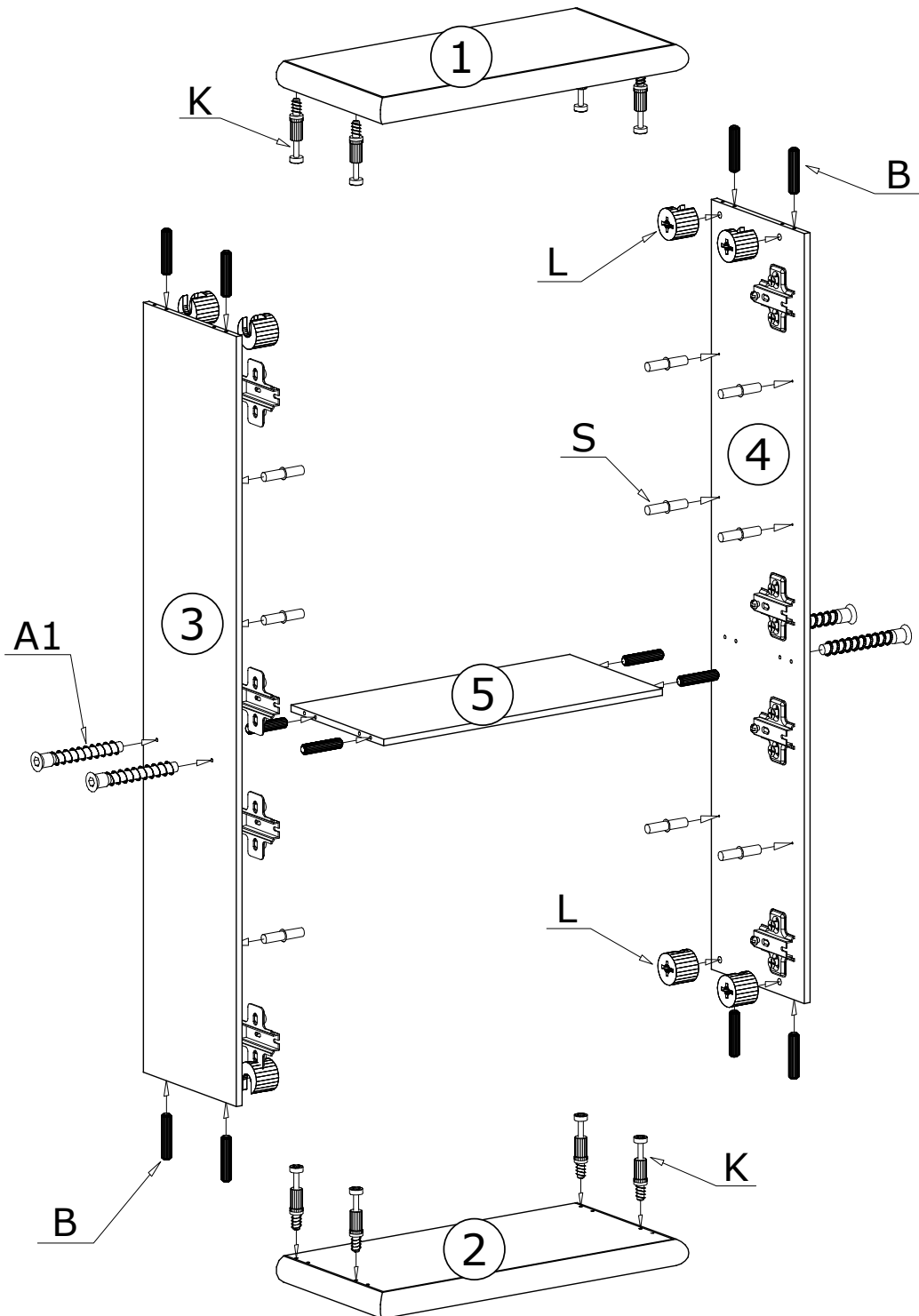
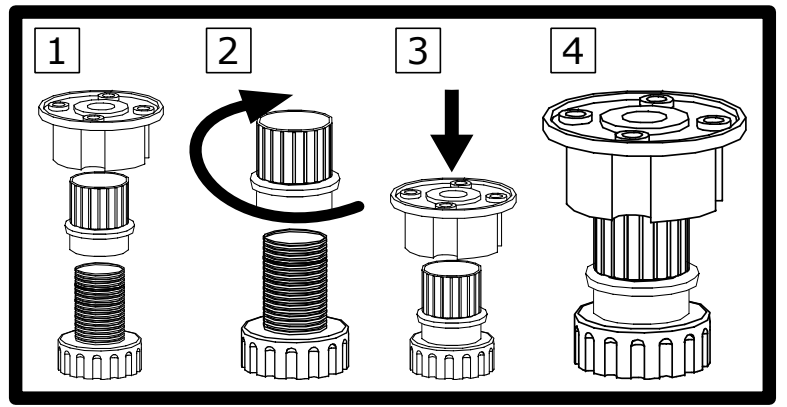
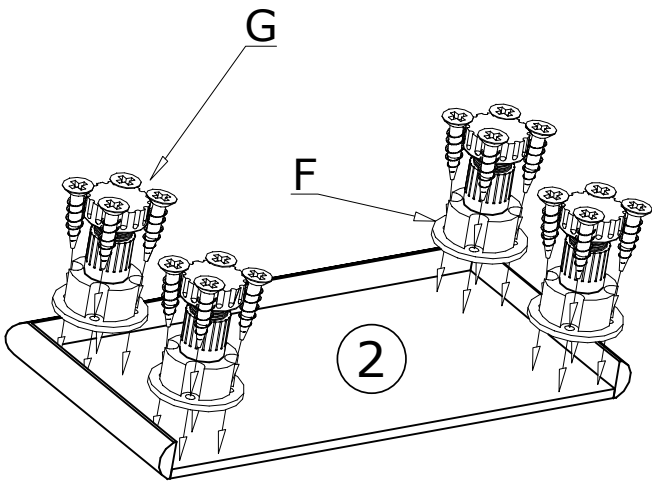

II

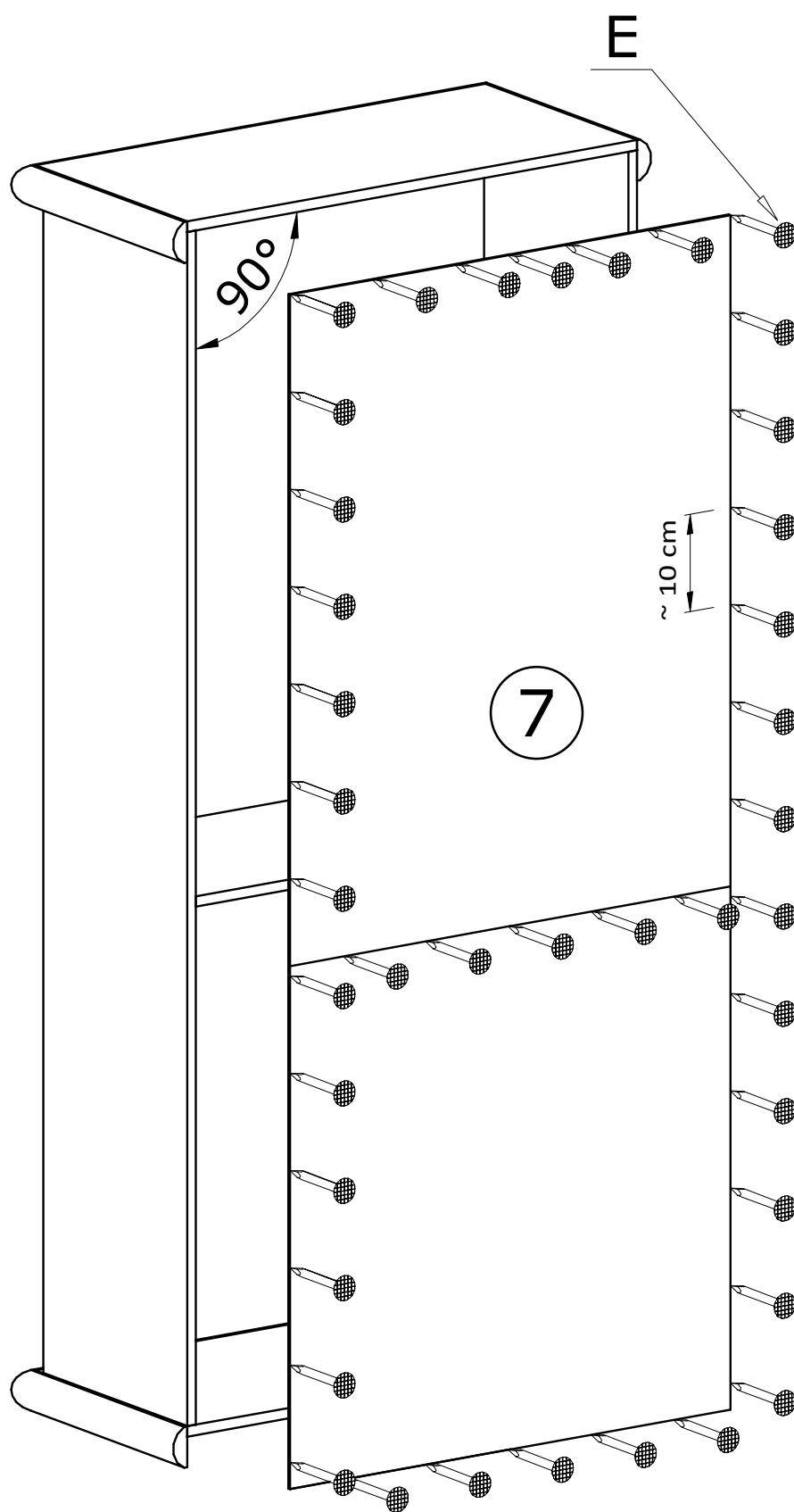
70X 

Meble zawierają elementy drewniane, których barwa i układ słojów są uzależnione od wielu czynników, dlatego mogą występować różnice w fakturze i barwie co nie stanowi wady produktu i nie wpływa na jego jakość, trwałość i funkcjonalność.

Listwy drewniane mogą ujawniać niewielkie zmiany w kształcie i wymiarach wywołane specyficznymi warunkami eksploatacji takimi jak: wilgotność, różnice temperatur, etc.

IV

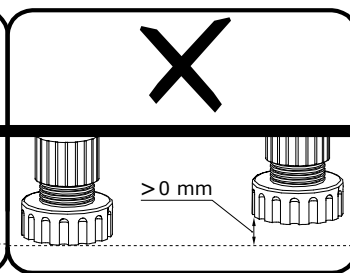
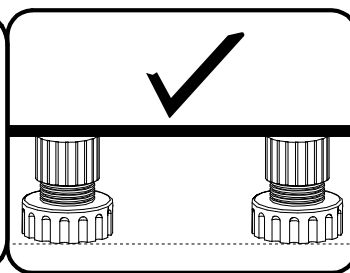
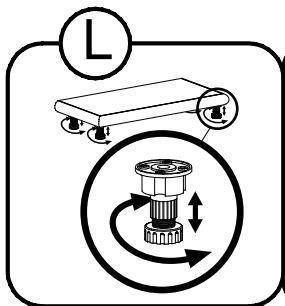
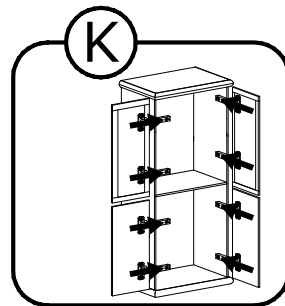
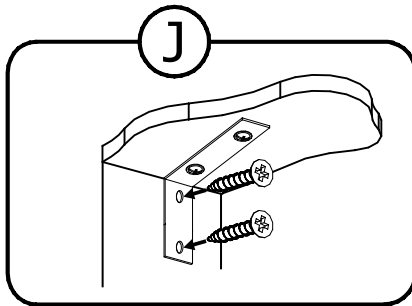
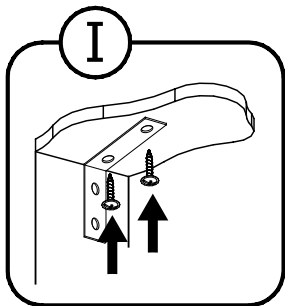
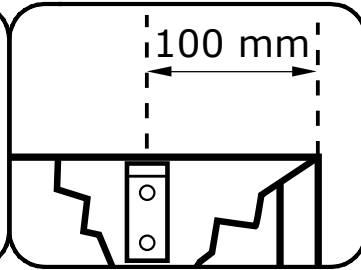
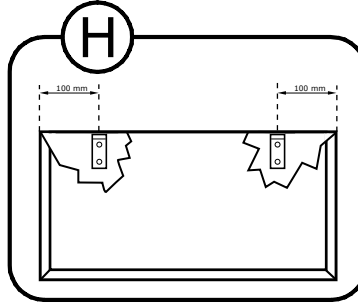
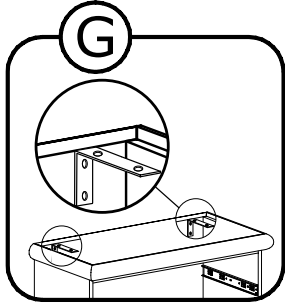
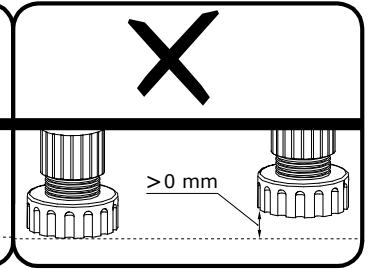
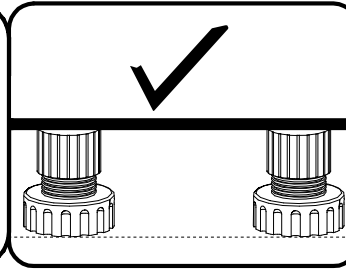
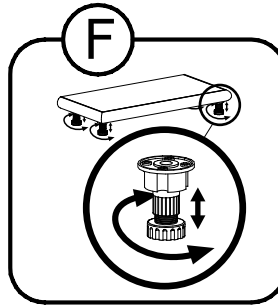
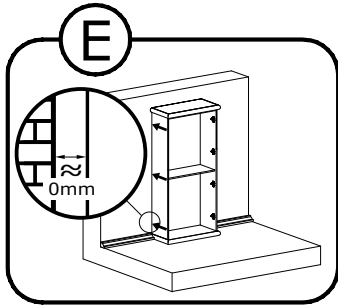
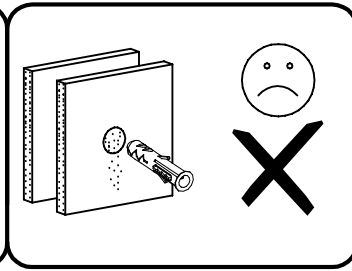
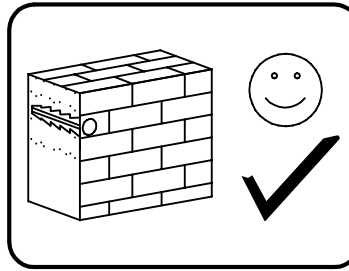
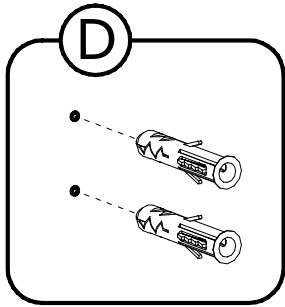
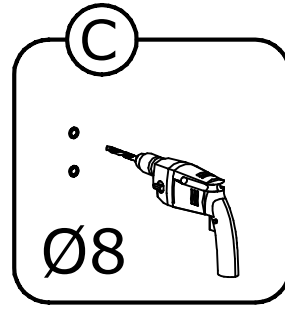
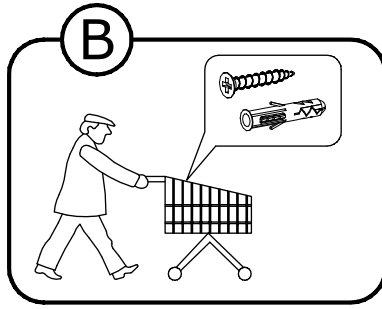
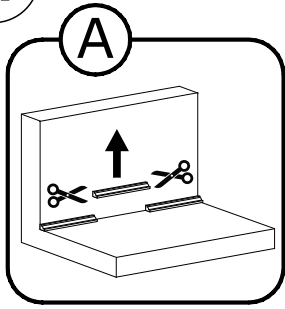

III

