

# KORA 2

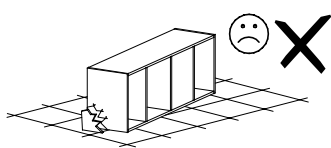

Narzędzia potrzebne do montażu

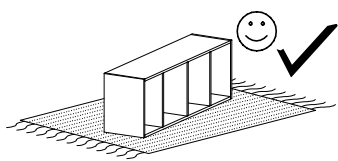

## **UWAGA !!!**

MONTOWANIE USZKODZONYCH  
ELEMENTÓW POWODUJE UTRATĘ  
GWARANCJI

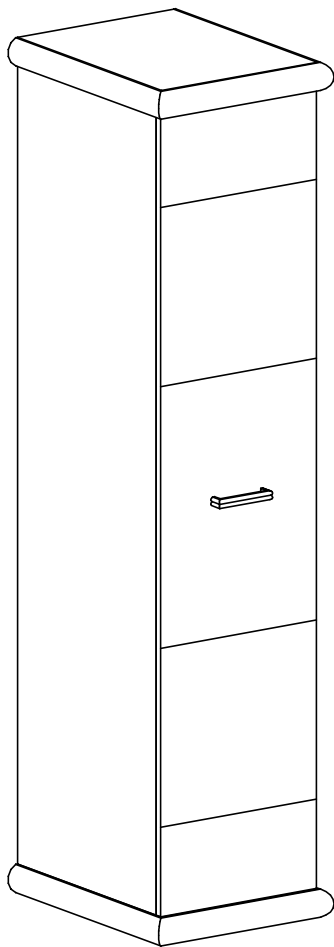

Nr	D[mm]	S[mm]	G[mm]	Ilość
1	465	565	65	1
2	465	565	65	1
3	1835	523	16	1
4	1835	523	16	1
5	373	523	16	1
6	1782	400	16	1
7	1860	396	2,5	1

## **UWAGA !!!**

Mebel zawiera  
elementy drewniane

W przypadku reklamacji proszę podać numer pakowacza znajdujący się na kartonie.

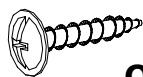

**Q - 4 St.**  
3,5x16 mm

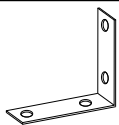

**I - 2 St.**

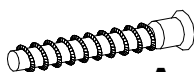

**A - 4 St.**  
7x40 mm

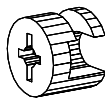

**L - 12 St.**

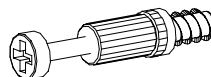

**K - 12 St.**



**R - 1 St.**  
366 mm

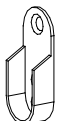

**Y - 2 St.**

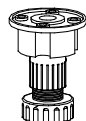

**F - 4 St.**



**U - 1 St.**

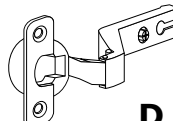

**D - 4 St.**

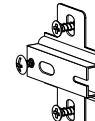

**C - 4 St.**

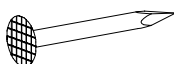

**E - 50 St.**



**B - 12 St.**



**G - 28 St.**  
3,5x16 mm

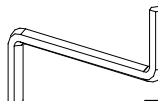

**Z - 1 St.**

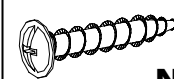

**N - 2 St.**  
4x27 mm

I

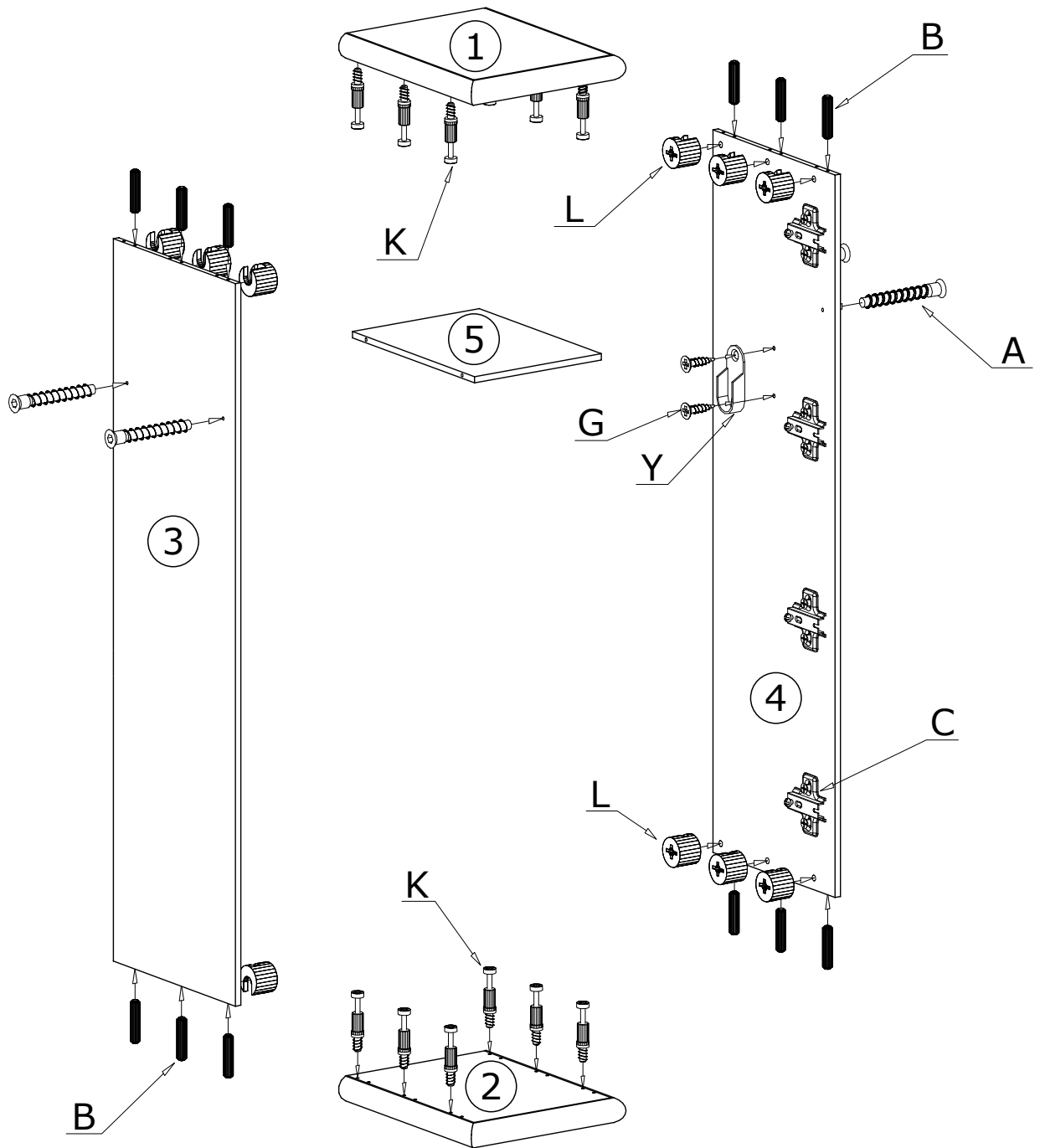
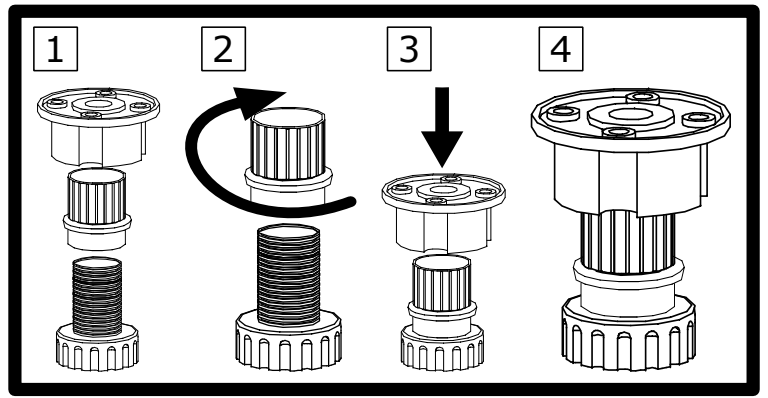
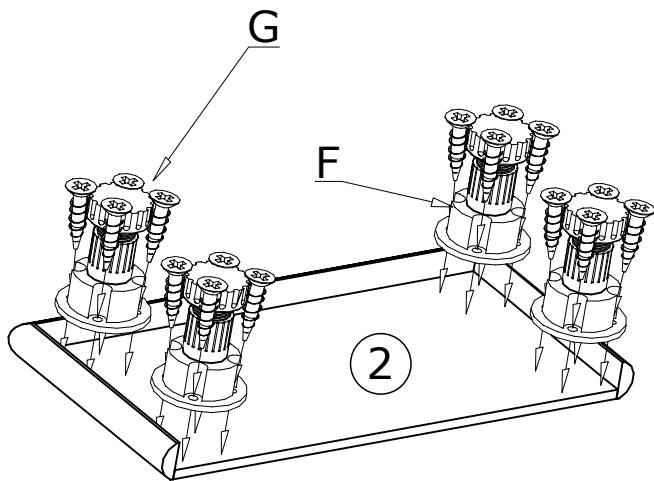

II

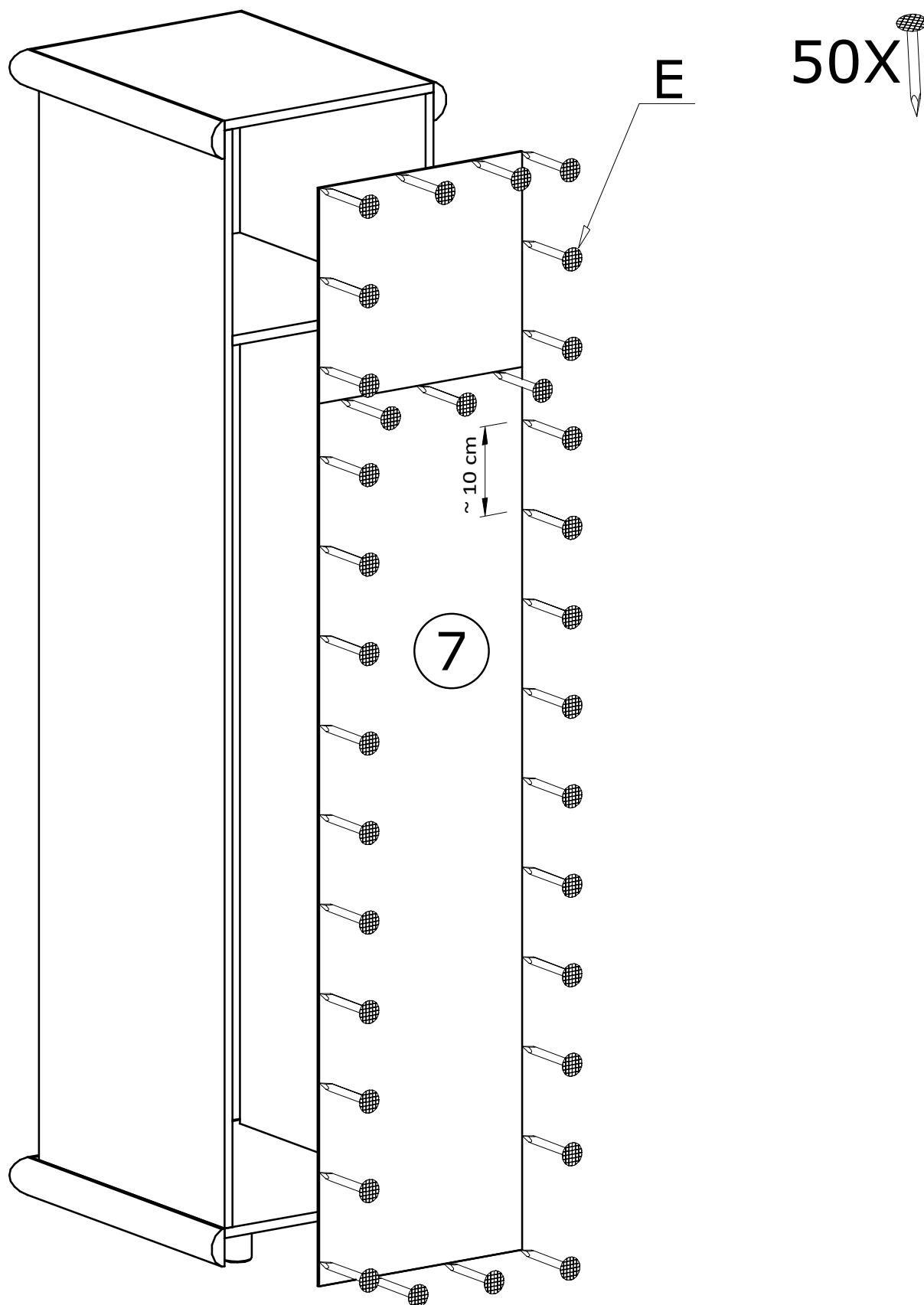

Meble zawierają elementy drewniane, których barwa i układ słoików są uzależnione od wielu czynników, dlatego mogą występować różnice w fakturze i barwie co nie stanowi wady produktu i nie wpływa na jego jakość, trwałość i funkcjonalność.

Listwy drewniane mogą ujawniać niewielkie zmiany w kształcie i wymiarach wywołane specyficznymi warunkami eksploatacji takimi jak: wilgotność, różnice temperatur, etc.

# IV

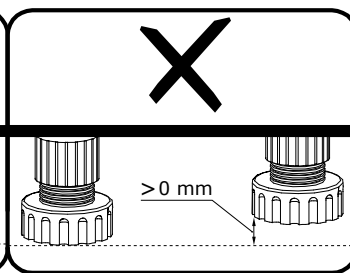
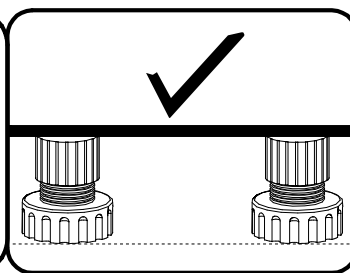
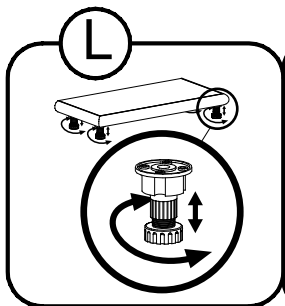
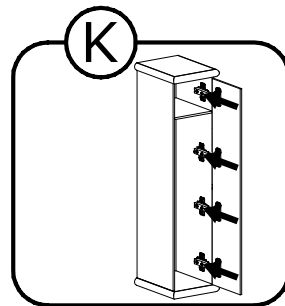
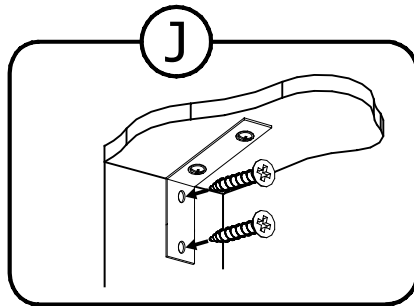
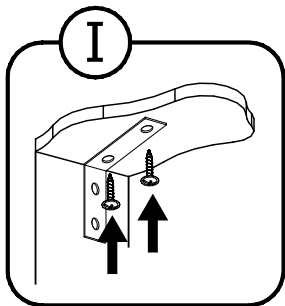
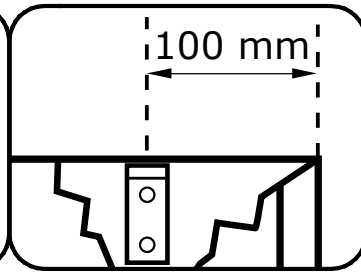
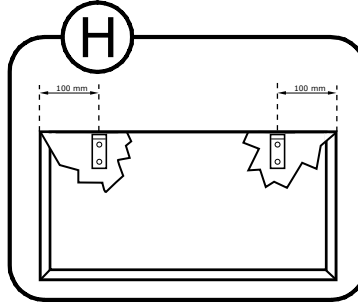
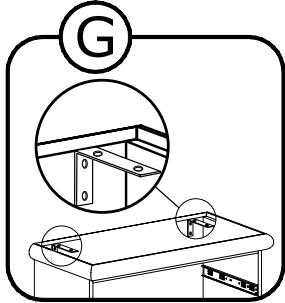
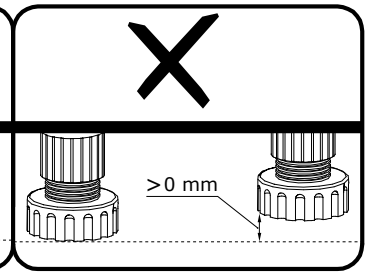
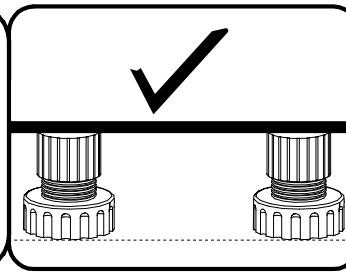
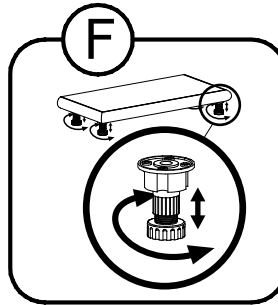
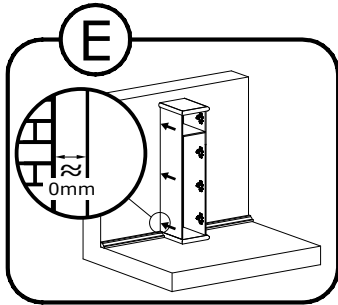
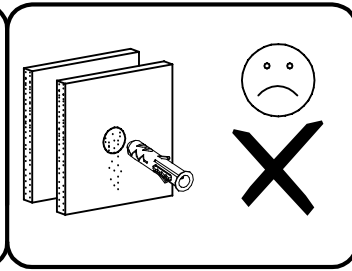
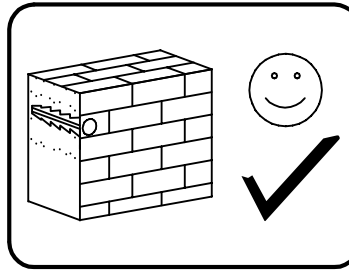
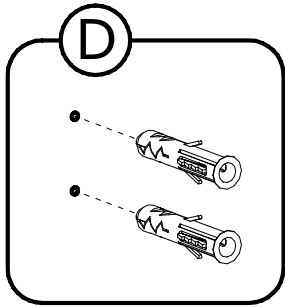
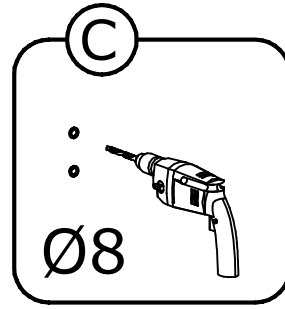
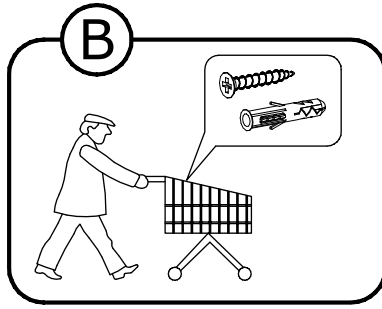
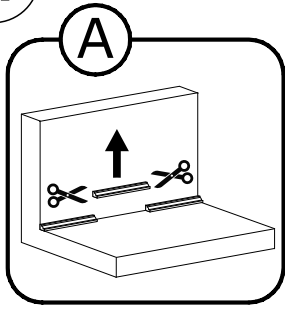

III

