

INDIANAPOLIS 5

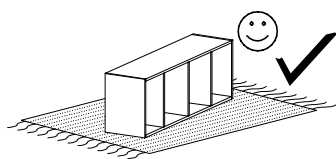

Narzędzia potrzebne do montażu



UWAGA !!!

MONTOWANIE USZKODZONYCH
ELEMENTÓW POWODUJE UTRATĘ
GWARANCJI

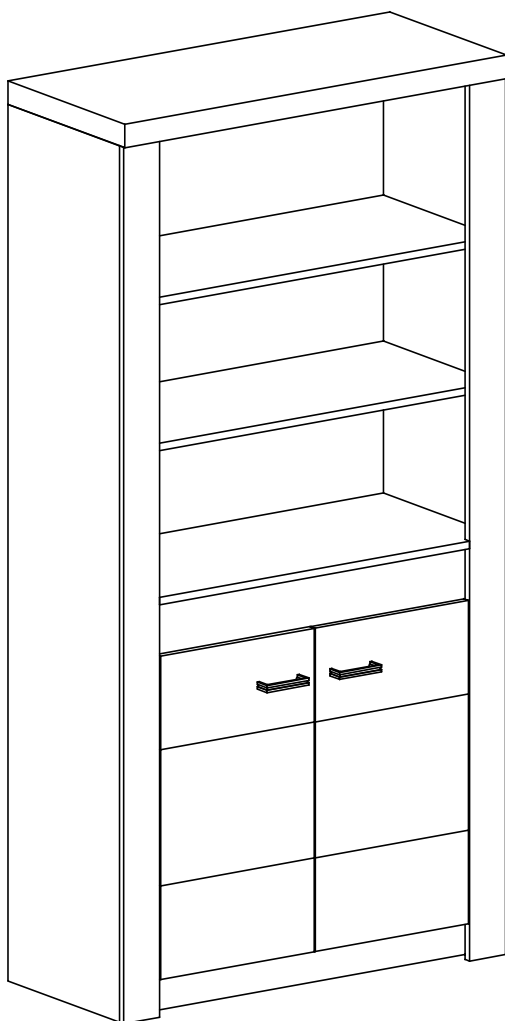

| Nr | D[mm] | S[mm] | G[mm] | Ilość |
|----|-------|-------|-------|-------|
| 1 | 927 | 422 | 16 | 1 |
| 2 | 1870 | 403 | 16 | 1 |
| 3 | 1870 | 403 | 16 | 1 |
| 4 | 927 | 403 | 16 | 1 |
| 5 | 927 | 80 | 16 | 1 |
| 6 | 927 | 123 | 16 | 1 |
| 7 | 1800 | 950 | 2,5 | 1 |
| 8 | 927 | 380 | 16 | 3 |
| 9 | 1870 | 80 | 16 | 1 |
| 10 | 1870 | 80 | 16 | 1 |
| 11 | 960 | 422 | 48 | 1 |
| 12 | 665 | 395 | 16 | 1 |
| 13 | 665 | 395 | 16 | 1 |

UWAGA !!!

Mebel zawiera
elementy drewniane

W przypadku reklamacji proszę podać numer pakowacza znajdujący się na kartonie.

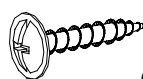

Q - 4 St.
3,5x16 mm

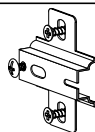

C - 4 St.

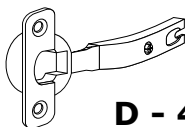

D - 4 St.

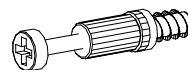

K - 12 St.

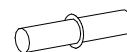

P - 12 St.

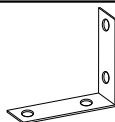

Y - 2 St.



S - 6 St.



U - 2 St.

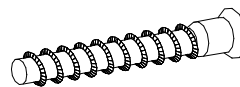

A - 8 St.

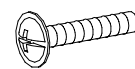

N - 4 St.
4x25 mm



E - 50 St.



B - 24 St.



G - 8 St.
3,5x16 mm

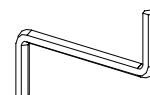

Z - 1 St.



L - 12 St.

I

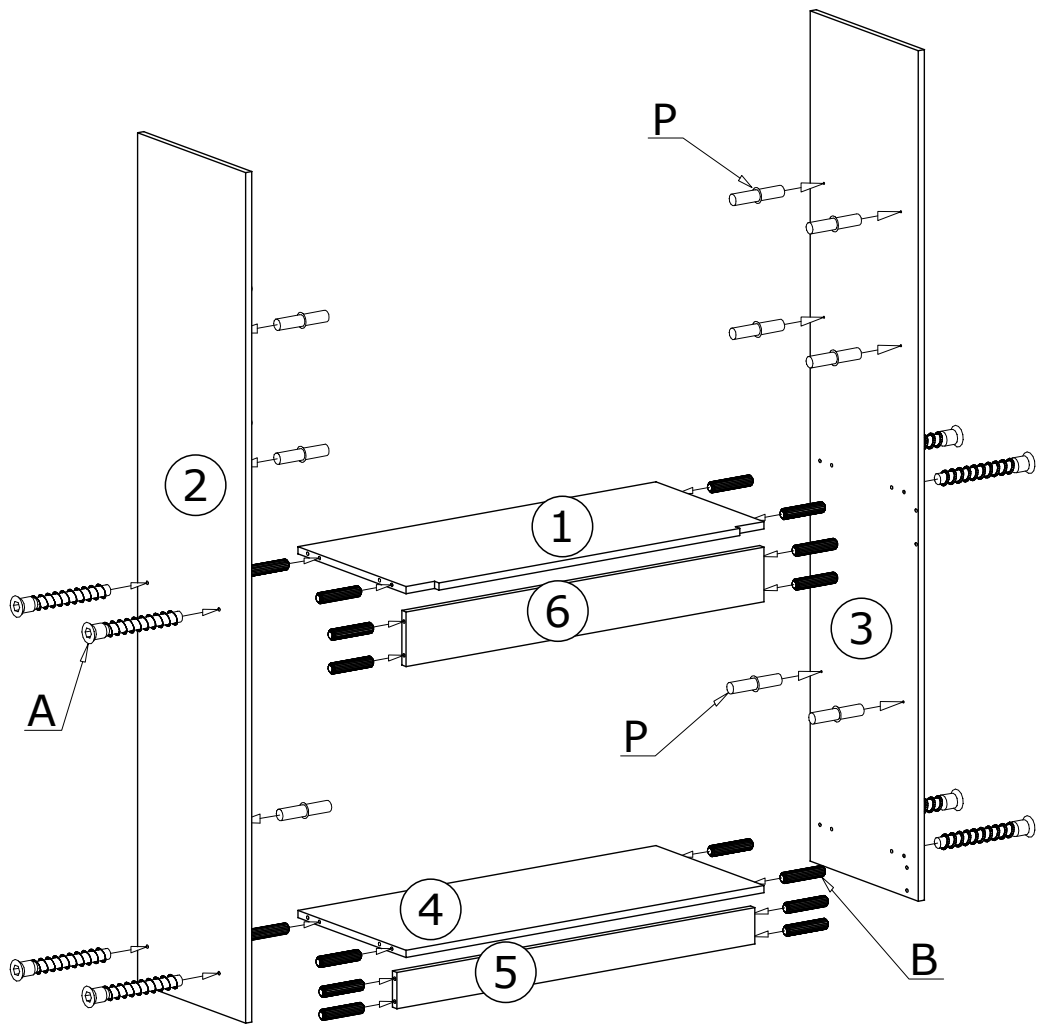

II

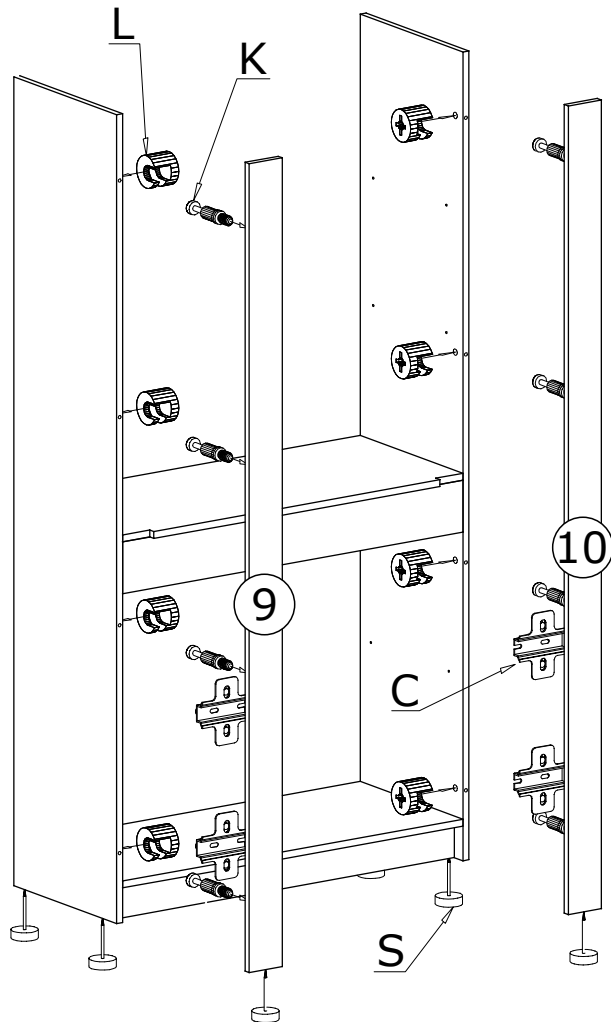

III

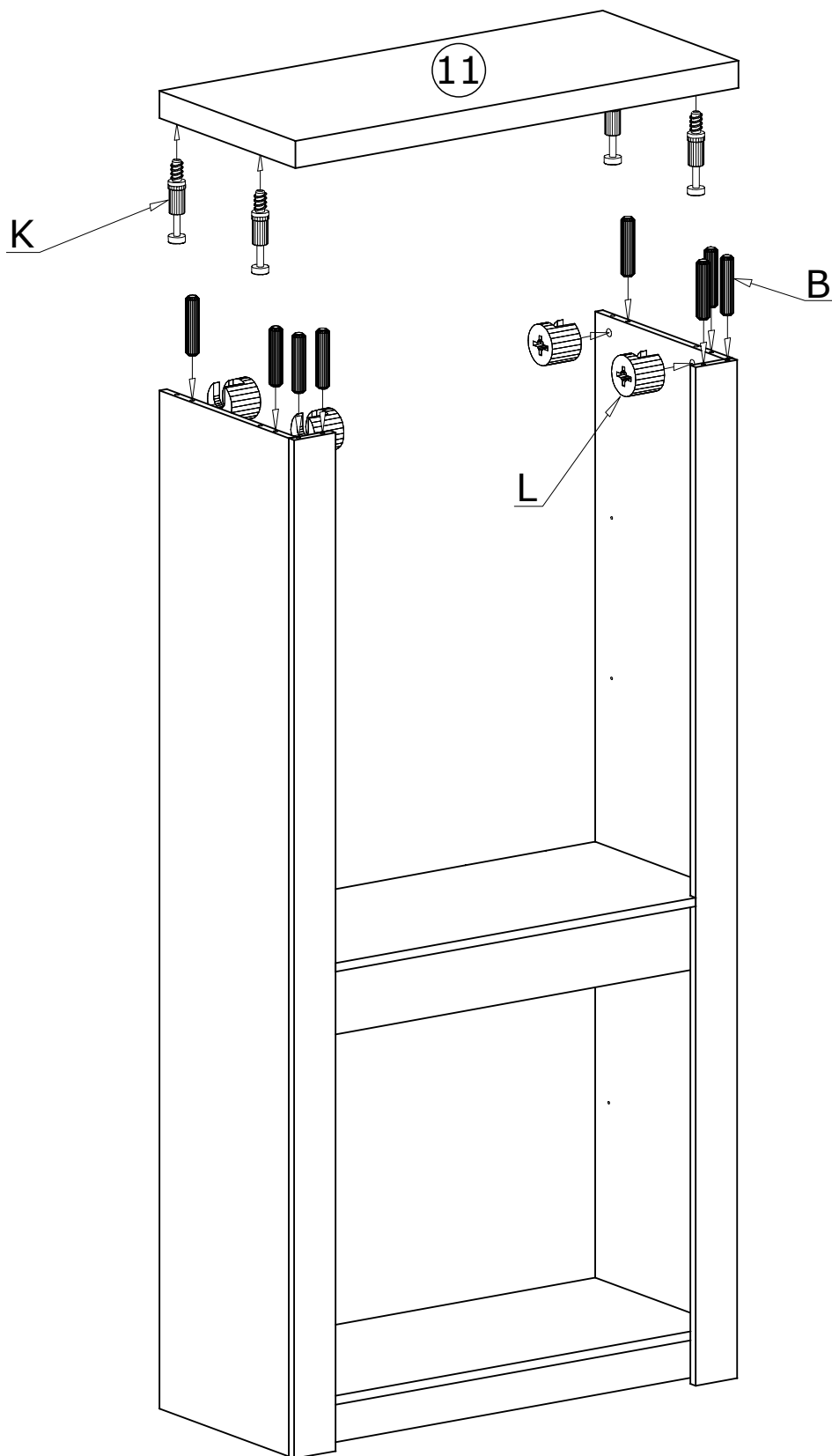

Meble zawierają elementy drewniane, których barwa i układ słoju są uzależnione od wielu czynników, dlatego mogą występować różnice w fakturze i barwie co nie stanowi wady produktu i nie wpływa na jego jakość, trwałość i funkcjonalność.

Listwy drewniane mogą ujawniać niewielkie zmiany w kształcie i wymiarach wywołane specyficznymi warunkami eksploatacji takimi jak: wilgotność, różnice temperatur, etc.

IV

50X 

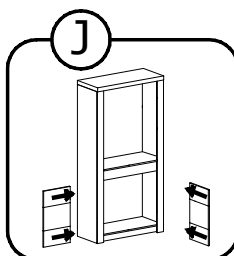
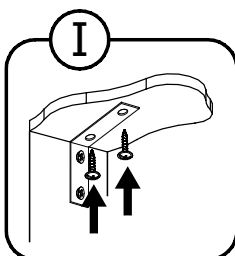
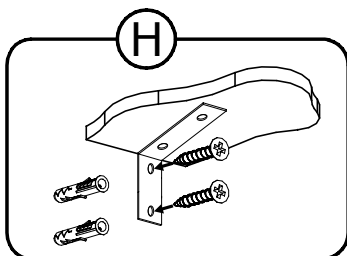
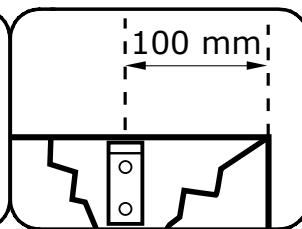
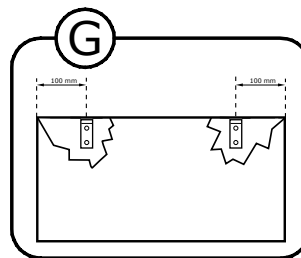
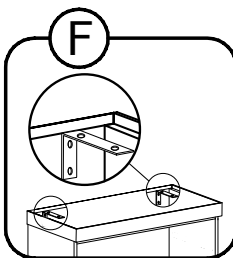
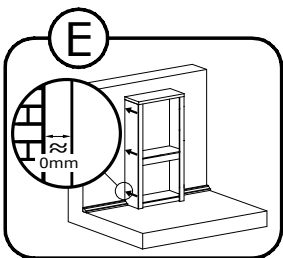
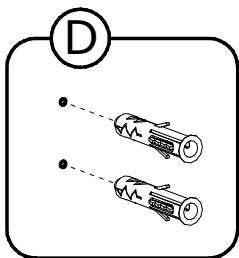
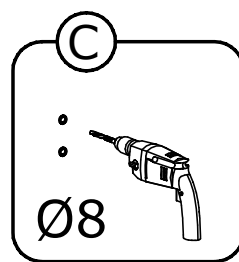
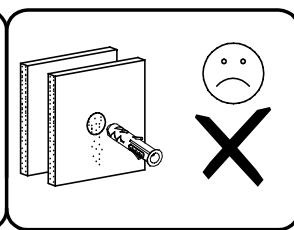
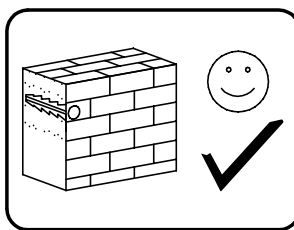
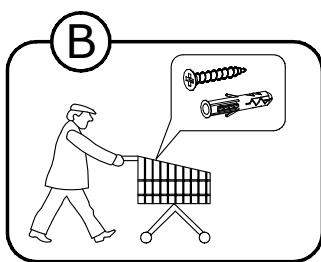
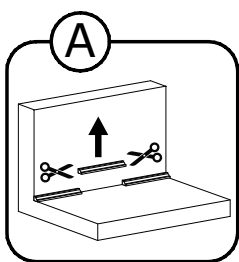
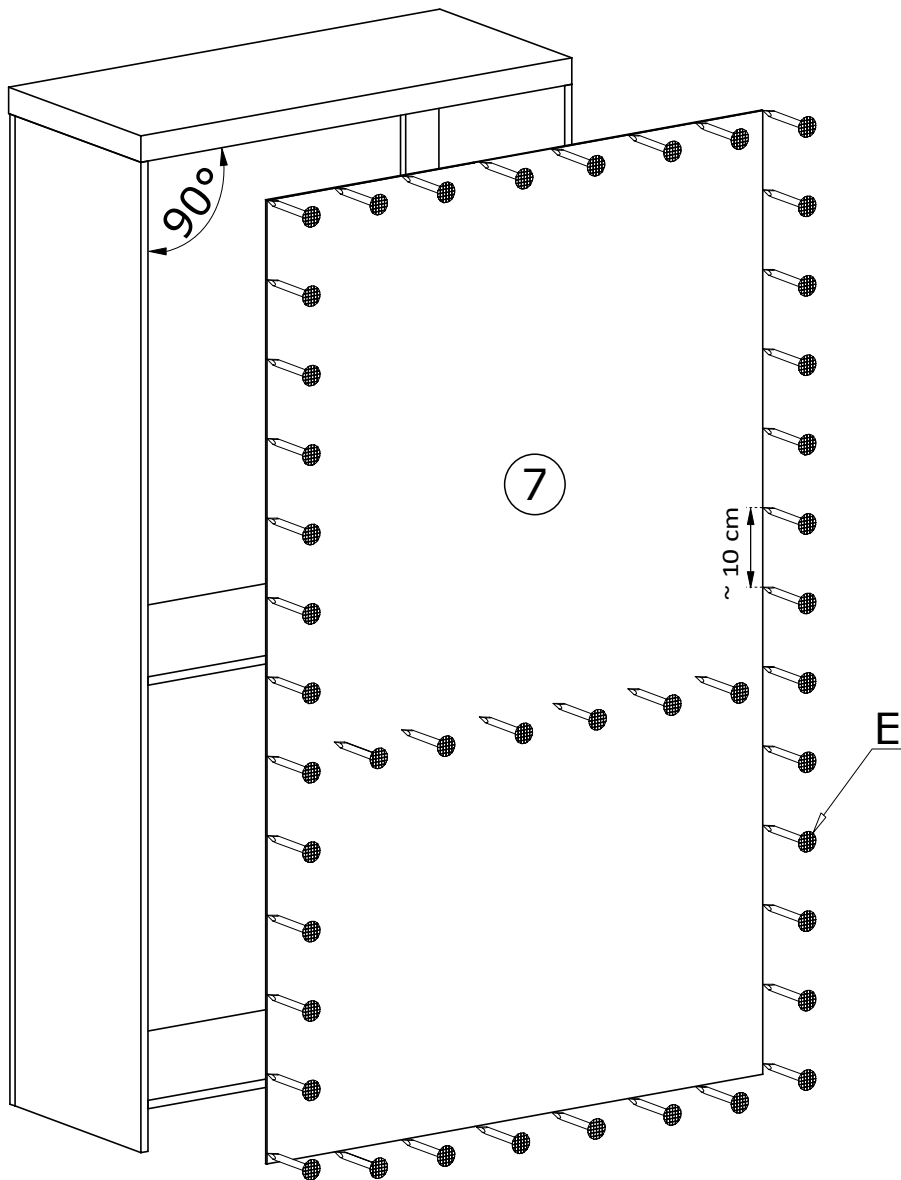

V

