

# INDIANAPOLIS 23

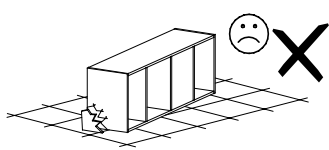

Narzędzia potrzebne do montażu

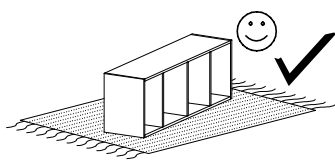

## **UWAGA !!!**

MONTOWANIE USZKODZONYCH  
ELEMENTÓW POWODUJE UTRATĘ  
GWARANCJI

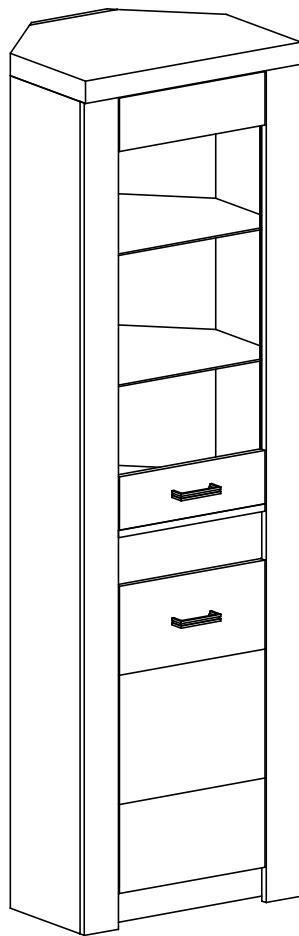

Nr	D[mm]	S[mm]	G[mm]	Ilość
1	527	453	16	1
2	1870	280	16	1
3	1870	280	16	1
4	527	435	16	1
5	527	80	16	1
6	527	123	16	1
7	1870	80	16	1
8	1870	80	16	1
9	1870	220	16	1
10	563	470	48	1
11	1800	255	2,5	2
12	527	425	16	1
13	781	395	4	1
14	395	120	16	1
15	395	120	16	1
16	526	423	4	2
17	665	395	16	1

## **UWAGA !!!**

Mebel zawiera  
elementy drewniane

W przypadku reklamacji proszę podać numer pakowacza znajdujący się na kartonie.

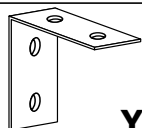

**Y - 1 St.**

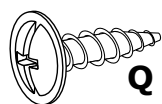

**Q - 2 St.**  
3,5x16 mm



**X1 - 12 St.**



**X2 - 14 St.**

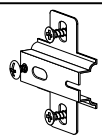

**C - 4 St.**

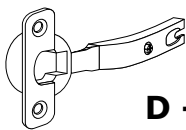

**D - 4 St.**

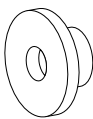

**R - 6 St.**

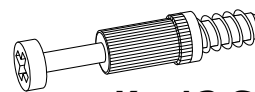

**K - 12 St.**

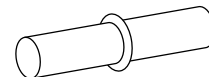

**P - 6 St.**

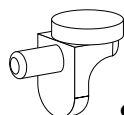

**S - 14 St.**

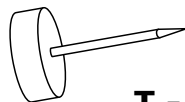

**T - 8 St.**



**U - 2 St.**

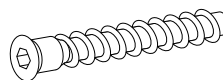

**A - 14 St.**

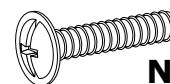

**N - 4 St.**  
4x25 mm



**E - 50 St.**

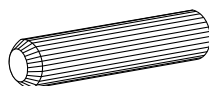

**B - 24 St.**

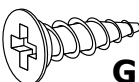

**G - 14 St.**  
3,5x16 mm



**Z - 1 St.**

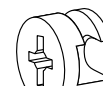

**L - 12 St.**

I

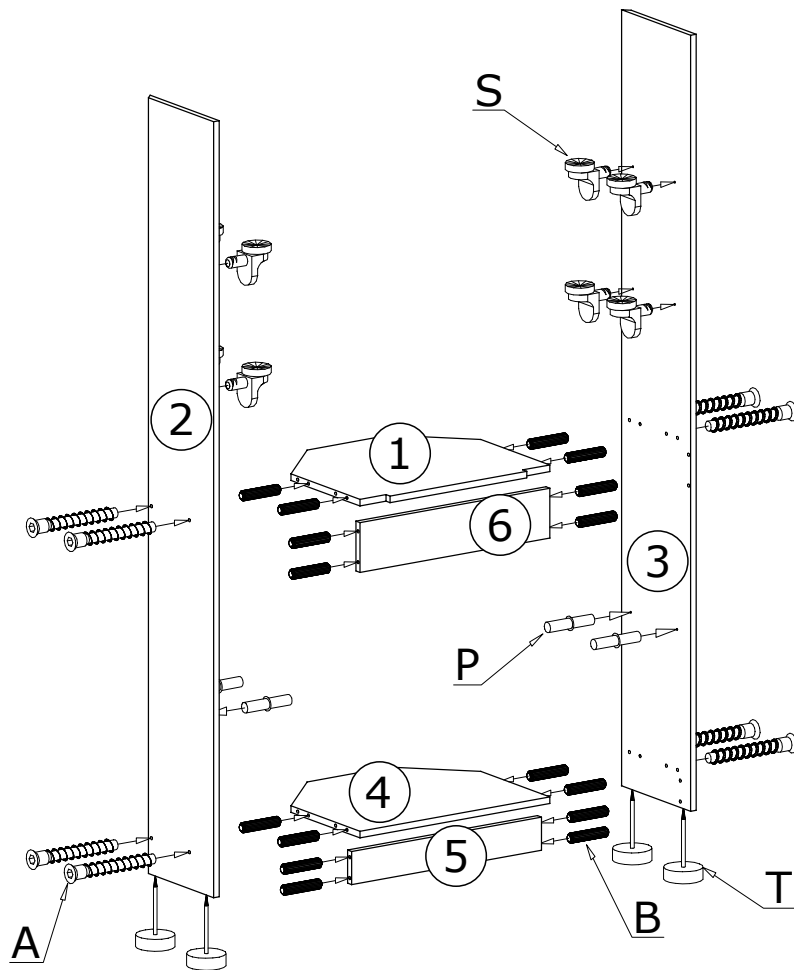

II

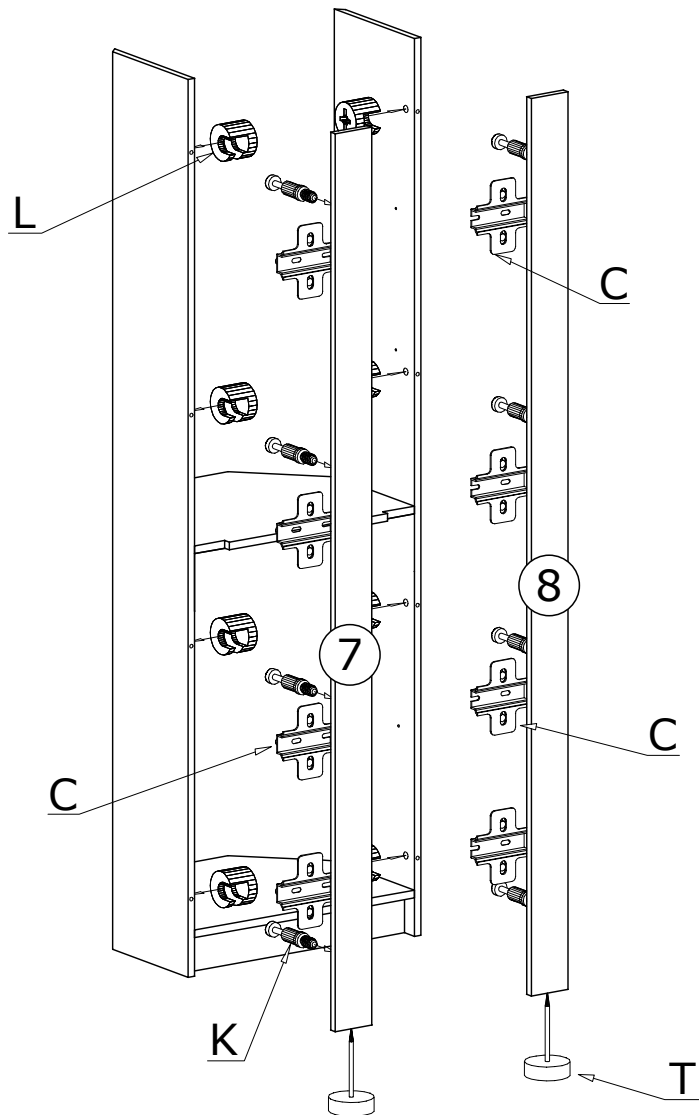

Prowadnik zawiasu "C" zamontować na lewej lub prawej listwie w zależności, na którą stronę mają otwierać się drzwi.

III

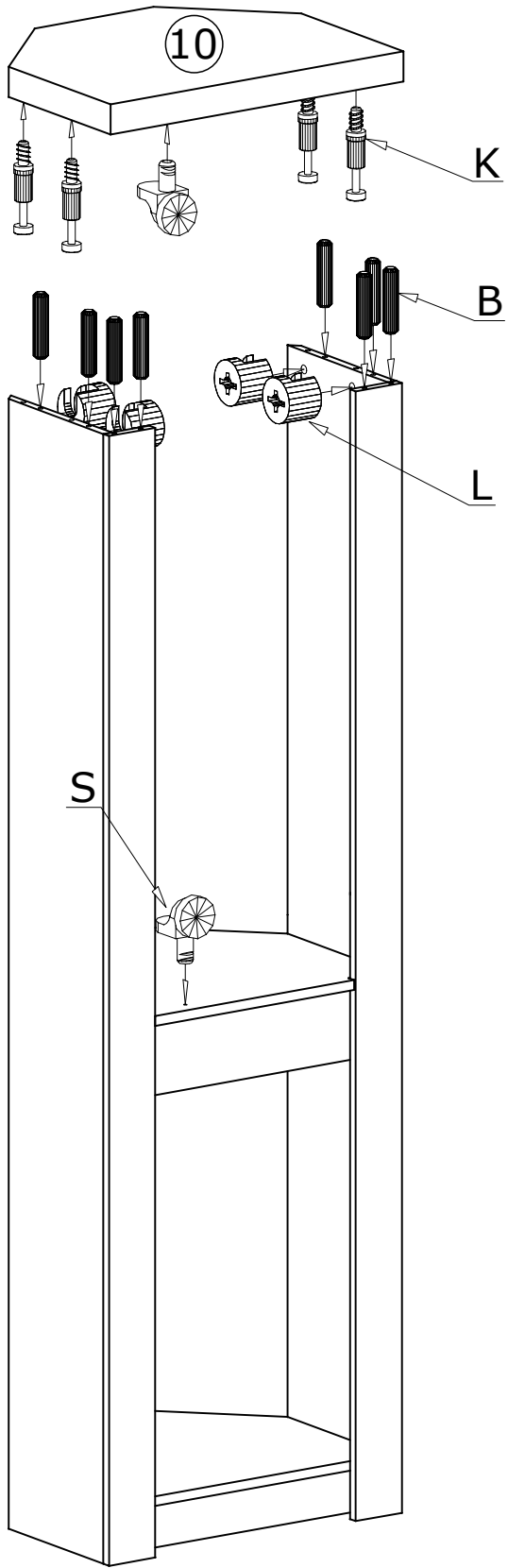

IV

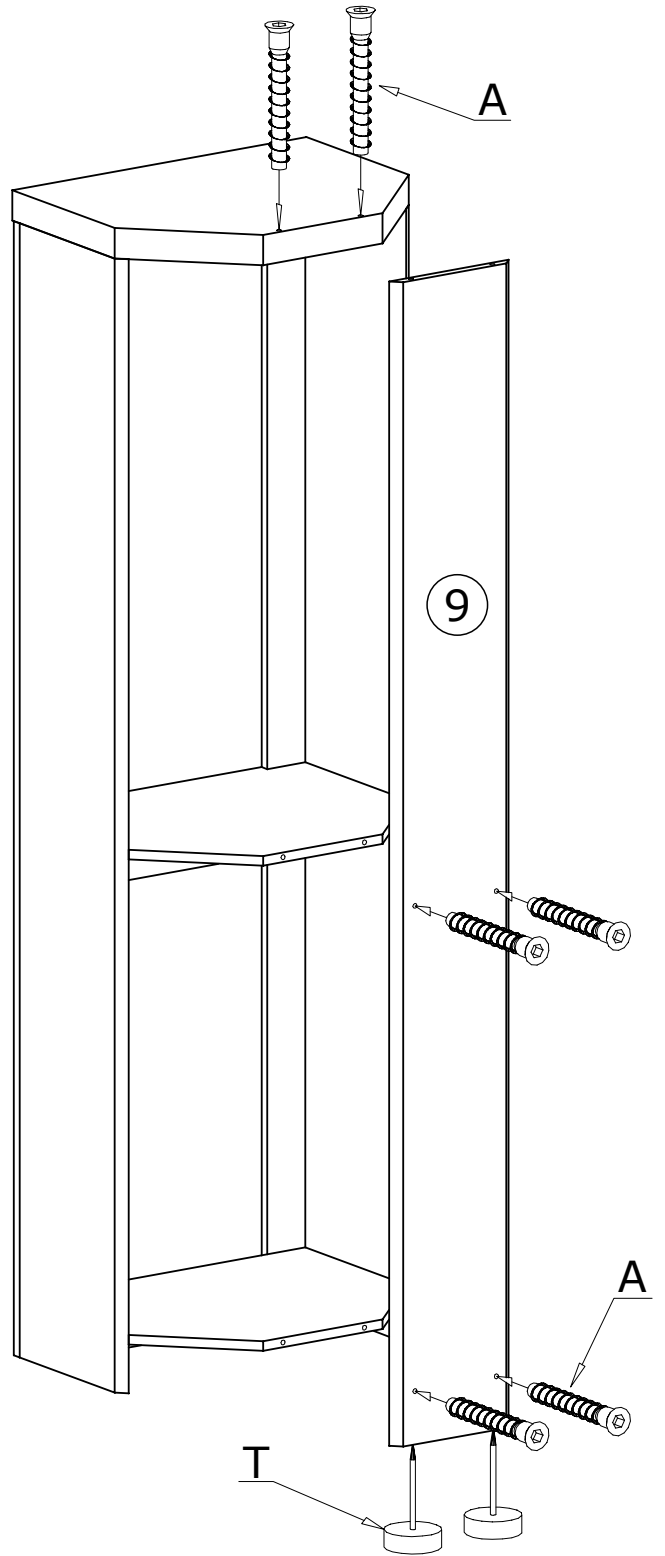

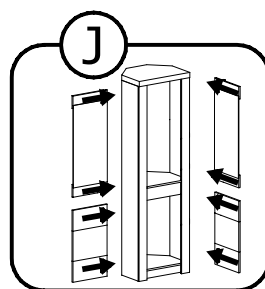
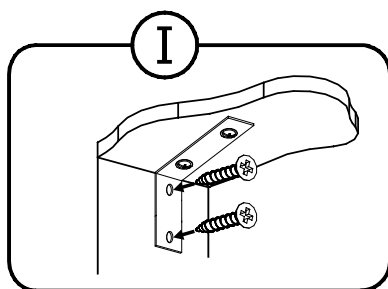
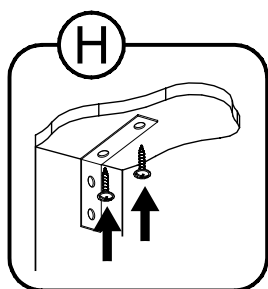
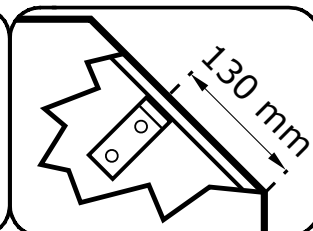
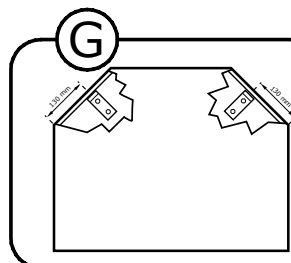
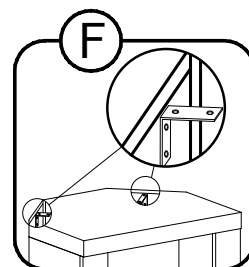
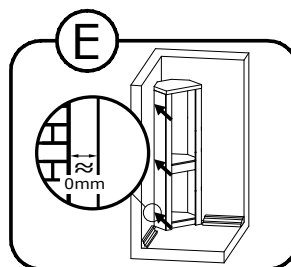
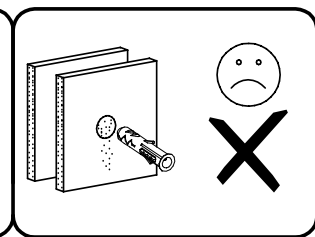
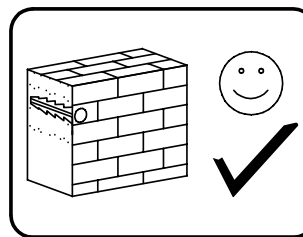
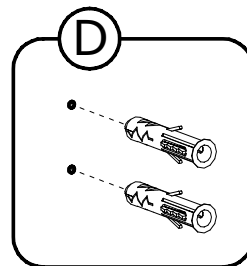
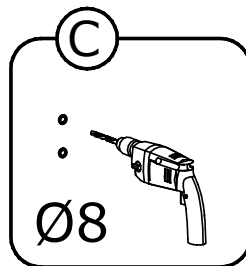
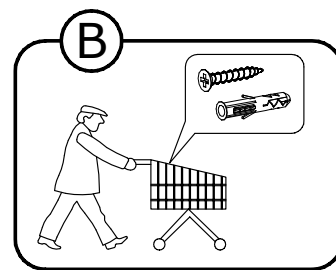
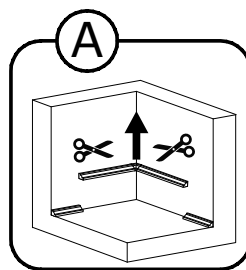
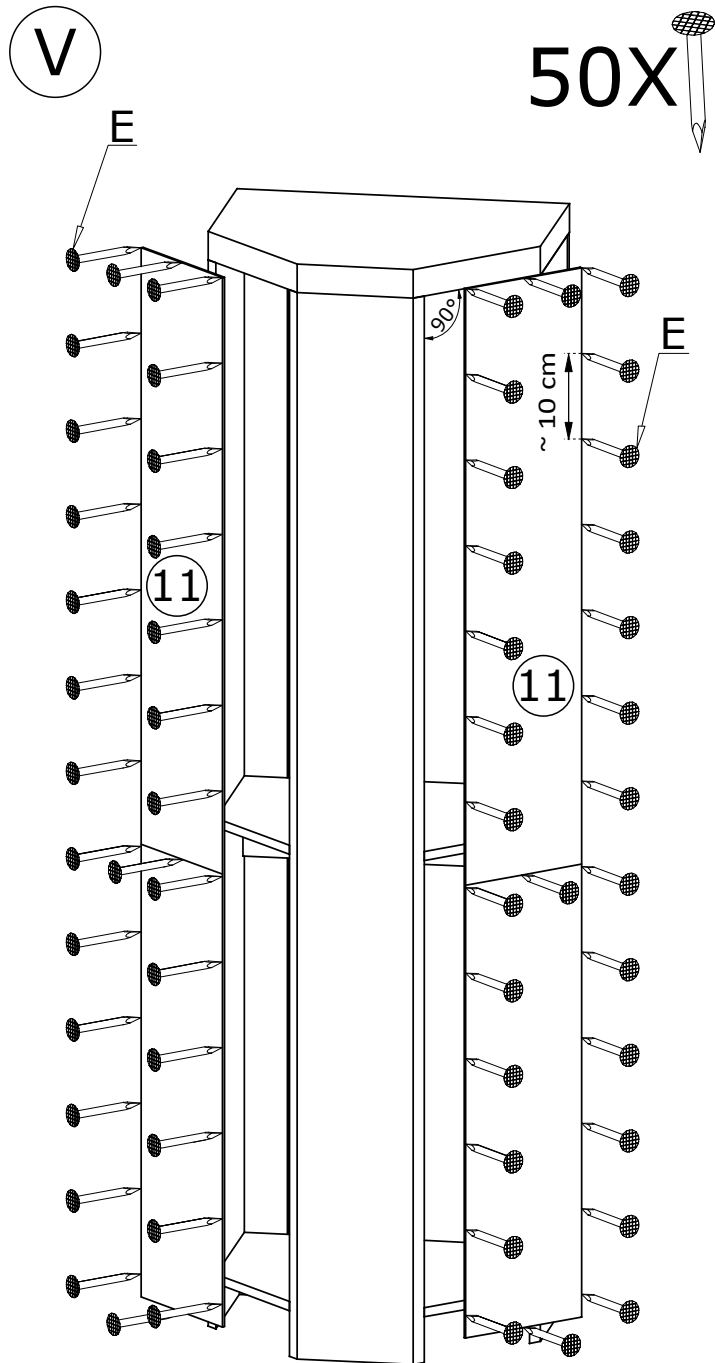

Meble zawierają elementy drewniane, których barwa i układ słoju są uzależnione od wielu czynników, dlatego mogą występować różnice w fakturze i barwie co nie stanowi wady produktu i nie wpływa na jego jakość, trwałość i funkcjonalność.

Listwy drewniane mogą ujawniać niewielkie zmiany w kształcie i wymiarach wywołane specyficznymi warunkami eksploatacji takimi jak: wilgotność, różnice temperatur, etc.

VI

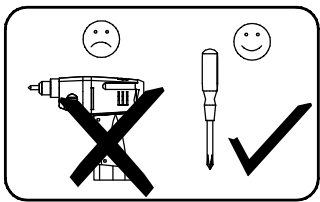
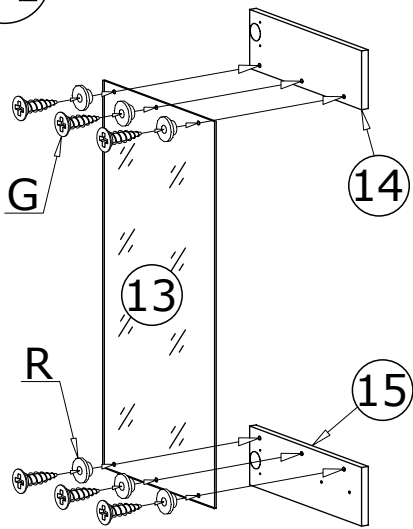

Drzwi zamontować na lewą lub prawą stronę.

VII

