

# INDIANAPOLIS 21

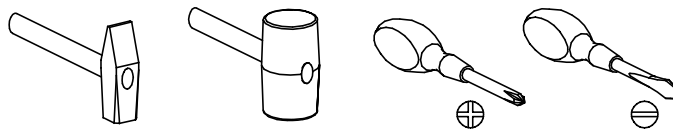

Narzędzia potrzebne do montażu



## UWAGA !!!

MONTOWANIE USZKODZONYCH  
ELEMENTÓW POWODUJE UTRATĘ  
GWARANCJI

Nr	D[mm]	S[mm]	G[mm]	Ilość
1	1338	300	16	2
2	368	295	16	1
3	368	295	16	1
4	400	300	16	1
5	400	300	16	1
6	395	80	16	2
7	360	405	4	2
8	434	270	4	2
9	1360	390	2,5	1

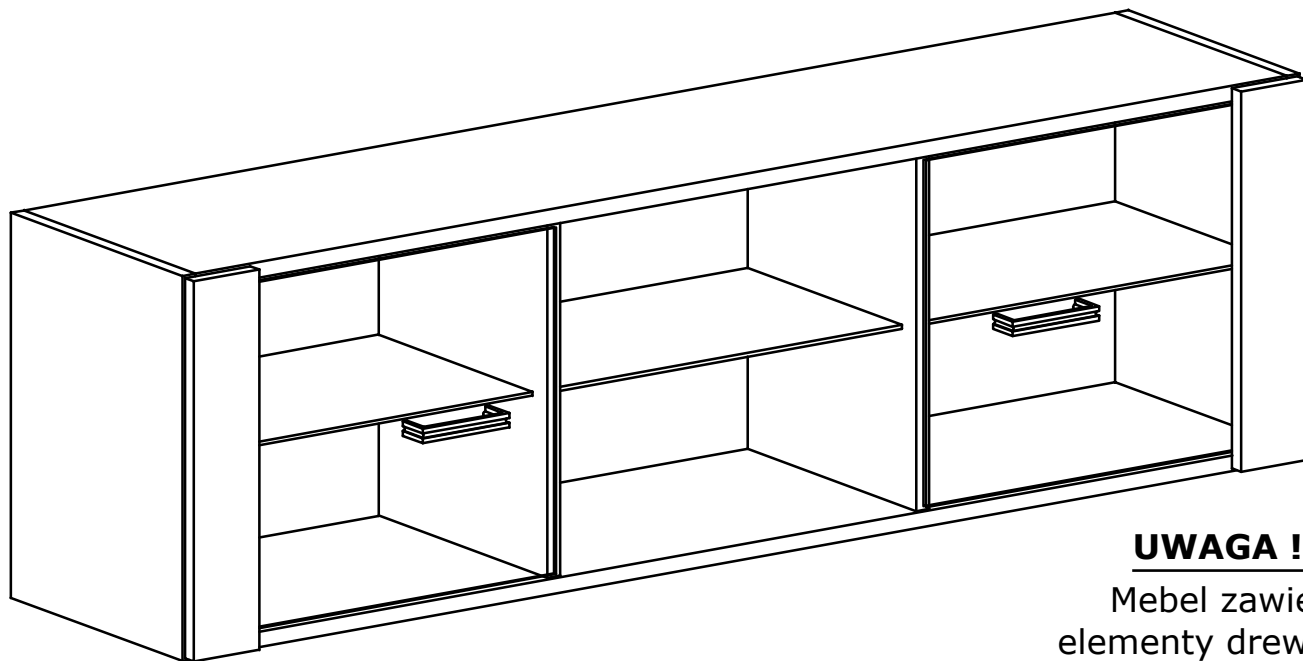

## UWAGA !!!

Mebel zawiera  
elementy drewniane

W przypadku reklamacji proszę podać numer pakowacza znajdujący się na kartonie.

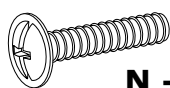

**N - 4 St.**  
4x14 mm

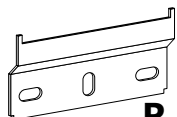

**P - 2 St.**



**X1 - 8 St.**



**X2 - 8 St.**

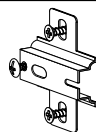

**C - 4 St.**

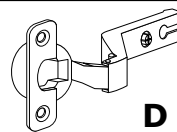

**D - 4 St.**

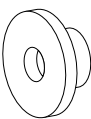

**R - 10 St.**

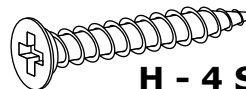

**H - 4 St.**  
3x30 mm

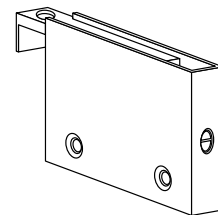

**J - 2 St.**

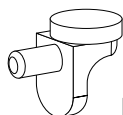

**F - 12 St.**

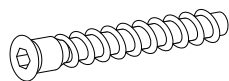

**A - 8 St.**



**U - 2 St.**

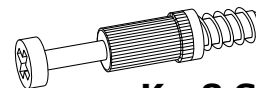

**K - 8 St.**

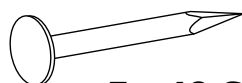

**E - 40 St.**

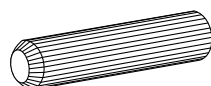

**B - 16 St.**

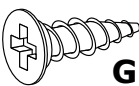

**G - 14 St.**  
3,5x16 mm



**Z - 1 St.**



**L - 8 St.**

I

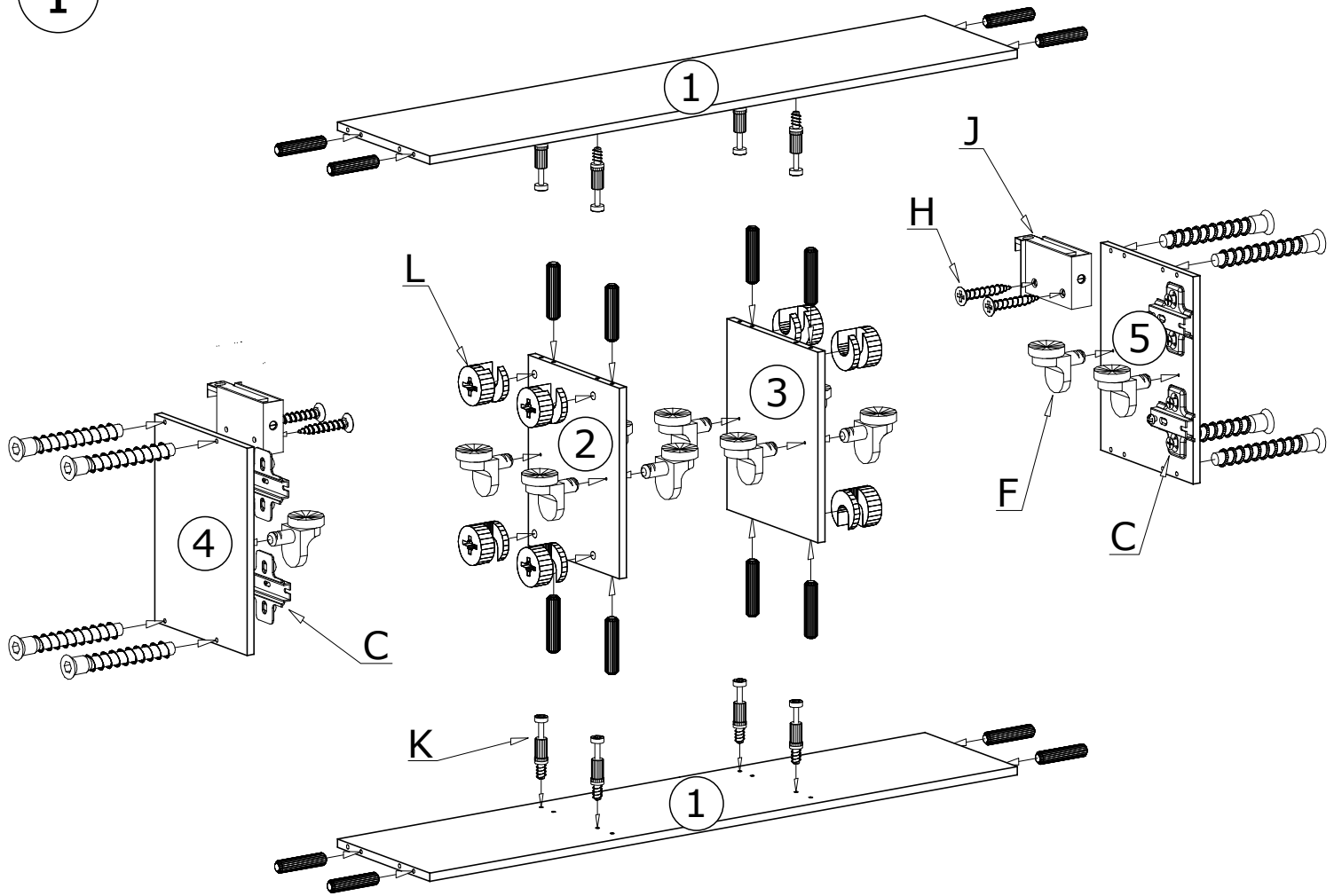

II

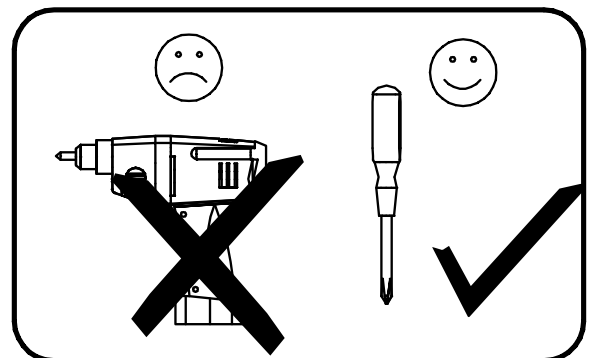
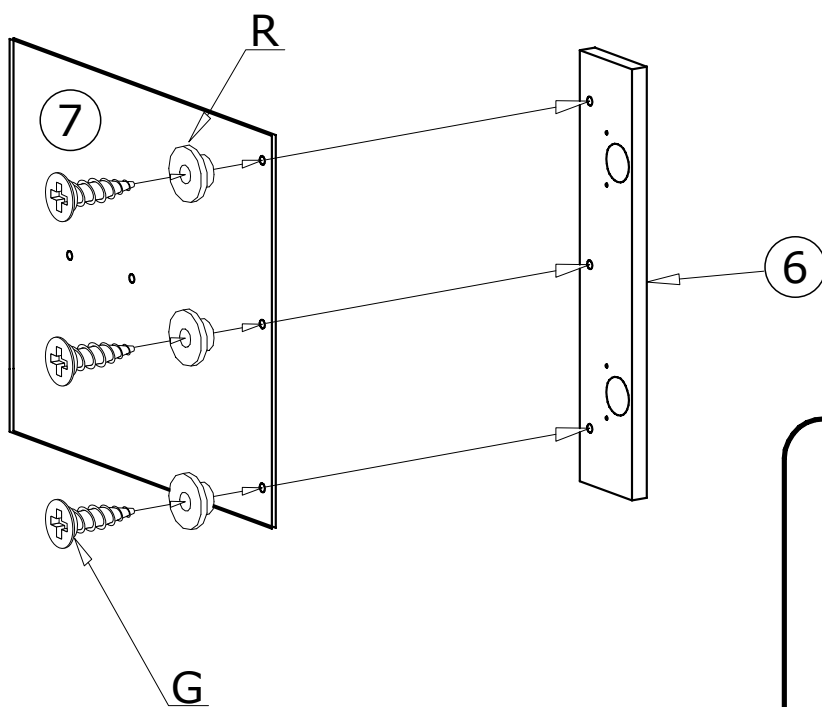

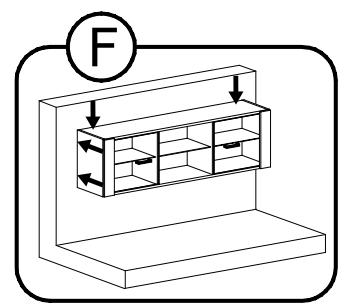
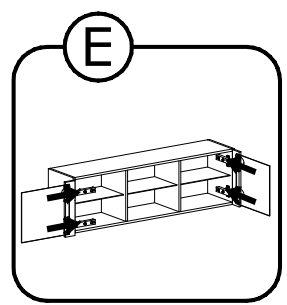
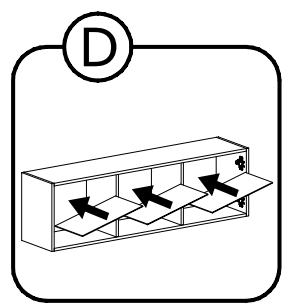
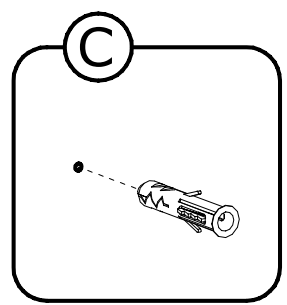
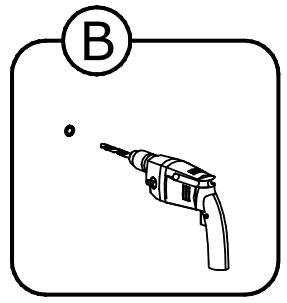
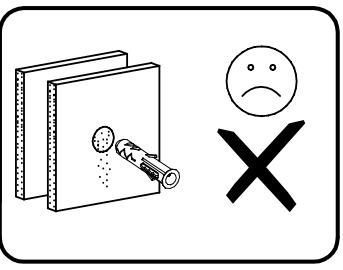
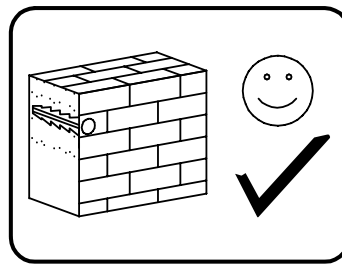
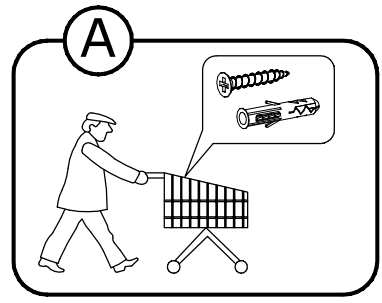
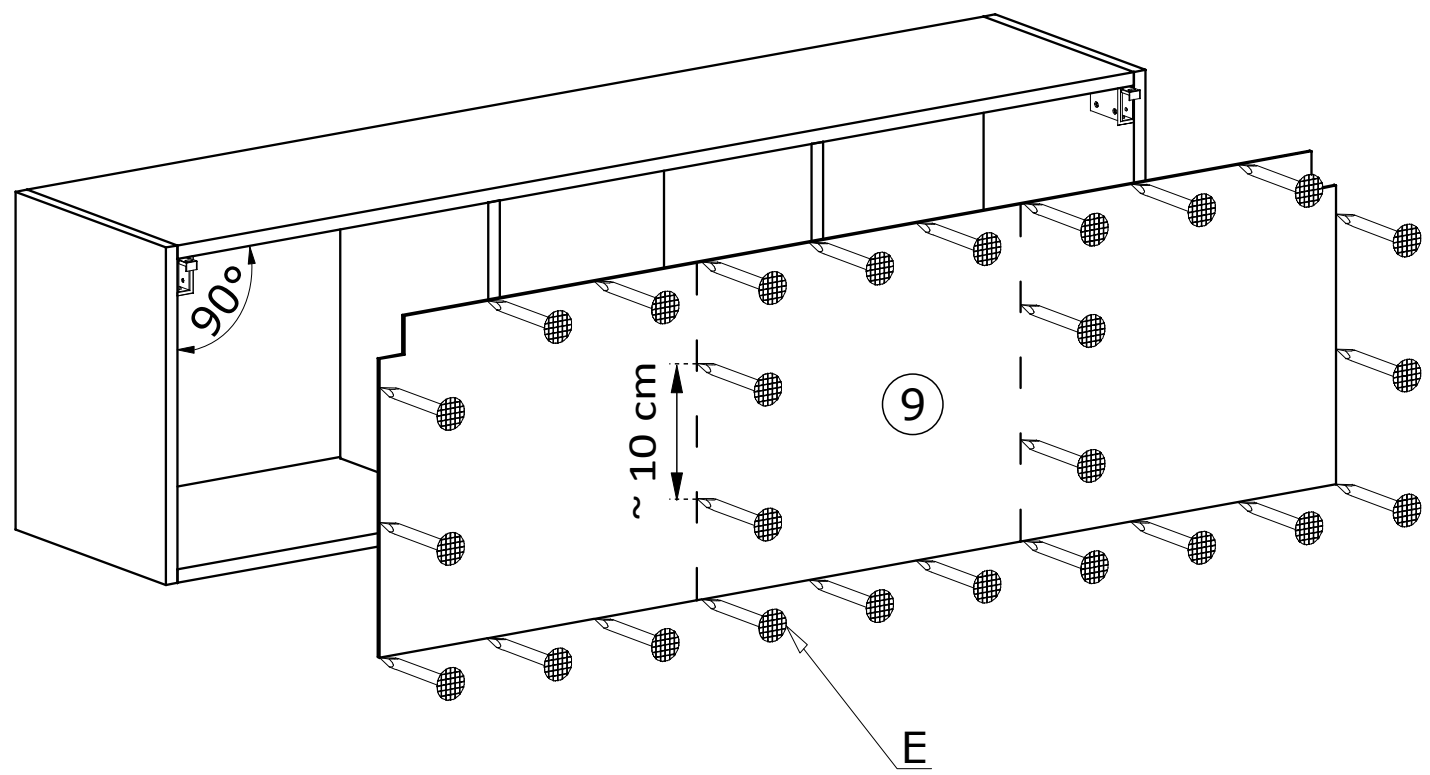

Meble zawierają elementy drewniane, których barwa i układ słojów są uzależnione od wielu czynników, dlatego mogą występować różnice w fakturze i barwie co nie stanowi wady produktu i nie wpływa na jego jakość, trwałość i funkcjonalność.

Listwy drewniane mogą ujawniać niewielkie zmiany w kształcie i wymiarach wywołane specyficznymi warunkami eksploatacji takimi jak: wilgotność, różnice temperatur, etc.

IV

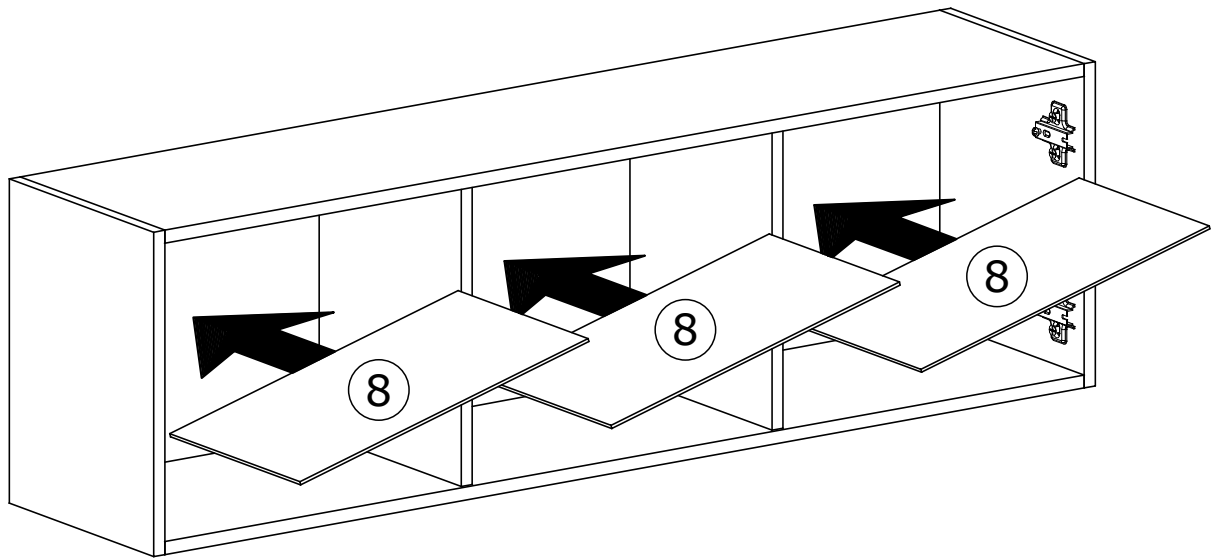

V

