

INDIANAPOLIS 18



Narzędzia potrzebne do montażu



UWAGA !!!

MONTOWANIE USZKODZONYCH
ELEMENTÓW POWODUJE UTRATĘ
GWARANCJI

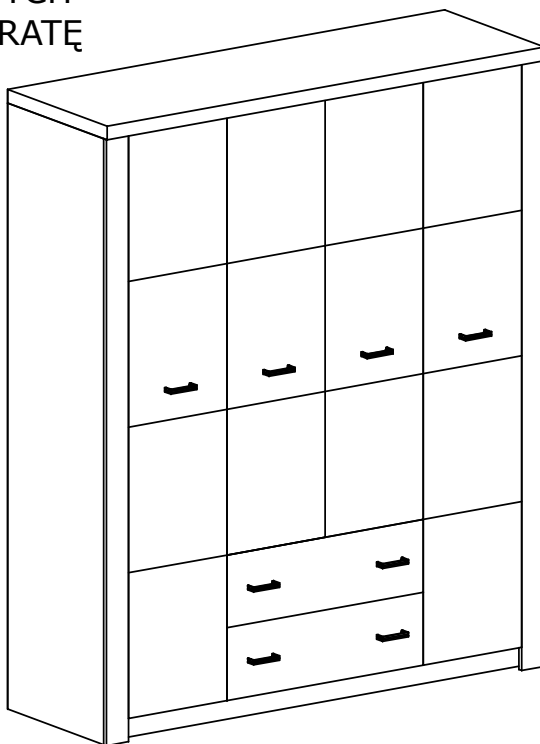

Nr	D[mm]	S[mm]	G[mm]	Ilość
1	1988	563	16	1
2	1988	563	16	1
3	784	563	16	1
4	1744	563	16	1
5	2085	563	16	1
6	2085	563	16	1
7	2085	80	16	1
8	2085	80	16	1
9	1744	80	16	2
10	1778	580	48	1
11	757	505	2,5	2
12	803	190	16	2
13	500	150	16	2
14	500	150	16	2
15	728	150	16	2
16	2015	483	2,5	2
17	2015	800	2,5	1
18	463	563	16	4
19	784	563	16	1
20	1988	400	16	1
21	1988	400	16	1
22	1600	400	16	1
23	1600	400	16	1

W przypadku reklamacji proszę podać numer pakowacza znajdujący się na kartonie.

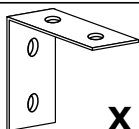

X - 1 St.

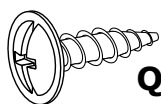

Q - 2 St.
3,5x16 mm



X1 - 30 St.



X2 - 10 St.

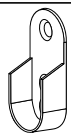

Z - 6 St.

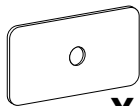

Y - 20 St.

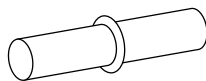

W - 20 St.

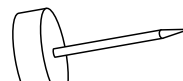

I - 10 St.

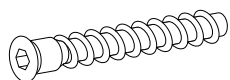

A - 10 St.

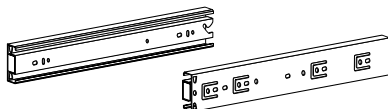

T - 2 Kpl.

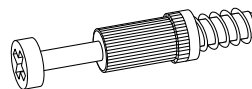

K - 30 St.

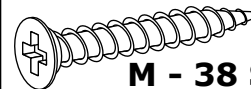

M - 38 St.
3x30 mm

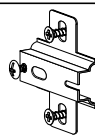

C - 14 St.

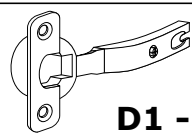

D1 - 8 St.



R - 2 St.
455 mm



F - 1 St.
776 mm



J - 16 St.
5x13 mm

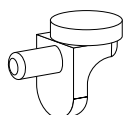

S - 2 St.

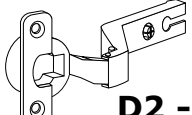

D2 - 6 St.

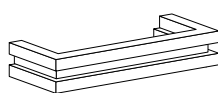

U - 8 St.

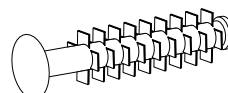

P - 8 St.

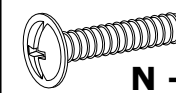

N - 16 St.
4x22 mm



E - 90 St.

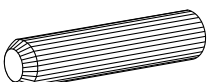

B - 42 St.

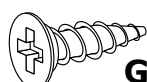

G - 60 St.
3,5x16 mm

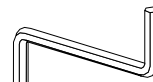

O - 1 St.



L - 30 St.

I

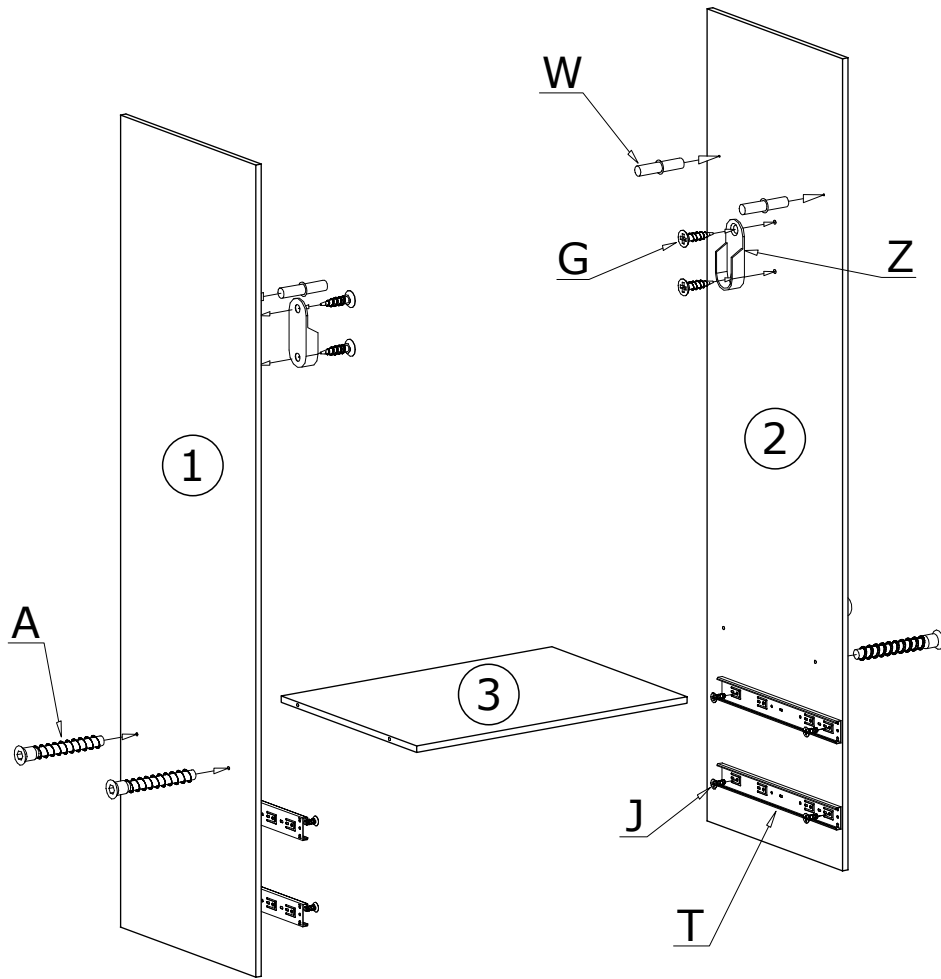

II

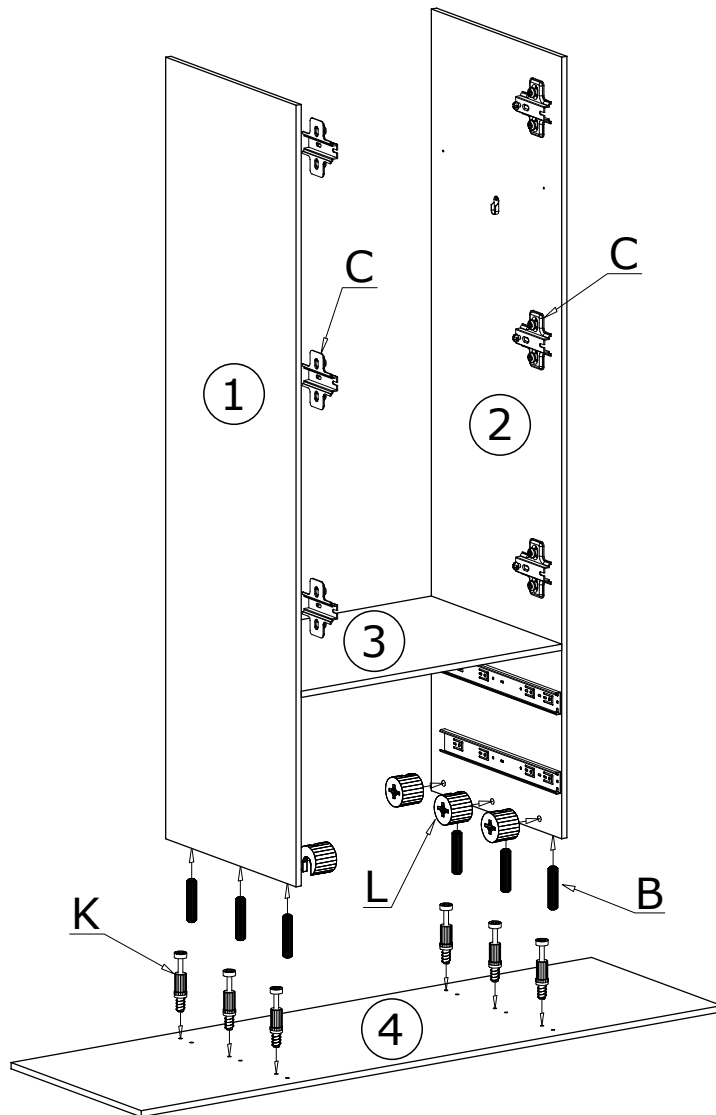

III

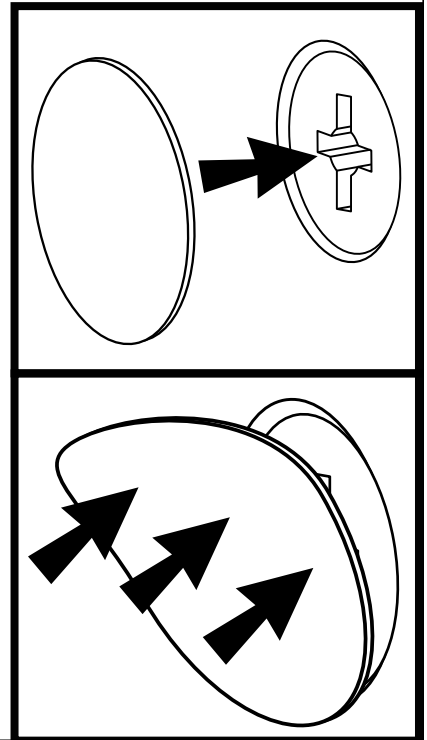
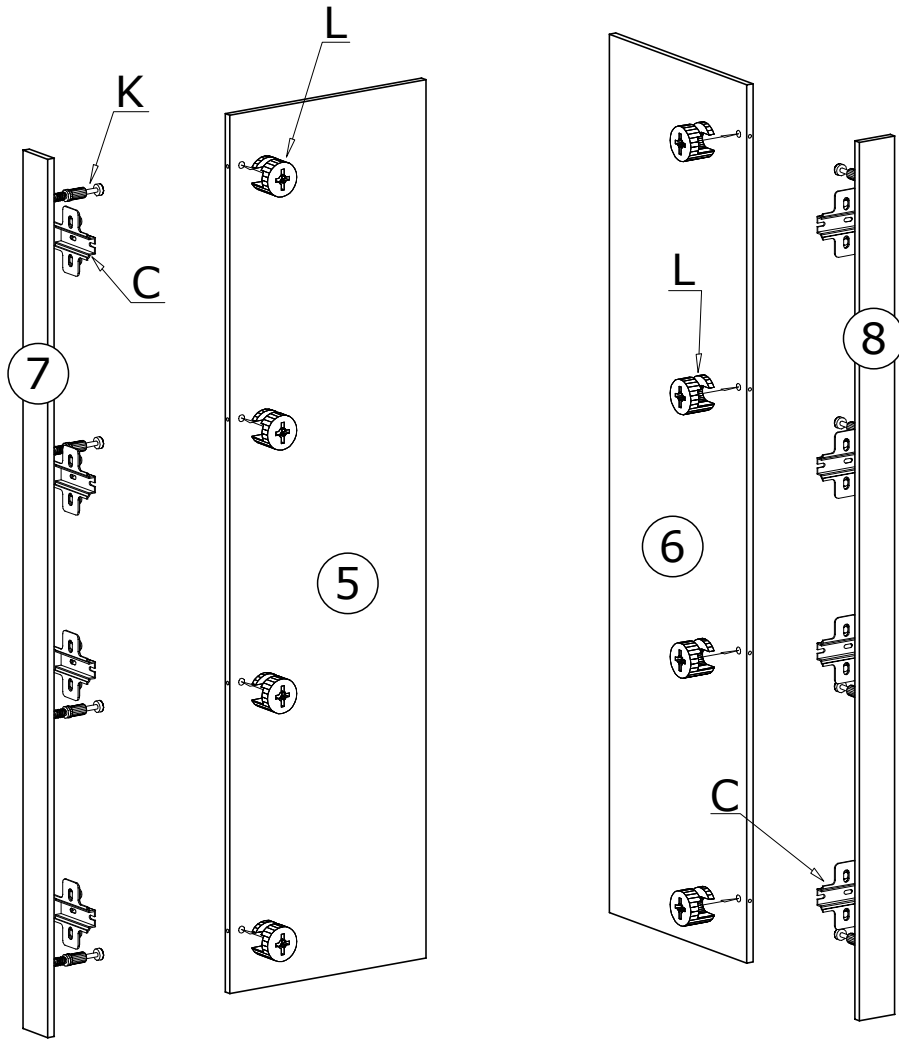

IV

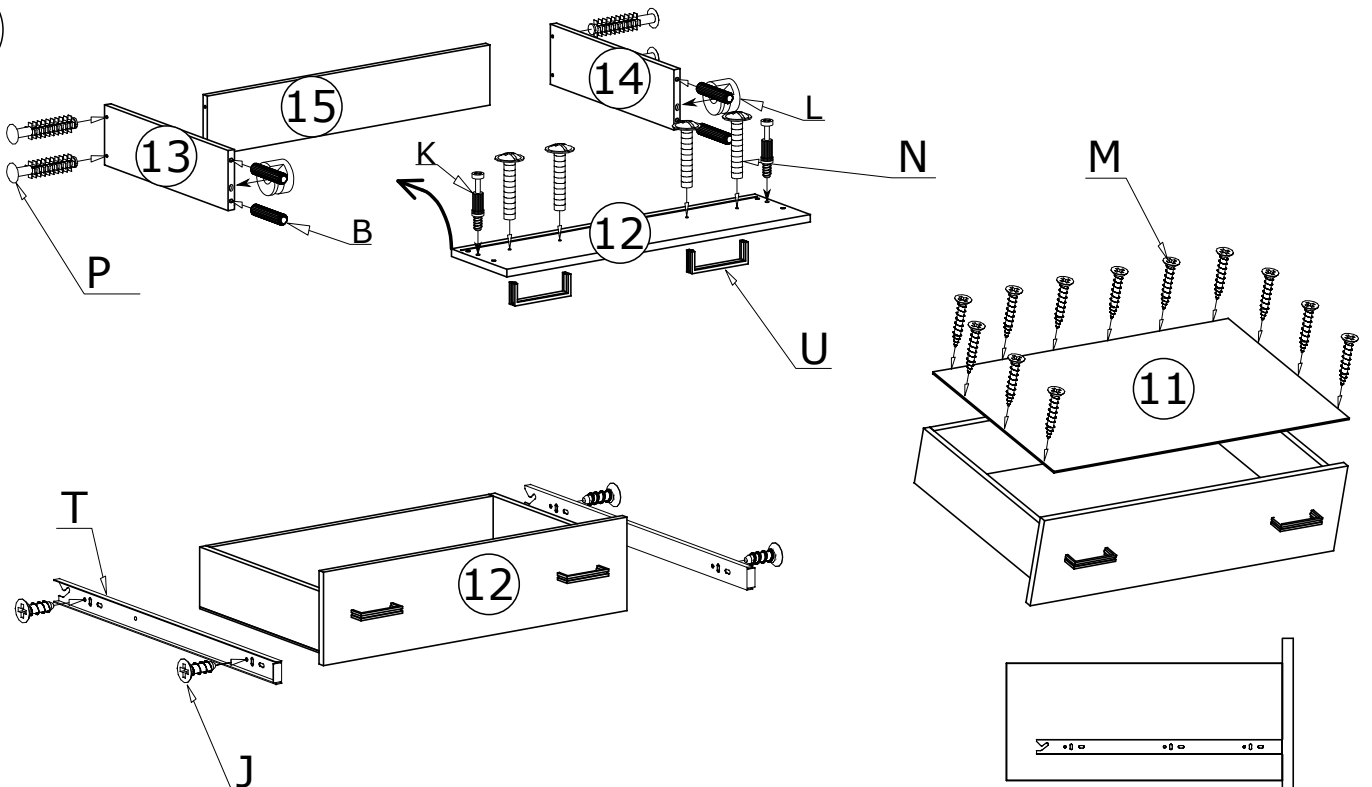

V

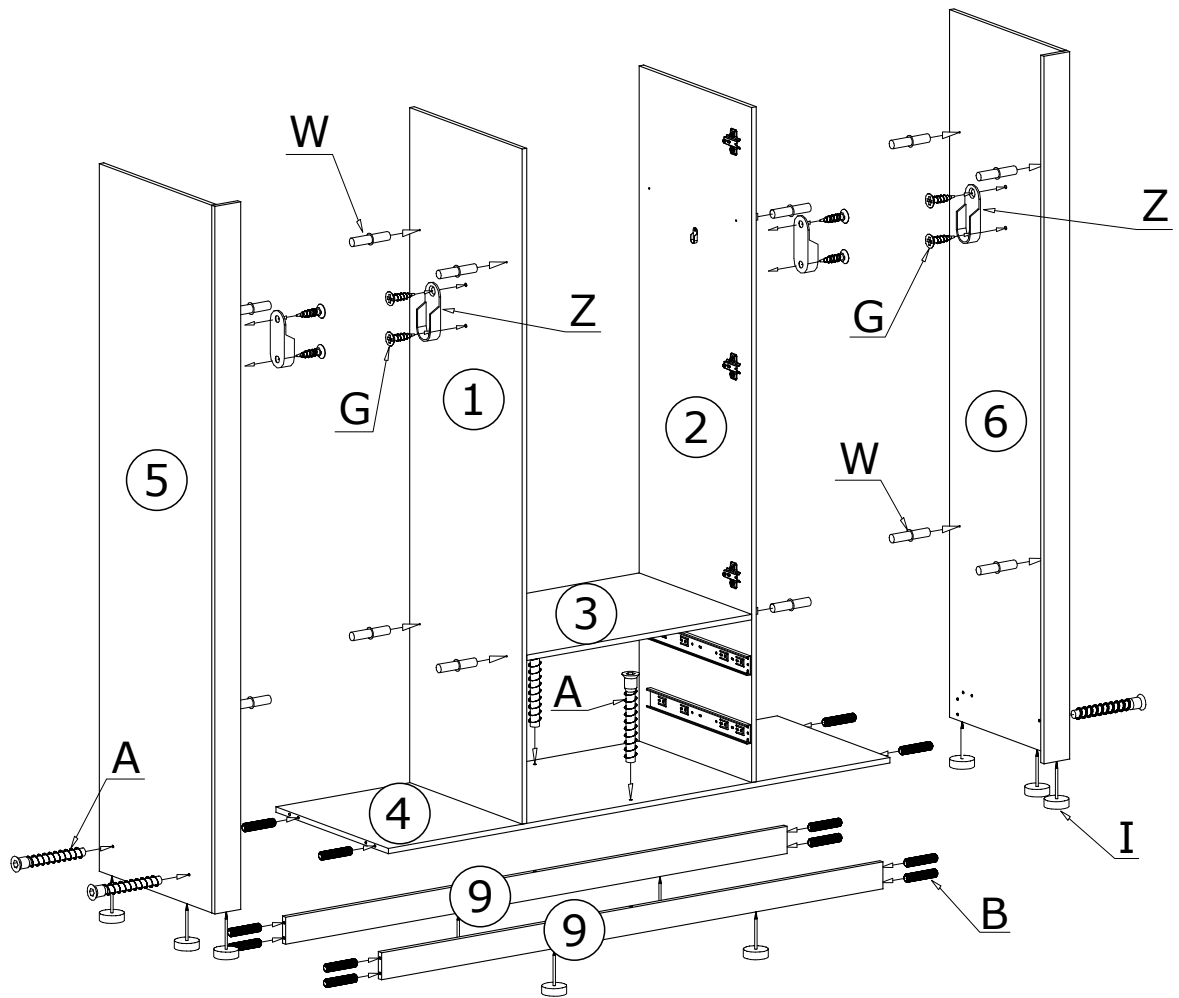

VI

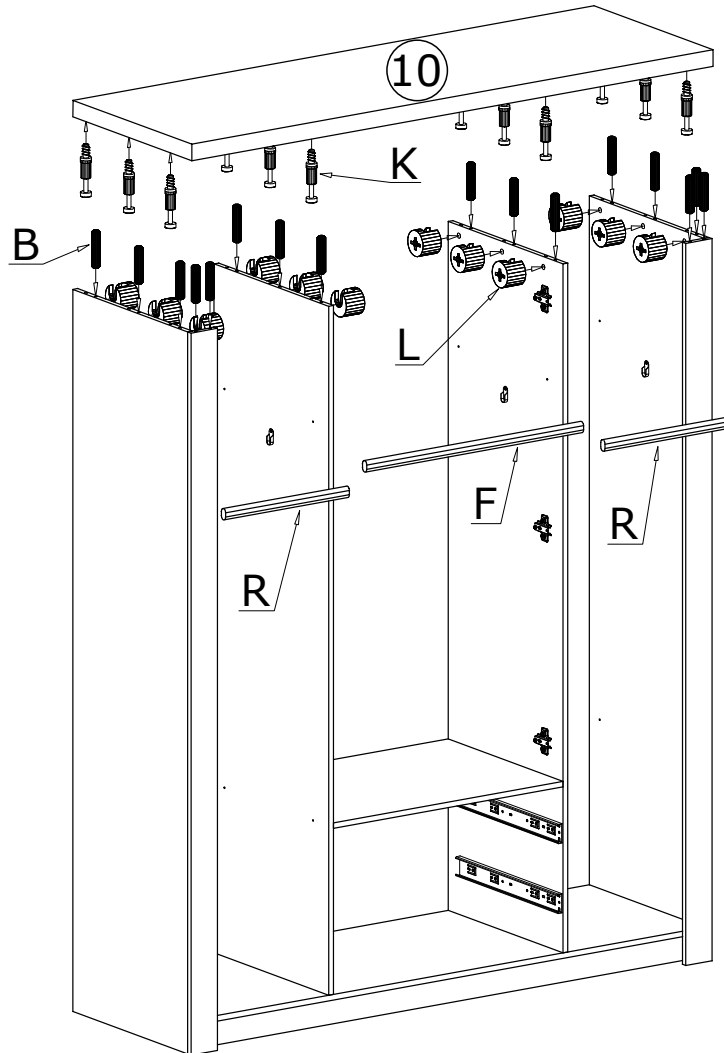

VII

90X 

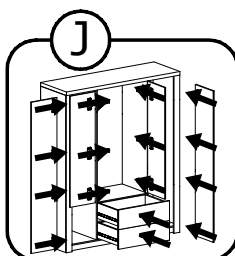
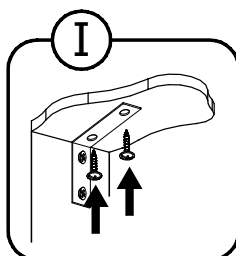
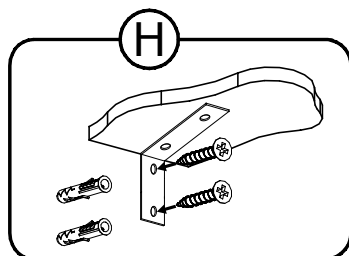
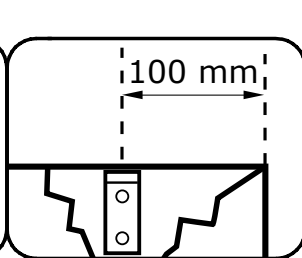
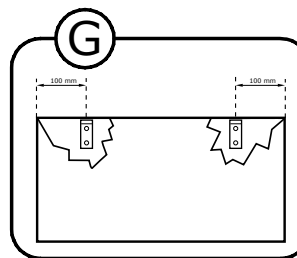
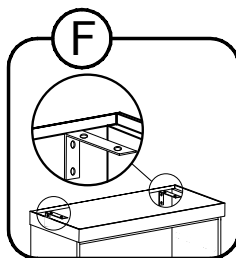
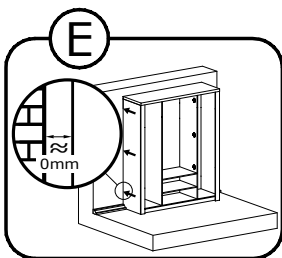
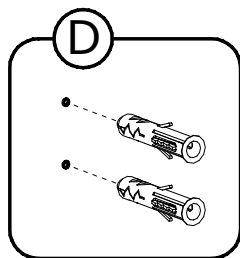
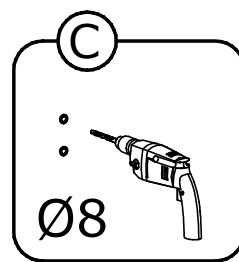
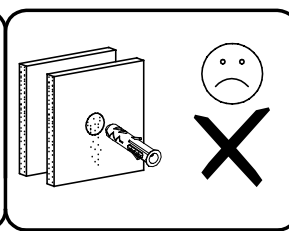
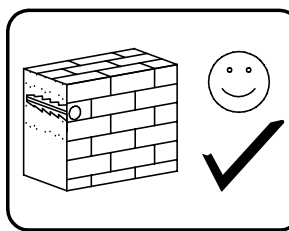
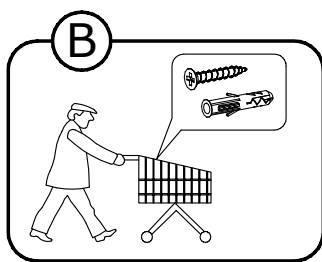
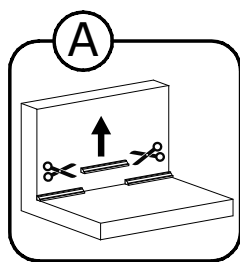
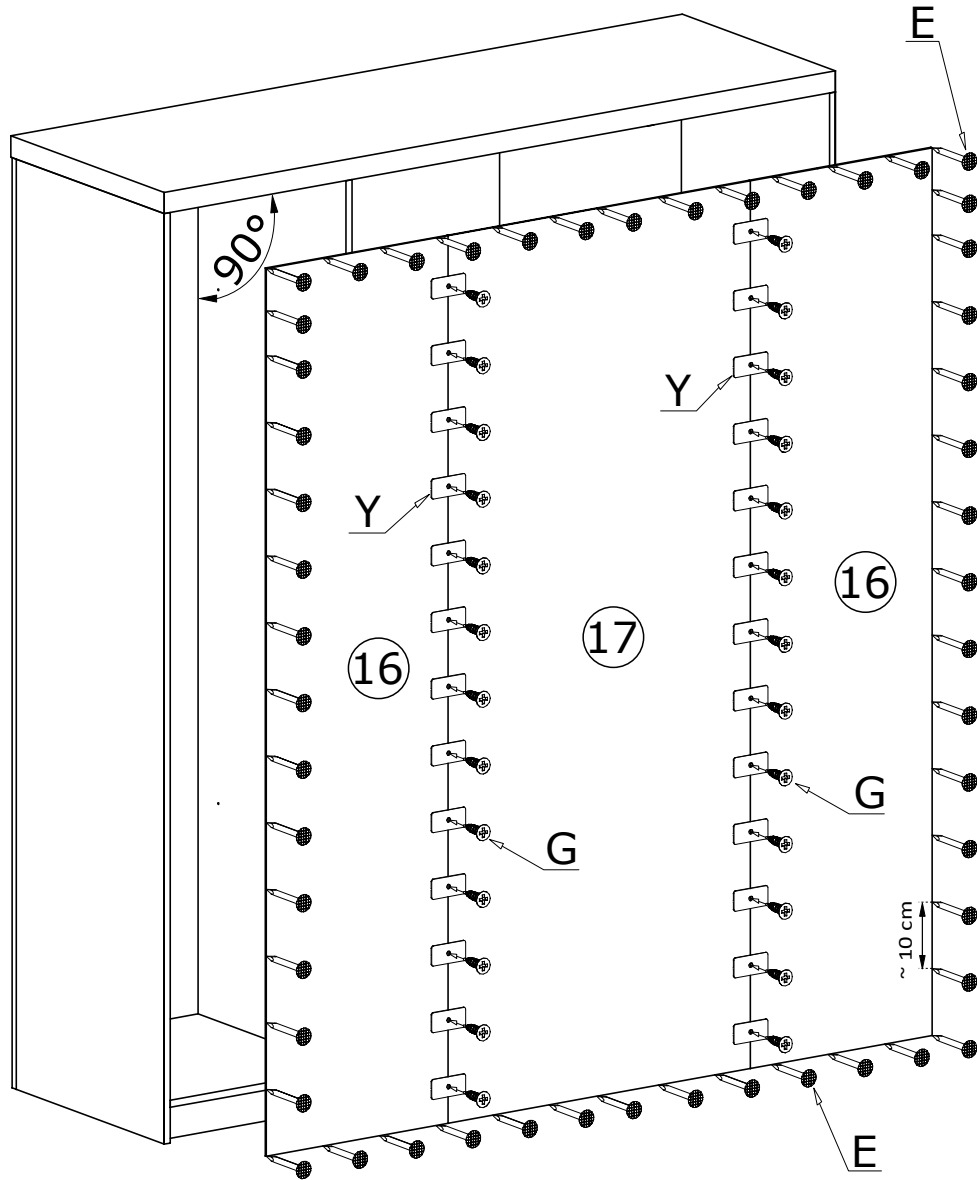

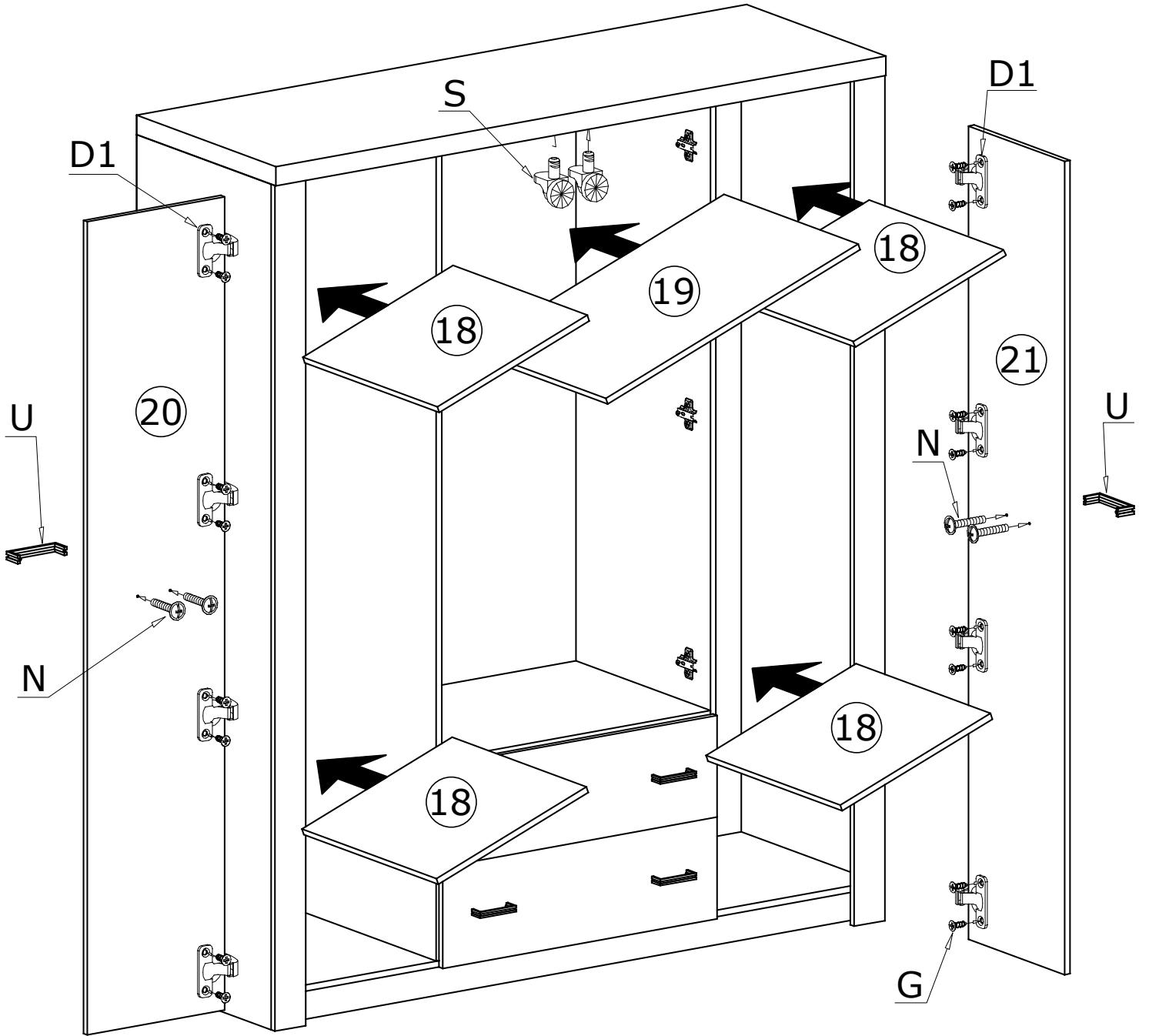

IX

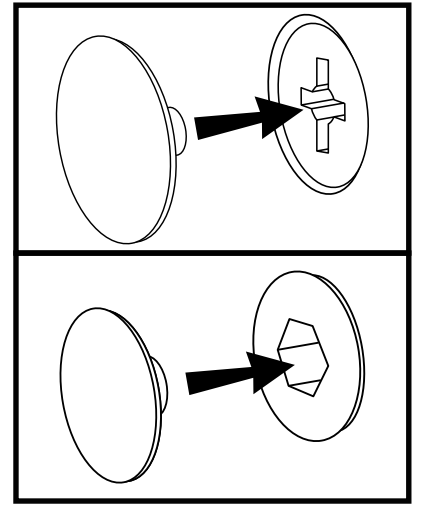
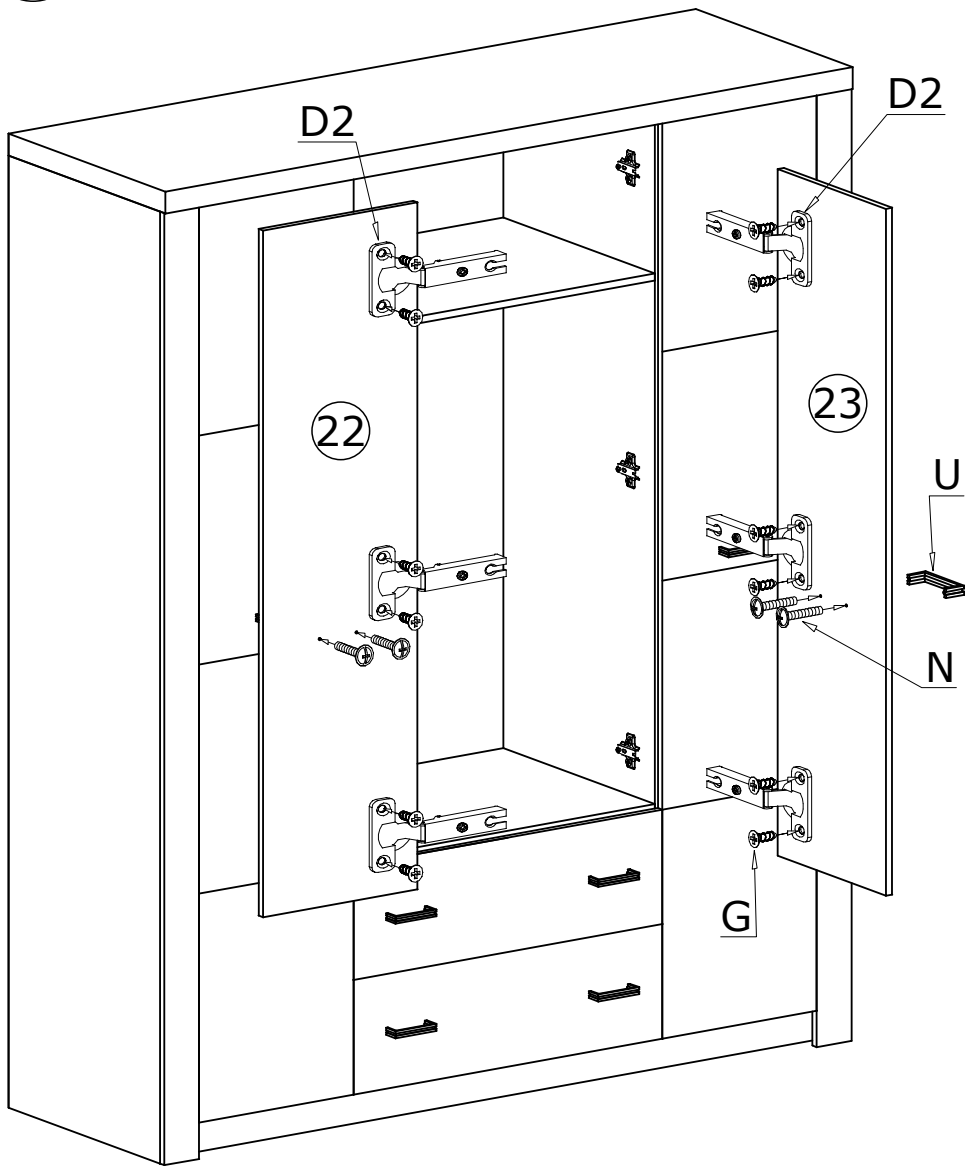

MONTAŻ/DEMONTAŻ PROWADNIC

1



2



3

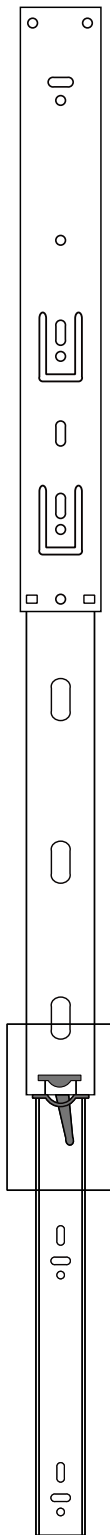

4

