

# DALLAS 23

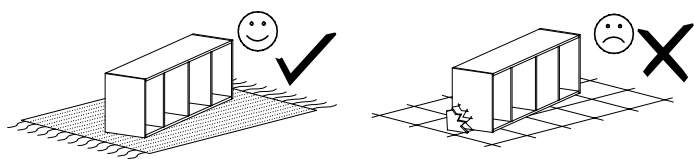

Narzędzia potrzebne do montażu

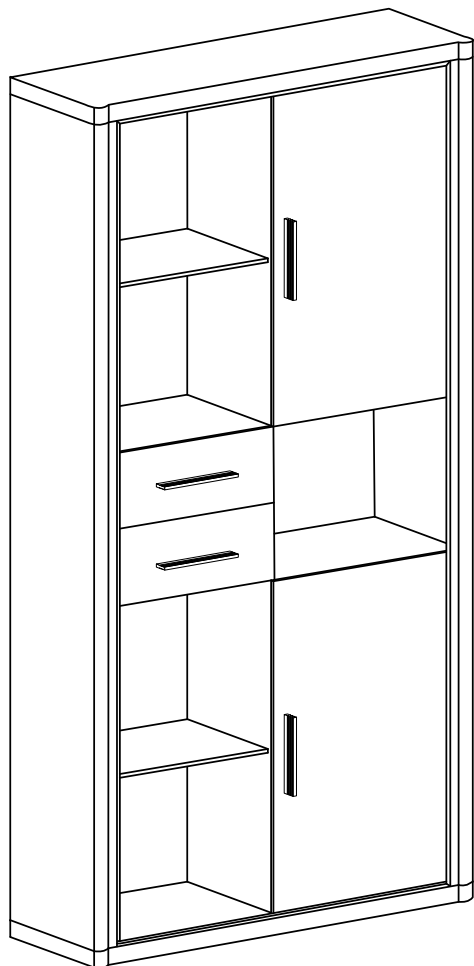
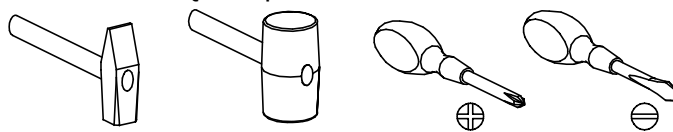

Nr	D[mm]	S[mm]	G[mm]	Ilość
1	970	422	16	1
2	970	422	16	1
3	1810	450	48	1
4	1810	450	48	1
5	1810	405	16	1
6	405	370	16	1
7	460	405	16	4
8	930	25	20	2
9	1810	100	32	2
10	1835	480	2,5	2
11	460	380	16	4
12	400	150	16	4
13	312	150	16	2
14	383	190	16	2
15	405	334	2,5	2
16	700	383	16	2

## UWAGA !!!

MONTOWANIE USZKODZONYCH  
ELEMENTÓW POWODUJE UTRATĘ  
GWARANCJI

W przypadku reklamacji proszę podać numer pakowacza znajdujący się na kartonie.

 <b>H - 15 St.</b>	 <b>Y - 1 St.</b>	 <b>I - 2 St.</b> 3,5x16 mm	 <b>X1 - 24 St.</b>	 <b>X2 - 8 St.</b>
 <b>R - 4 St.</b>	 <b>A - 4 St.</b>	 <b>M - 16 St.</b> 3,9x25 mm	 <b>T - 2 Kpl.</b>	
 <b>P - 16 St.</b>	 <b>N - 8 St.</b> 4x27 mm	 <b>C - 4 St.</b>	 <b>F - 8 St.</b>	
 <b>U - 4 St.</b>	 <b>G - 23 St.</b> 3,5x16 mm	 <b>D - 4 St.</b>	 <b>W - 8 St.</b>	 <b>L - 24 St.</b>
 <b>E - 80 St.</b>	 <b>B - 24 St.</b>	 <b>K - 24 St.</b>	 <b>Z - 1 St.</b>	 <b>J - 8 St.</b> 5x13 mm

I

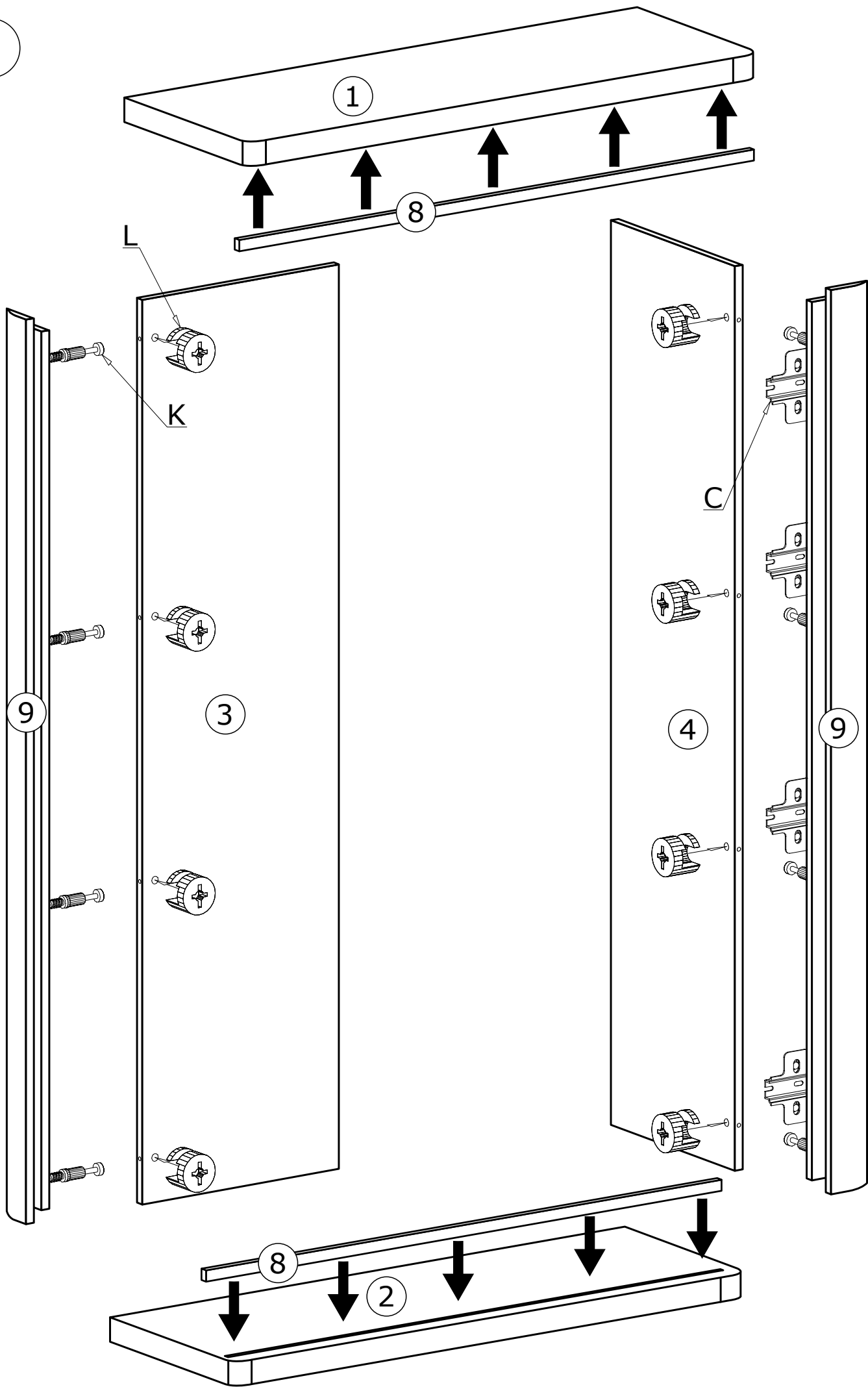

II

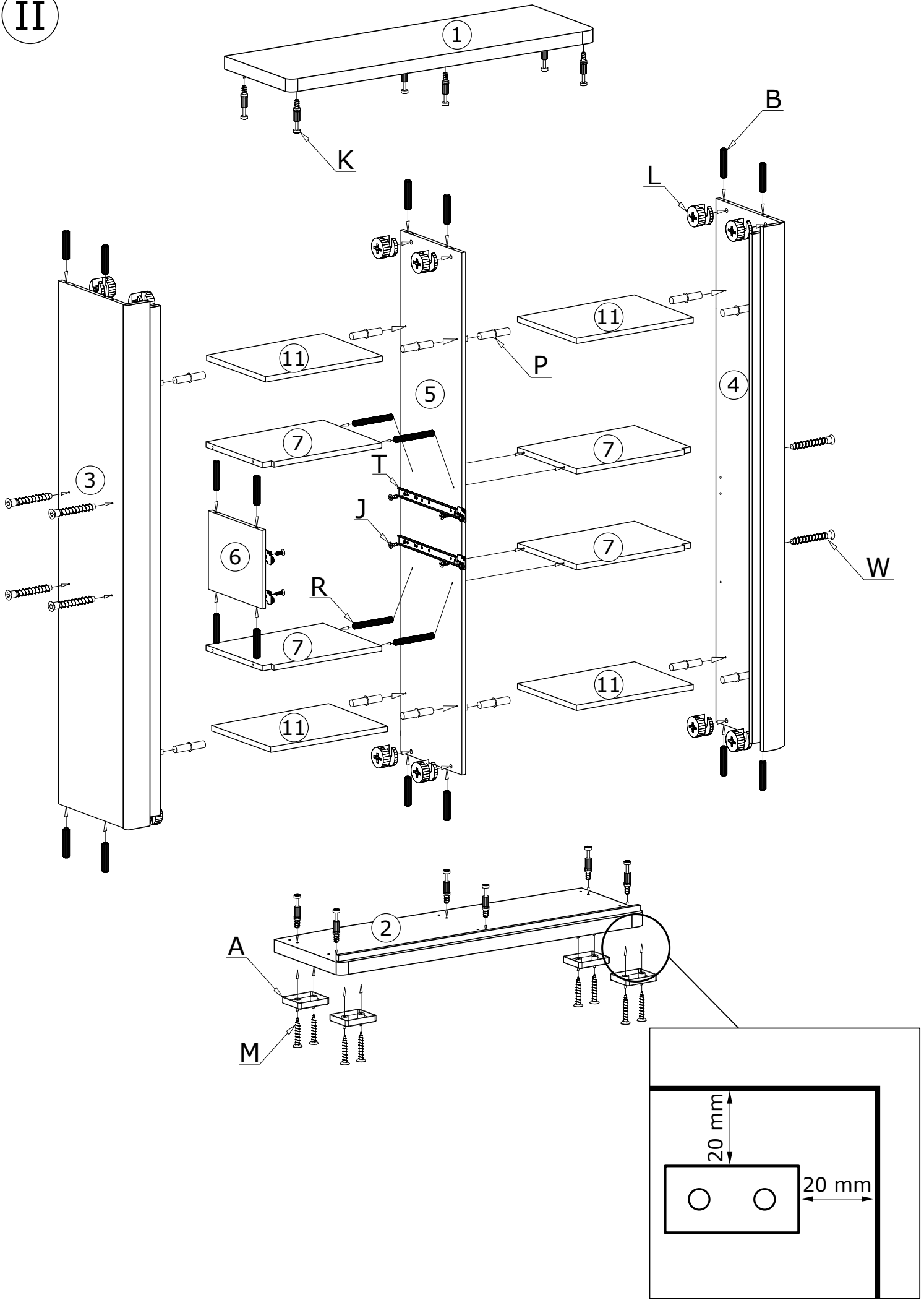

III

60X

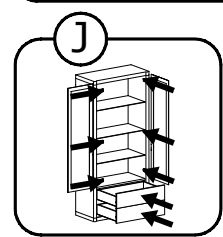
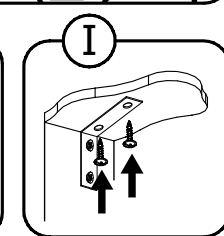
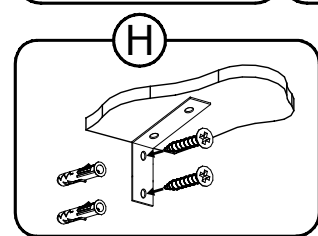
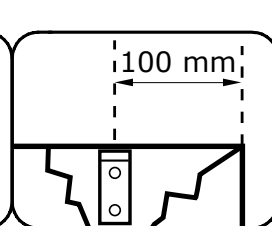
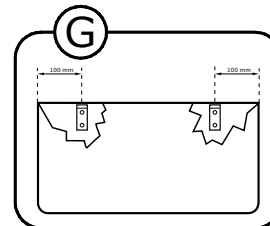
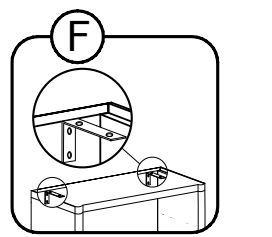
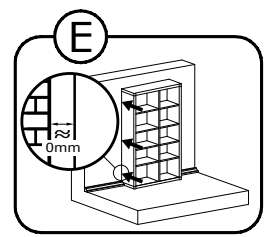
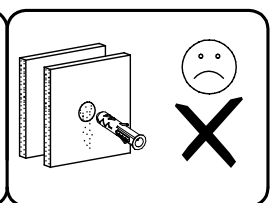
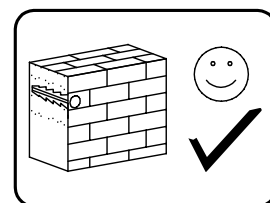
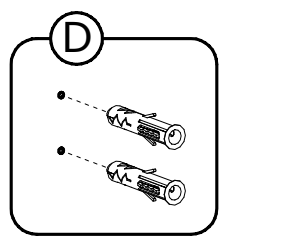
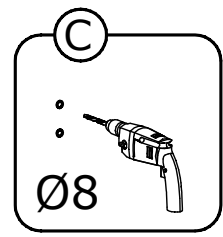
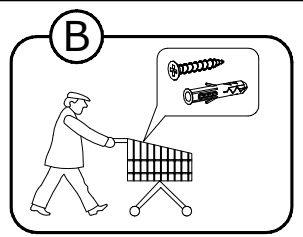
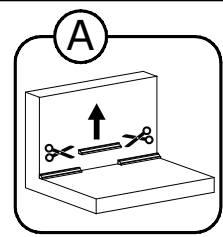
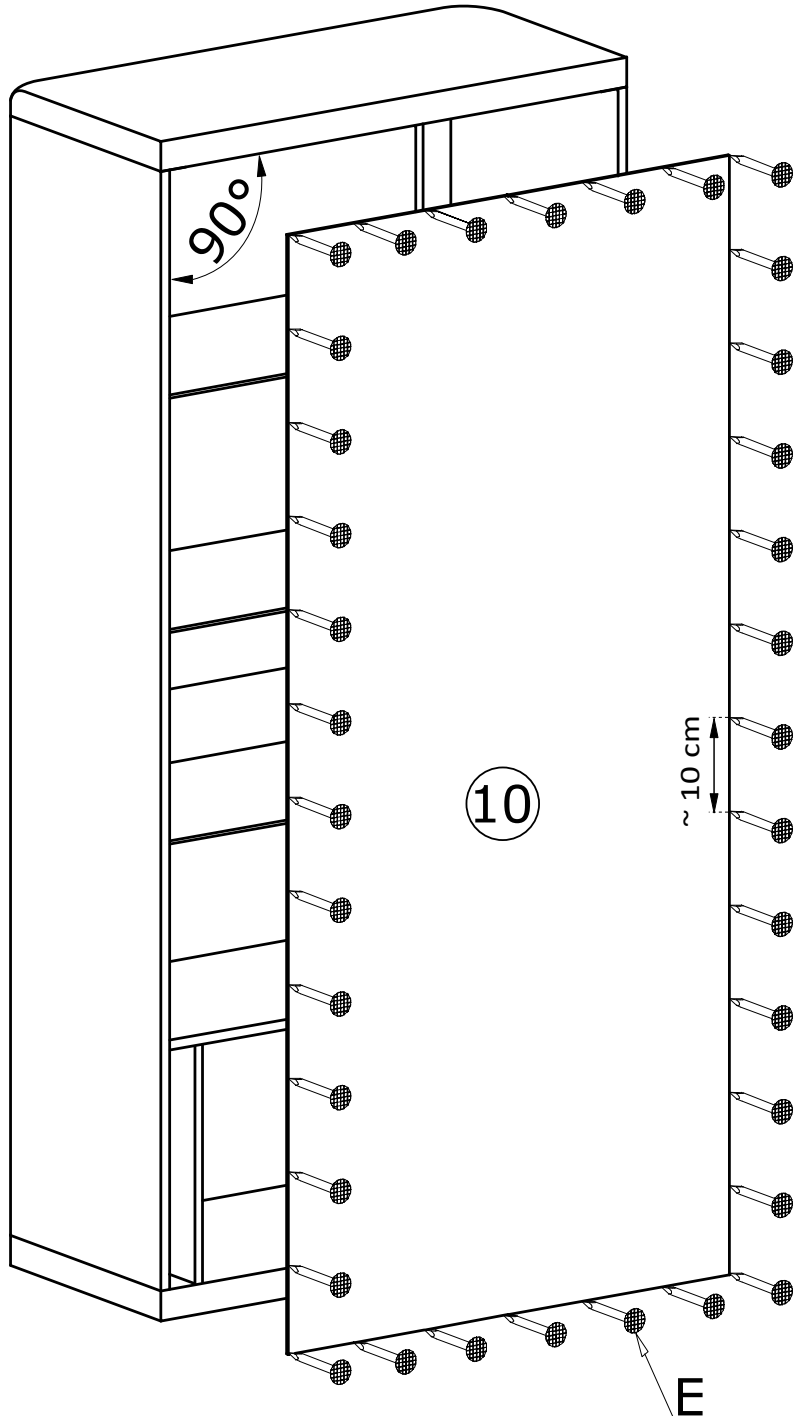

IV

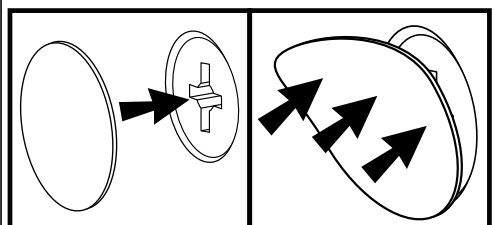
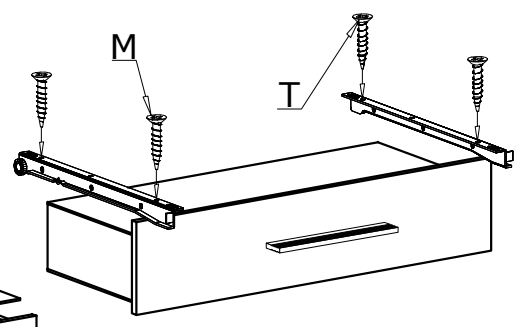
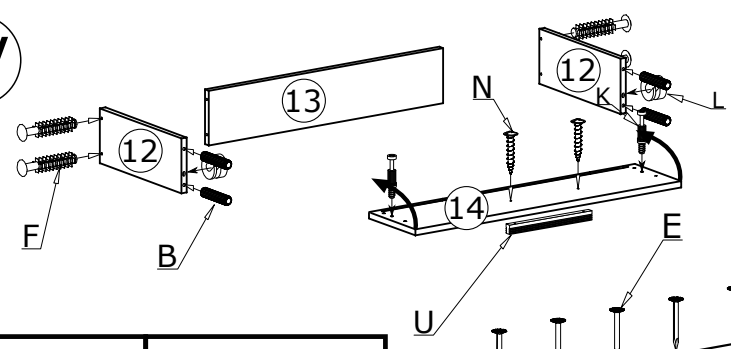

V

