

DALLAS 17

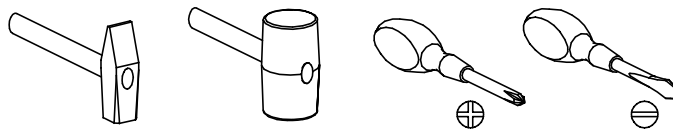

Narzędzia potrzebne do montażu



UWAGA !!!

MONTOWANIE USZKODZONYCH
ELEMENTÓW POWODUJE UTRATĘ
GWARANCJI

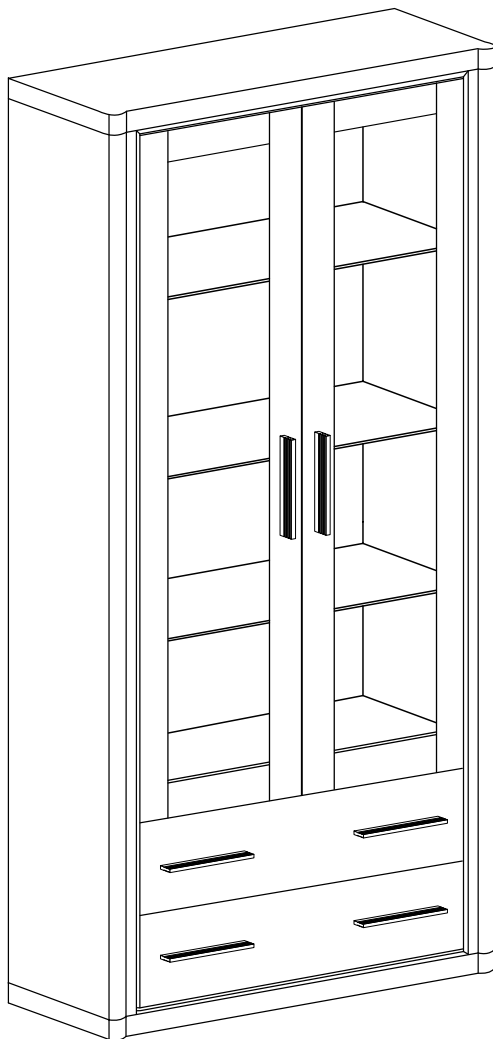

Nr	D[mm]	S[mm]	G[mm]	Ilość
1	970	450	48	1
2	970	450	48	1
3	930	25	16	2
4	1810	422	16	1
5	1810	422	16	1
6	1810	100	32	1
7	1810	100	32	1
8	395	405	16	1
9	395	405	16	1
10	935	405	16	1
11	1835	960	2,5	1
12	770	190	16	2
13	400	150	16	2
14	400	150	16	2
15	695	150	16	2
16	725	405	2,5	2
17	1430	385	16	2
18	933	350	4	3
19	935	80	16	1



X2 - 8 St.



X1 - 20 St.

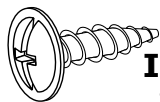

I - 2 St.
3,5x16 mm

W przypadku reklamacji proszę podać numer pakowacza znajdujący się na kartonie.

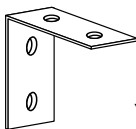

Y - 1 St.

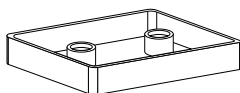

A - 4 St.

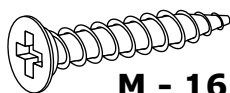

M - 16 St.
3,9x25 mm

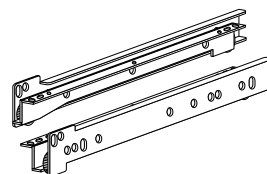

T - 2 Kpl.

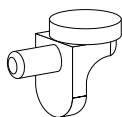

P - 12 St.

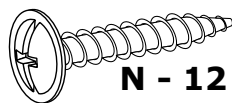

N - 12 St.
4x27 mm

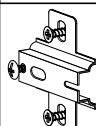

C - 6 St.

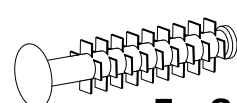

F - 8 St.



U - 6 St.

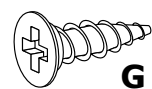

G - 12 St.
3,5x16 mm

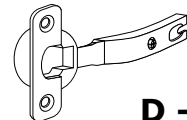

D - 6 St.

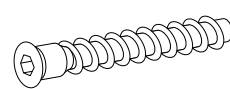

W - 8 St.

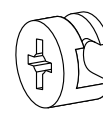

L - 20 St.



E - 60 St.

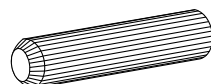

B - 24 St.

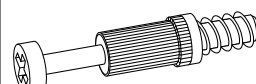

K - 20 St.

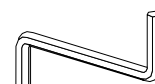

Z - 1 St.

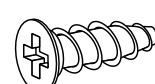

J - 8 St.
5x13 mm

I

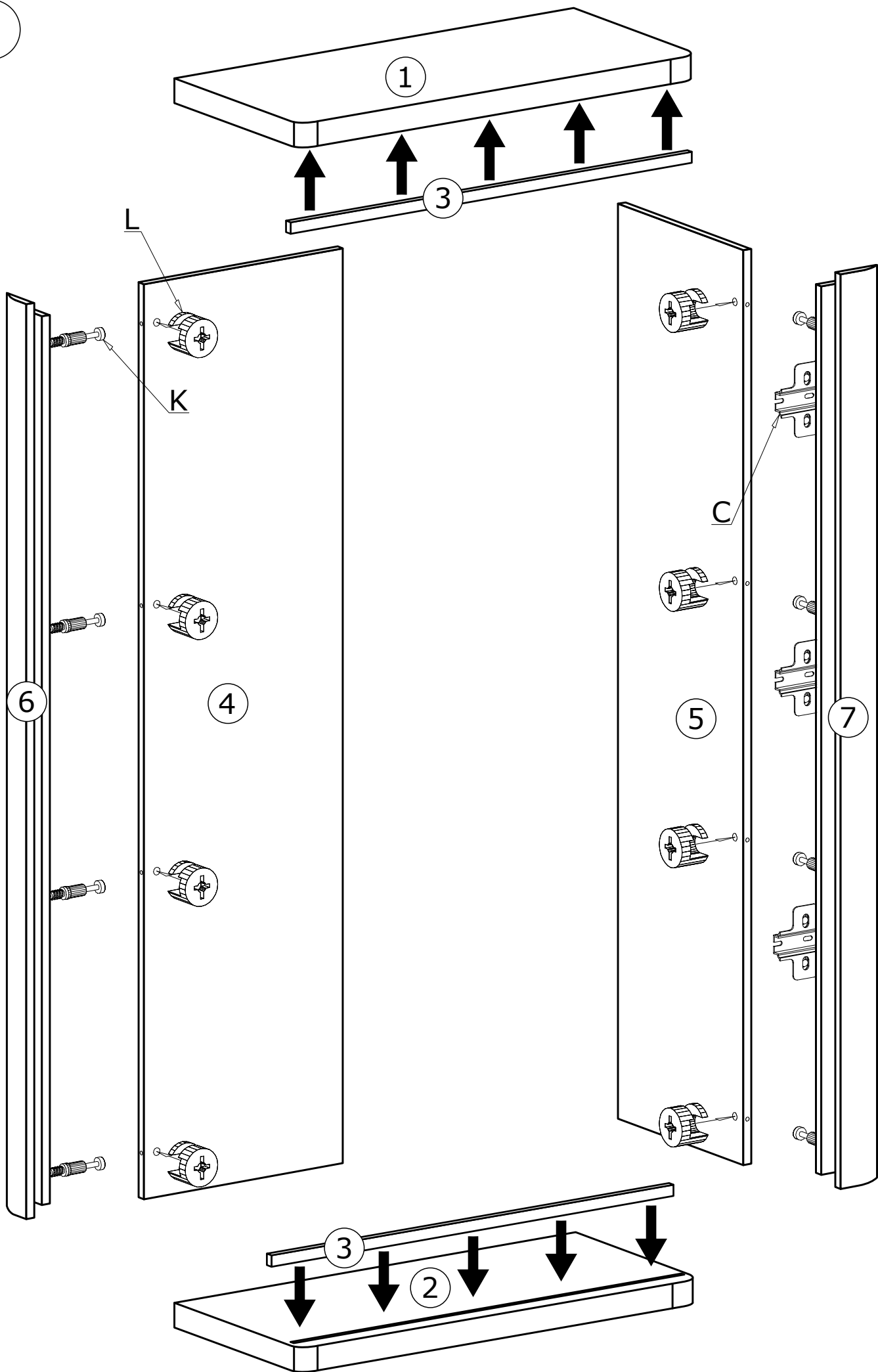

III

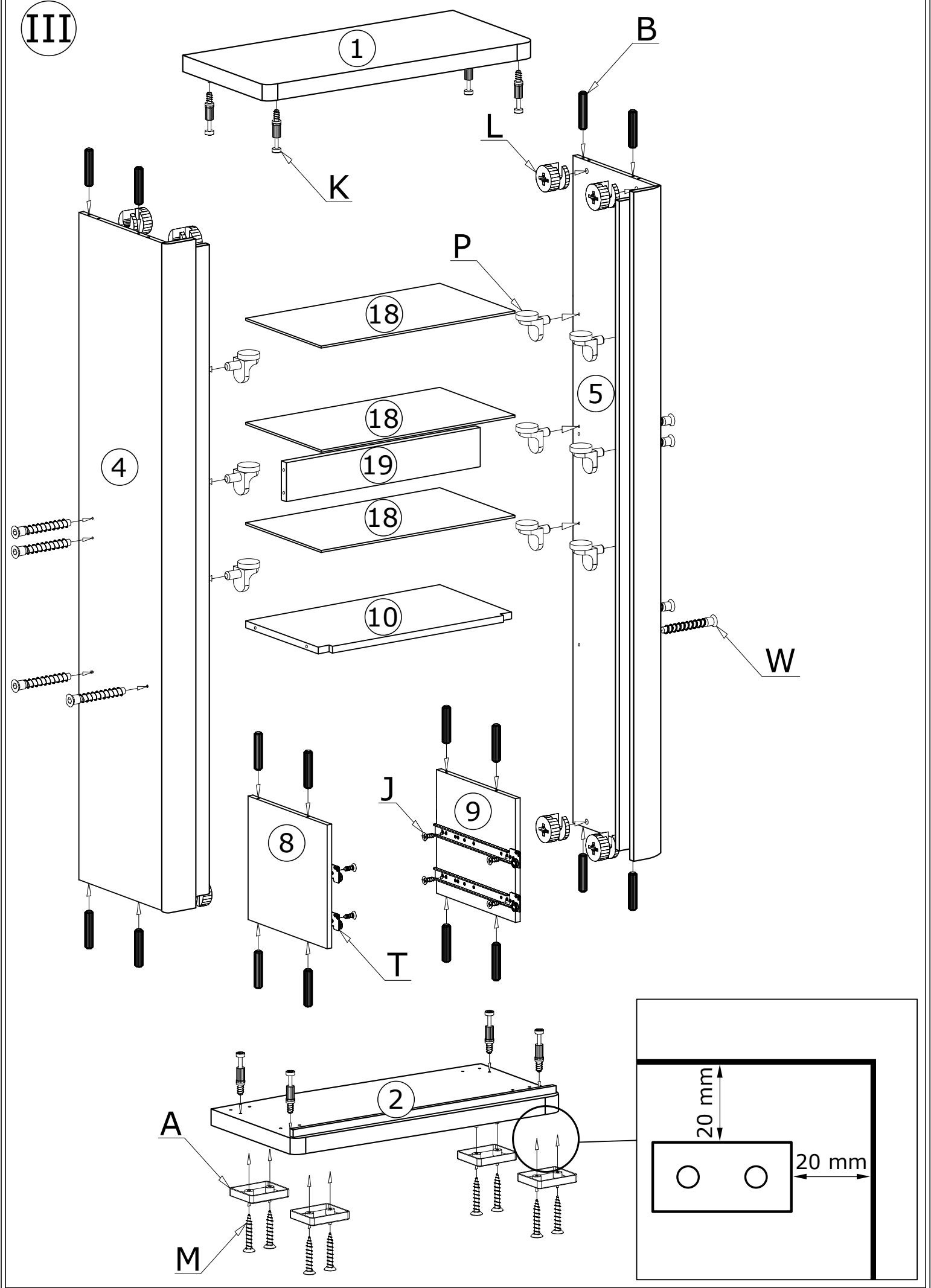

III

60X 

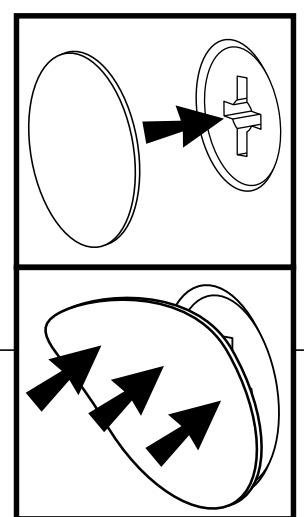
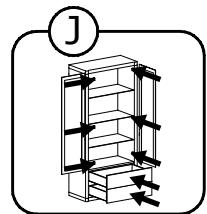
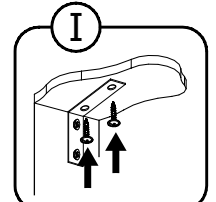
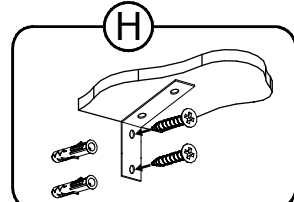
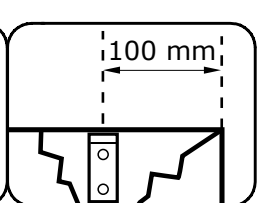
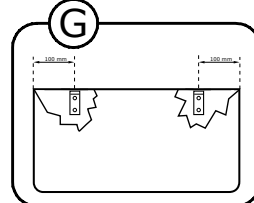
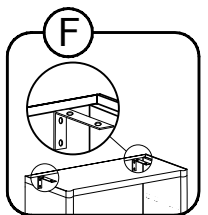
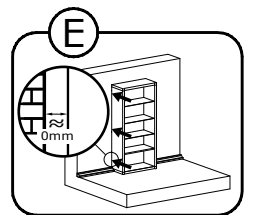
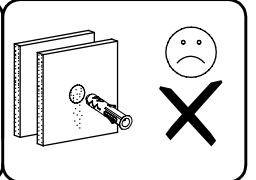
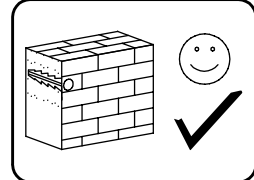
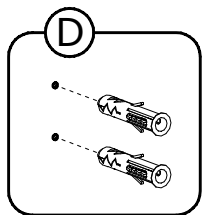
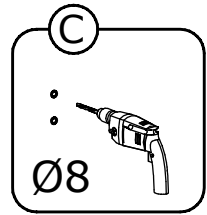
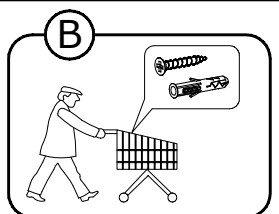
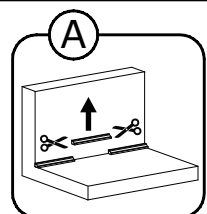
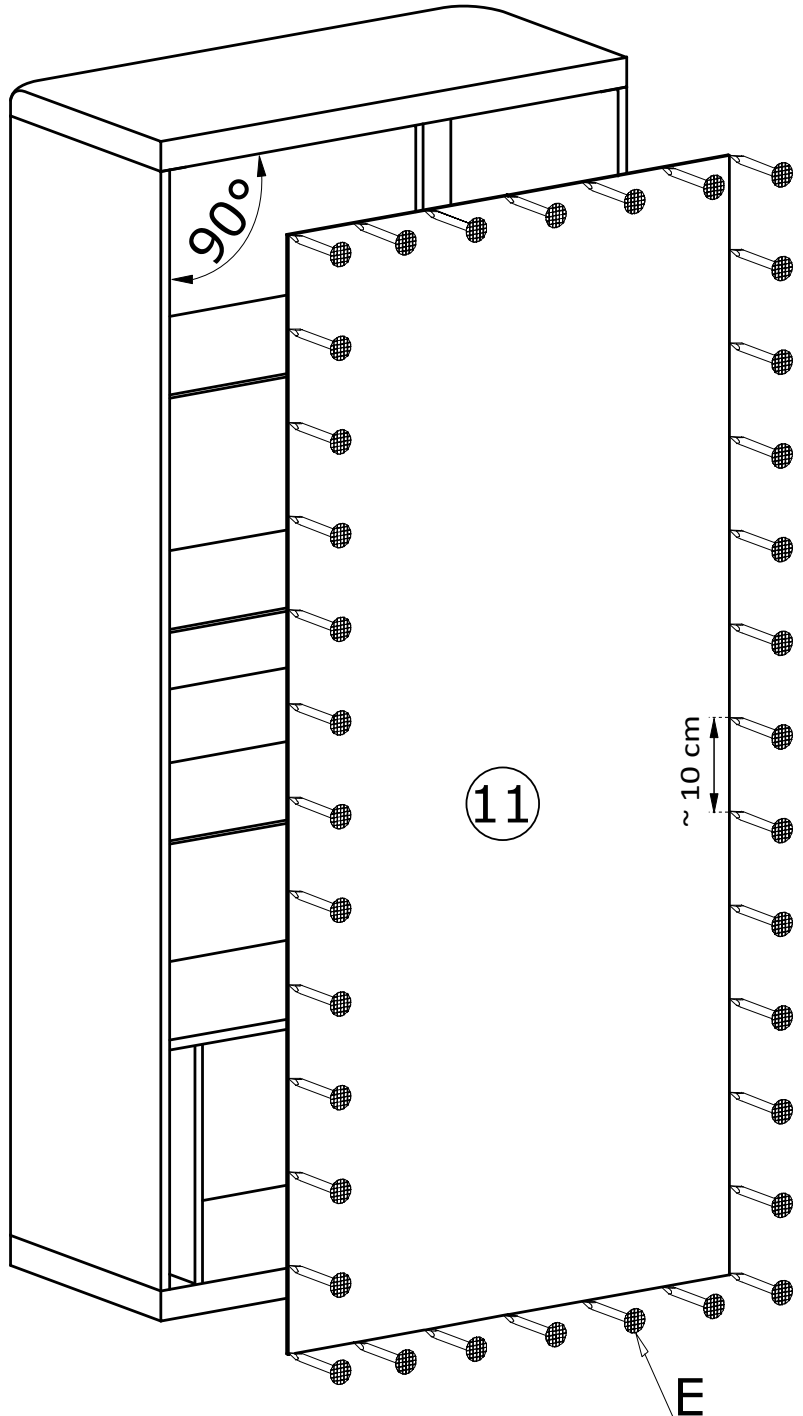

IV

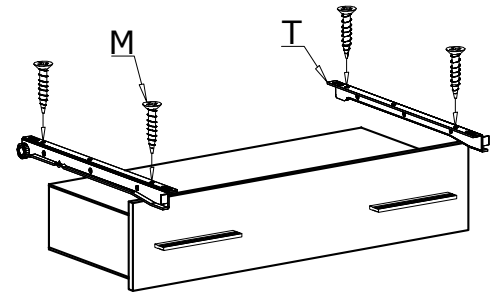
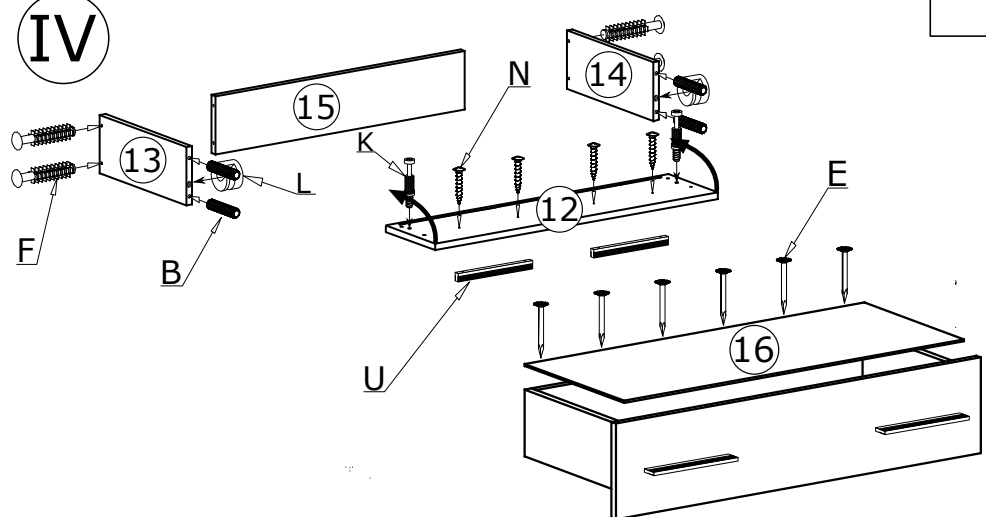

V

