

# DALLAS 13

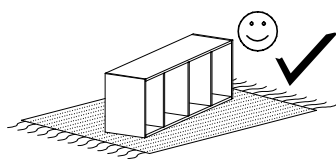

Narzędzia potrzebne do montażu



## UWAGA !!!

MONTOWANIE USZKODZONYCH  
ELEMENTÓW POWODUJE UTRATĘ  
GWARANCJI

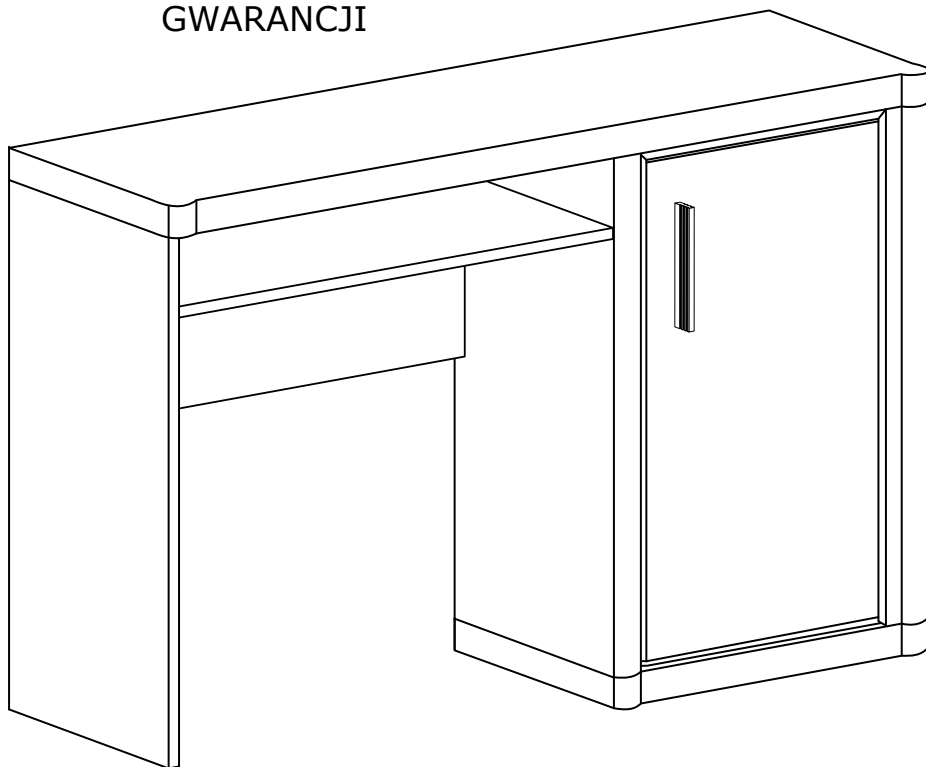

Nr	D[mm]	S[mm]	G[mm]	Ilość
1	1260	610	48	1
2	480	610	48	1
3	440	25	16	2
4	702	566	16	1
5	670	583	16	1
6	670	100	32	1
7	670	100	32	1
8	520	446	16	1
9	725	566	16	1
10	763	260	16	1
11	730	470	2,5	1
12	738	400	16	1
13	645	380	16	1

W przypadku reklamacji proszę podać numer pakowacza znajdujący się na kartonie.

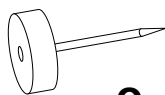

**O - 2 St.**

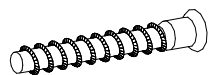

**W - 4 St.**

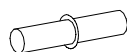

**P - 4 St.**



**M - 8 St.**  
4x25 mm

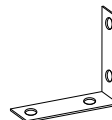

**Y - 2 St.**

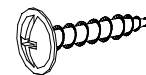

**I - 4 St.**  
3,5x16 mm

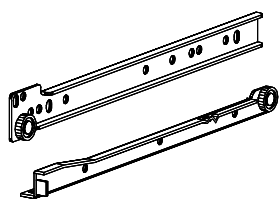

**T - 1 Kpl.**



**N - 2 St.**  
4x30 mm

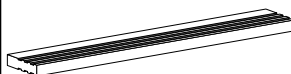

**U - 1 St.**

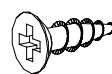

**G - 8 St.**  
3,5x16 mm



**L - 13 St.**



**E - 20 St.**

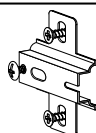

**C - 2 St.**

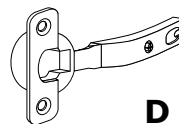

**D - 2 St.**



**S - 1 St.**



**A - 4 St.**



**B - 10 St.**

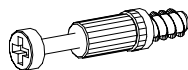

**K - 13 St.**

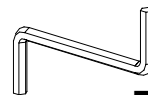

**Z - 1 St.**



**J - 4 St.**  
5x13 mm



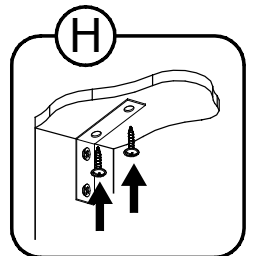
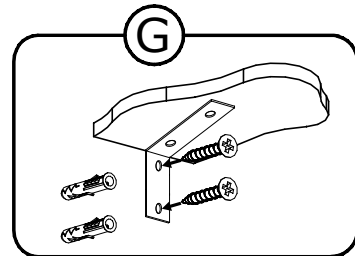
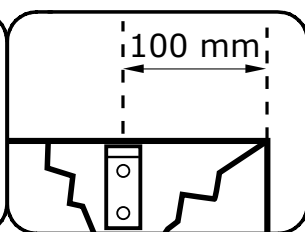
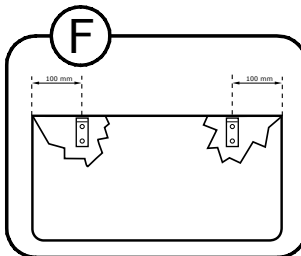
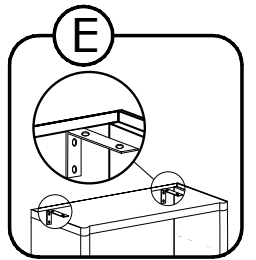
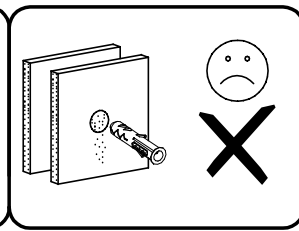
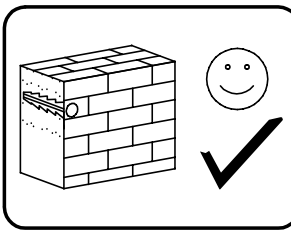
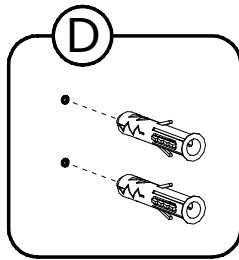
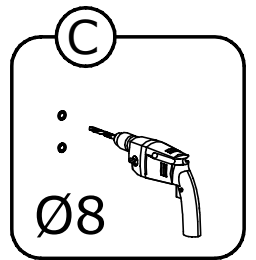
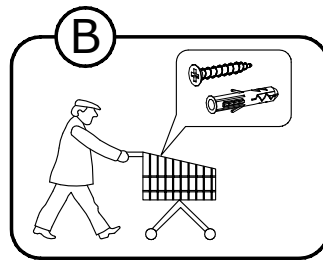
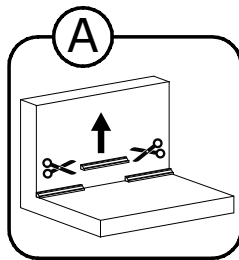
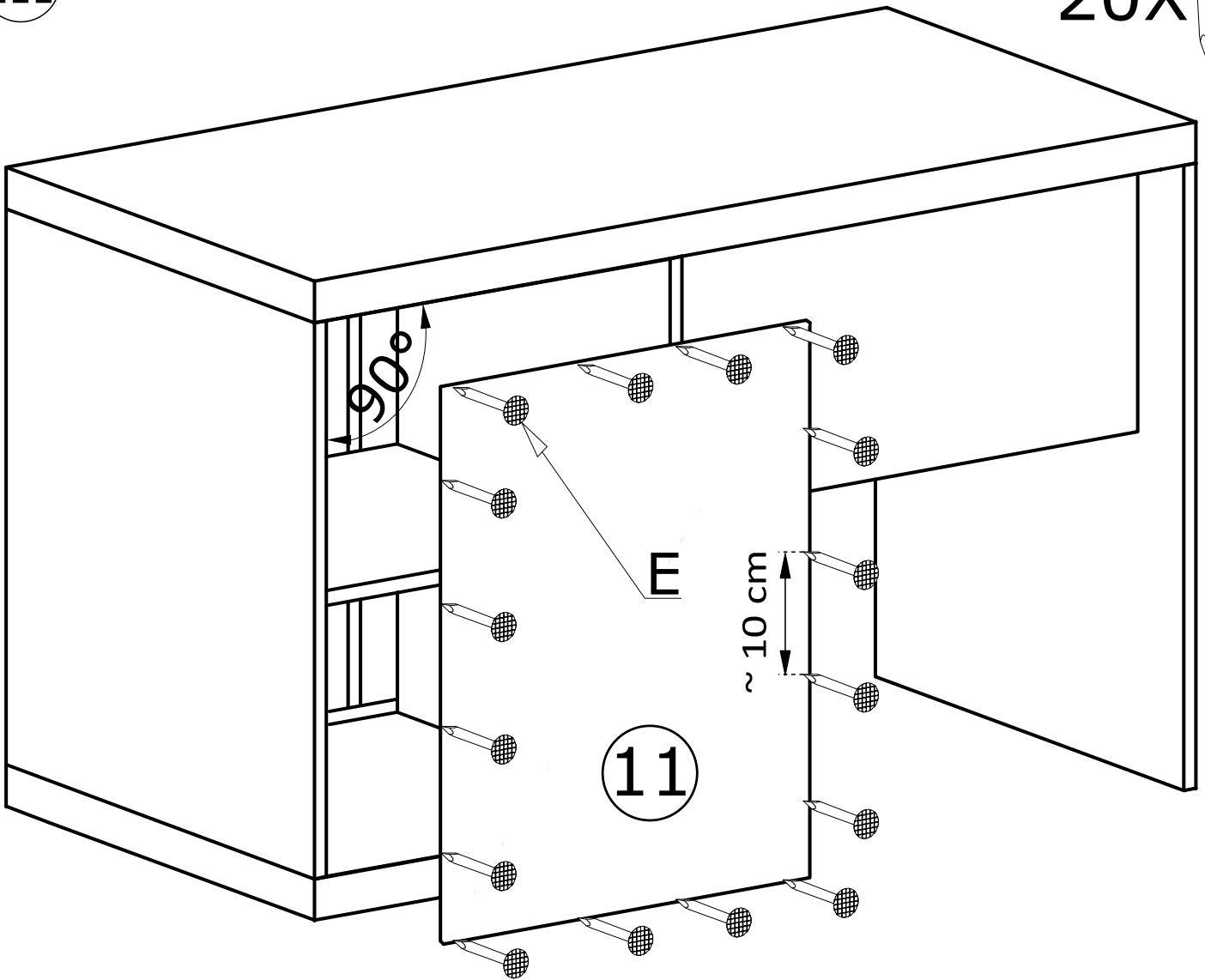

IV

