

DALLAS 2

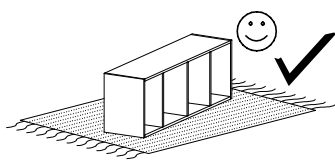

Narzędzia potrzebne do montażu



UWAGA !!!

MONTOWANIE USZKODZONYCH
ELEMENTÓW POWODUJE UTRATĘ
GWARANCJI

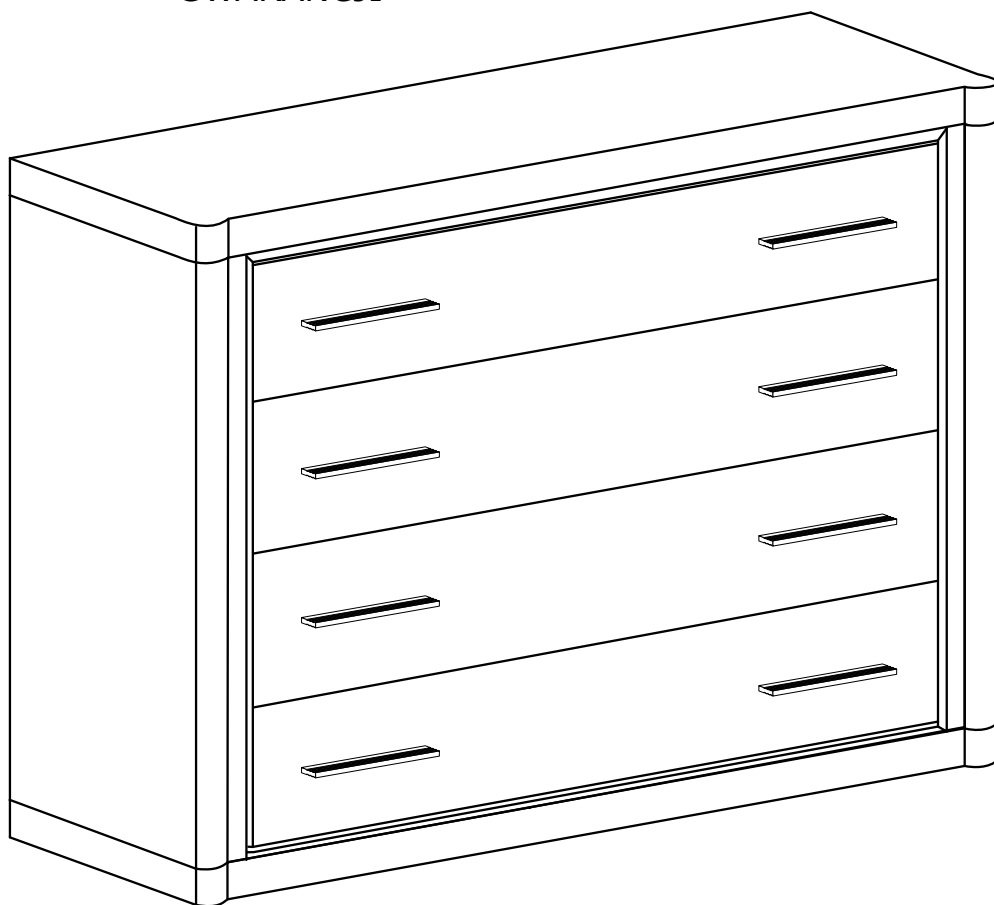

Nr	D[mm]	S[mm]	G[mm]	Ilość
1	1070	450	48	1
2	1070	450	48	1
3	1030	25	16	2
4	800	422	16	1
5	800	422	16	1
6	800	100	32	1
7	800	100	32	1
8	800	405	16	1
9	800	405	16	1
10	1062	1056	2,5	1
11	826	405	2,5	4
12	872	190	16	4
13	400	150	16	4
14	400	150	16	4
15	796	150	16	4

W przypadku reklamacji proszę podać numer pakowacza znajdujący się na kartonie.

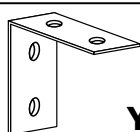

Y - 1 St.

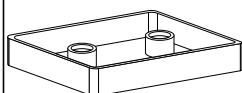

A - 4 St.

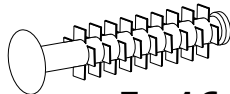

F - 16 St.

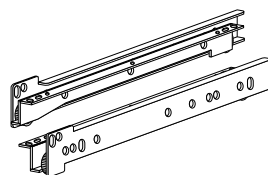

T - 4 Kpl.



X1 - 22 St.

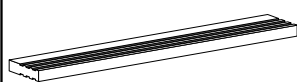

U - 8 St.

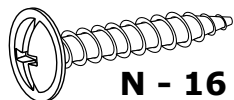

N - 16 St.
4x27 mm

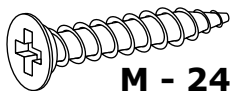

M - 24 St.
3,9x25 mm

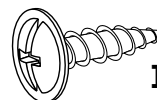

I - 2 St.
3,5x16 mm



L - 22 St.

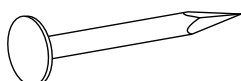

E - 70 St.

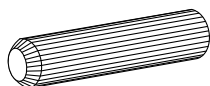

B - 32 St.

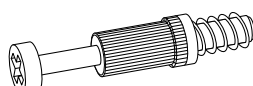

K - 22 St.



Z - 1 St.

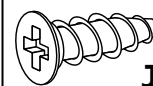

J - 16 St.
5x13 mm

I

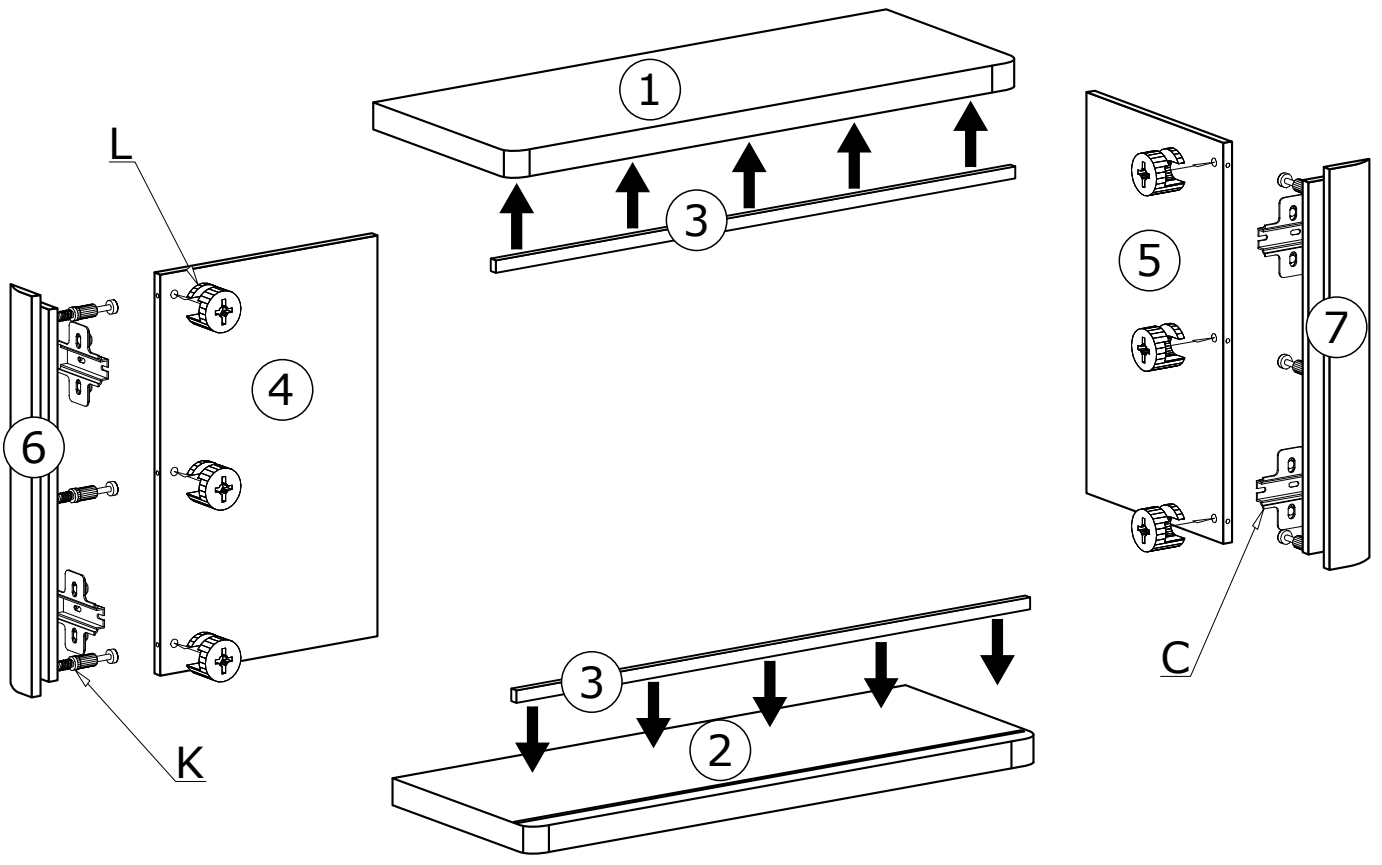

II

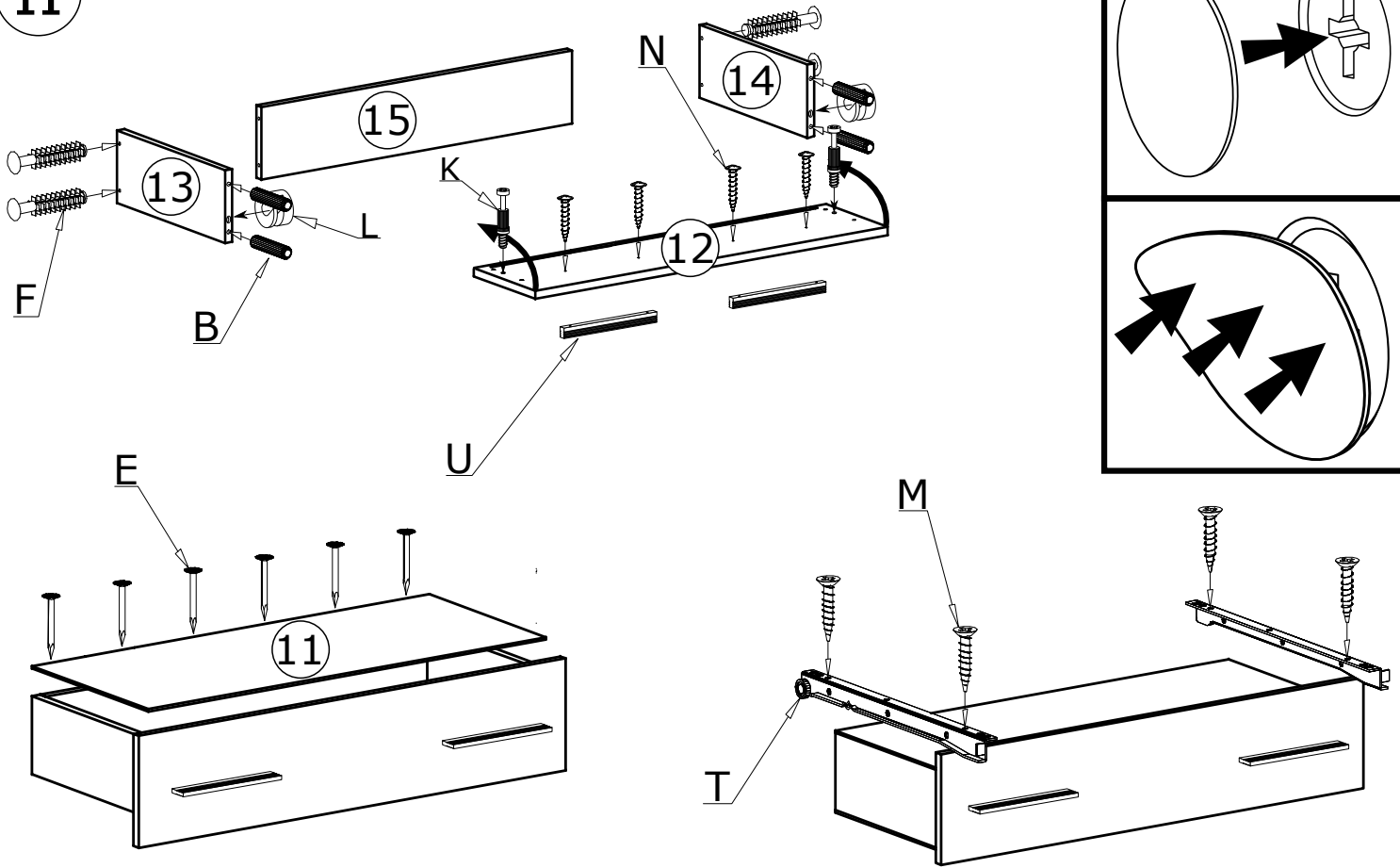

III

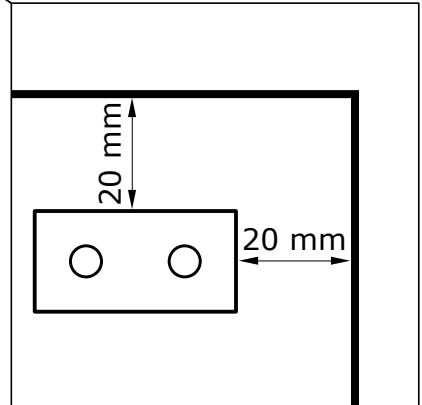
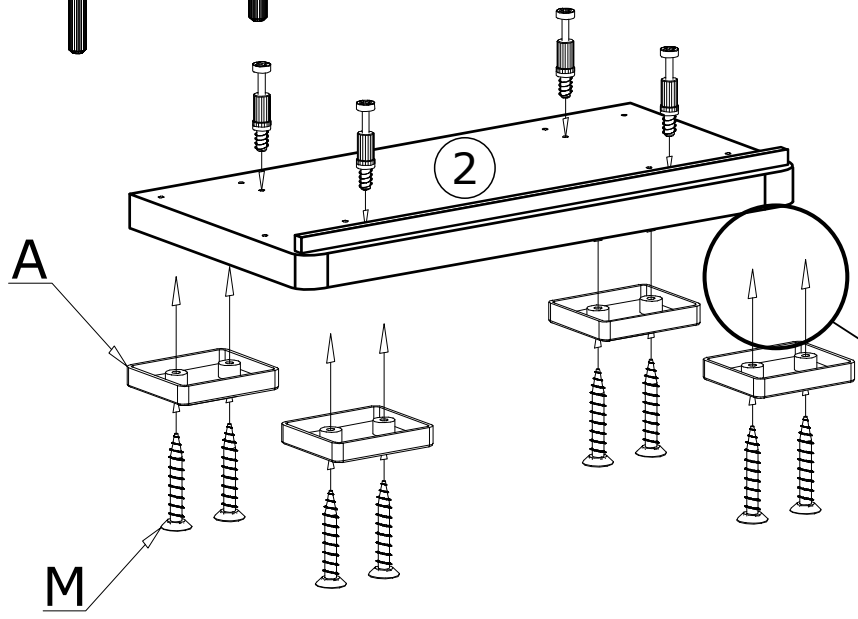
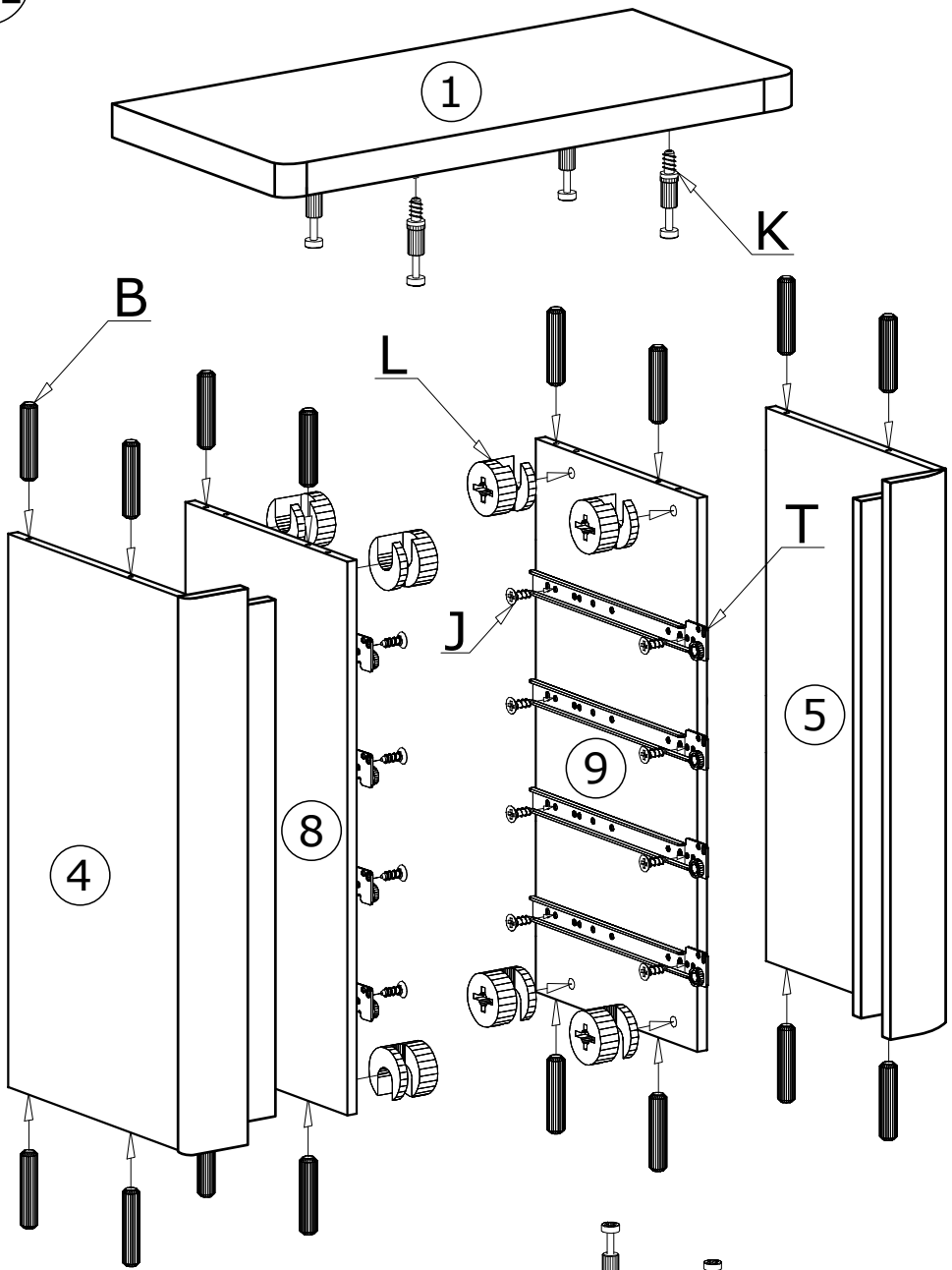

IV

70X 

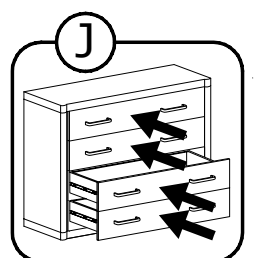
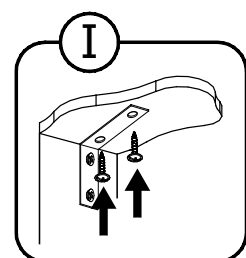
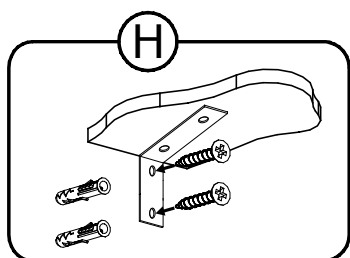
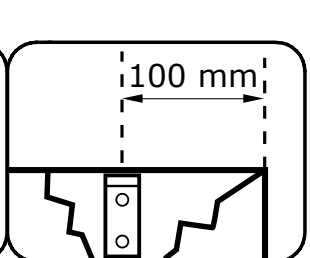
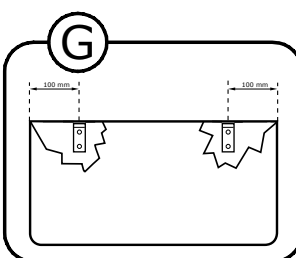
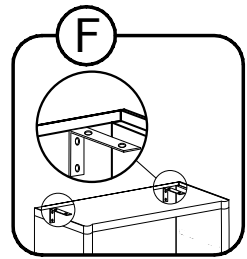
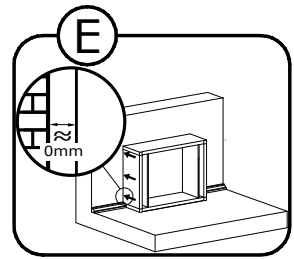
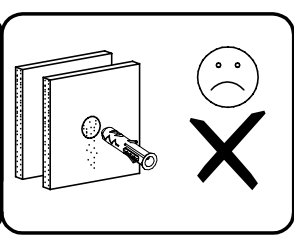
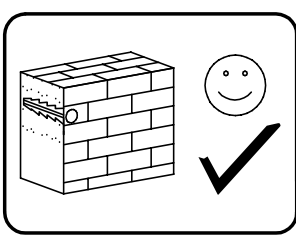
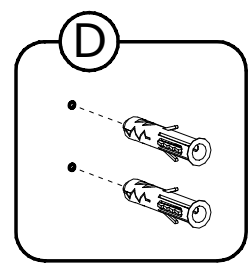
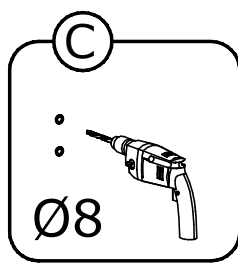
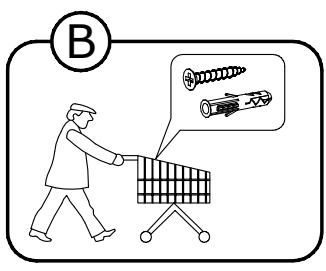
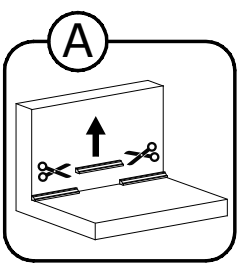
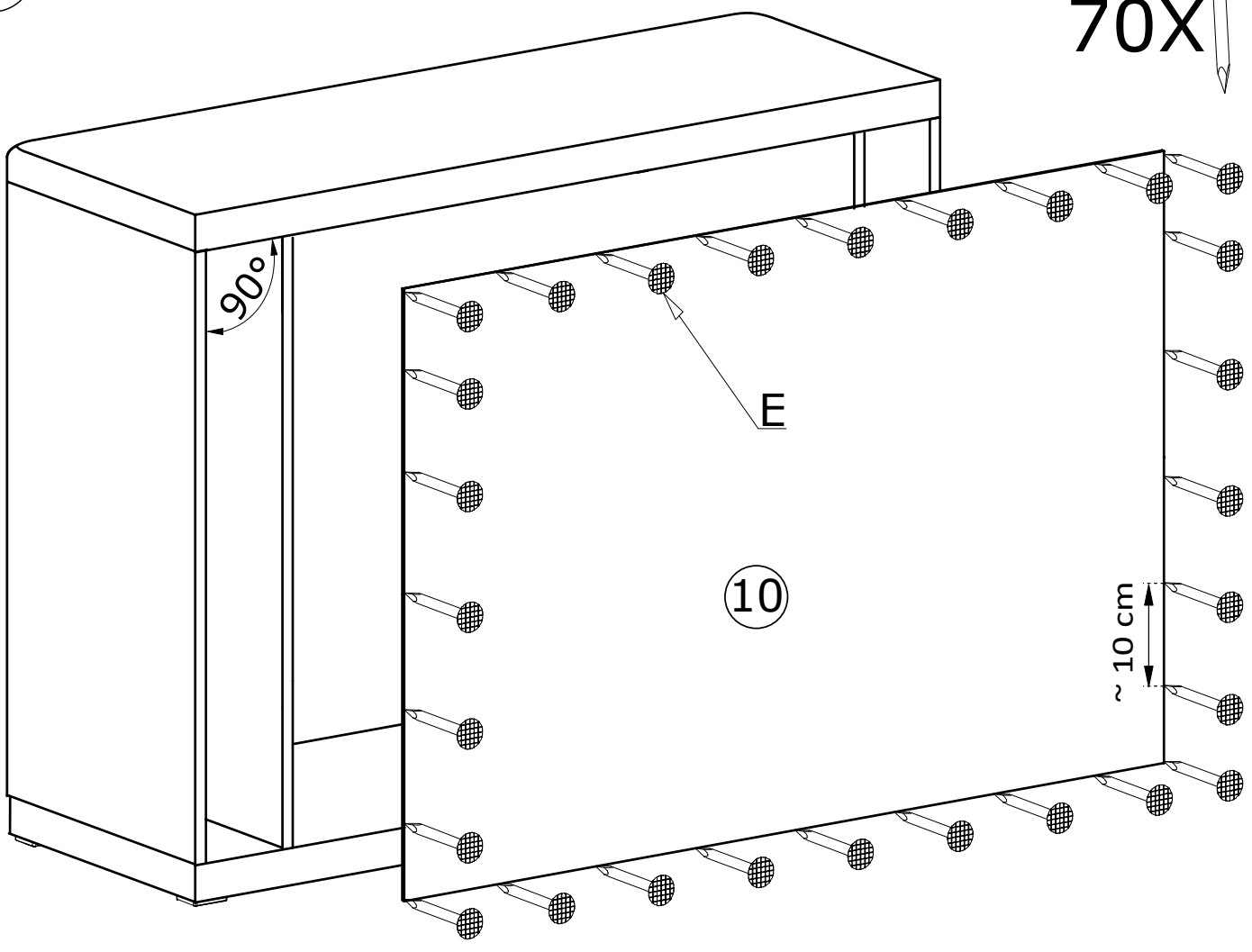

V

