

CALI 3

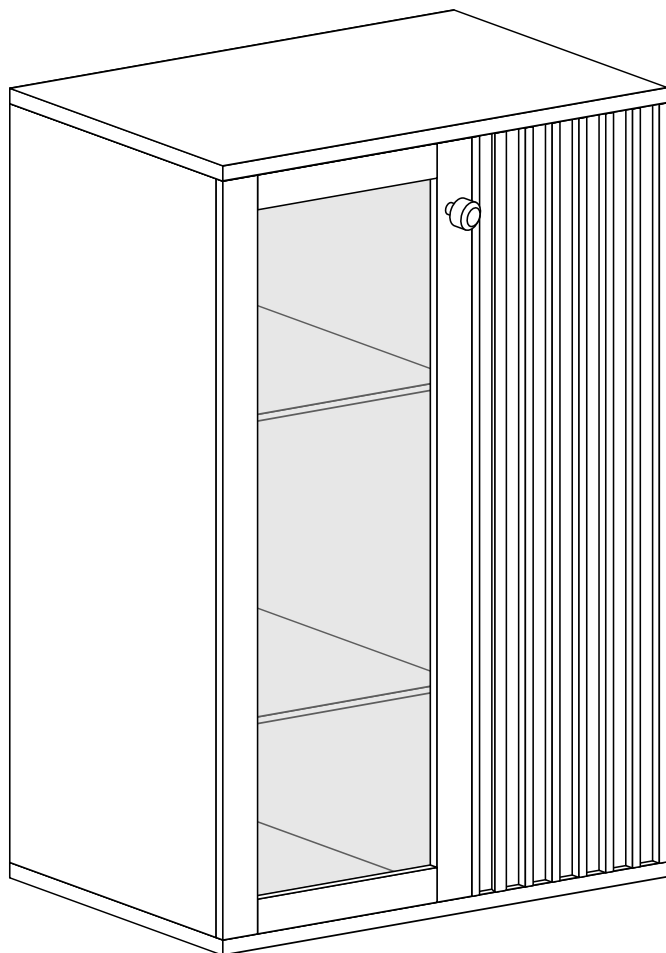

Narzędzia potrzebne do montażu



Nr	Nazwa elementu	D[mm]	S[mm]	G[mm]	Ilość
1	Bok Lewy	1245	386	16	1
2	Bok Prawy	1245	370	16	1
3	Błat Górny	864	406	32	1
4	Błat Dolny	864	406	32	1
5	Przegroda	1245	386	16	1
6	Półka Duża	452	370	16	2
7	Półka Mała	342	370	16	2
8	Kapak	1285	364	2,5	1
9	Kapak	1285	472	2,5	1
10	Drzwi z Szybą	1239	483	16	1
11	Drzwi z Lamelami	1239	356	32	1

UWAGA !!!

MONTOWANIE USZKODZONYCH
ELEMENTÓW POWODUJE UTRATĘ
GWARANCJI

W przypadku reklamacji proszę podać numer pakowacza znajdujący się na kartonie.

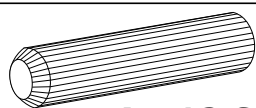

A - 12 St.

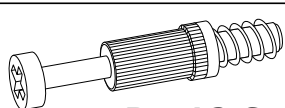

B - 12 St.

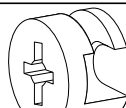

C - 12 St.

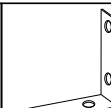

Y1 - 1 St.



X1 - 12 St.

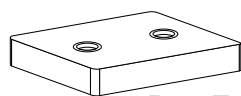

D - 5 St.

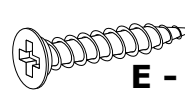

E - 10 St.
3,5x25 mm

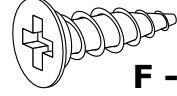

F - 21 St.
3,5x16 mm

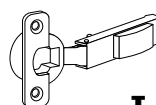

I - 6 St.

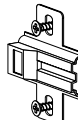

J - 6 St.



K - 16 St.

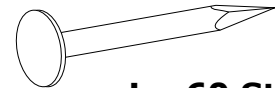

L - 60 St.

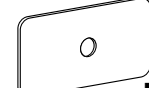

M - 9 St.

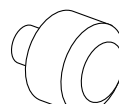

N - 1 St.

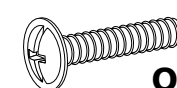

O - 1 St.
3,5x20 mm

I

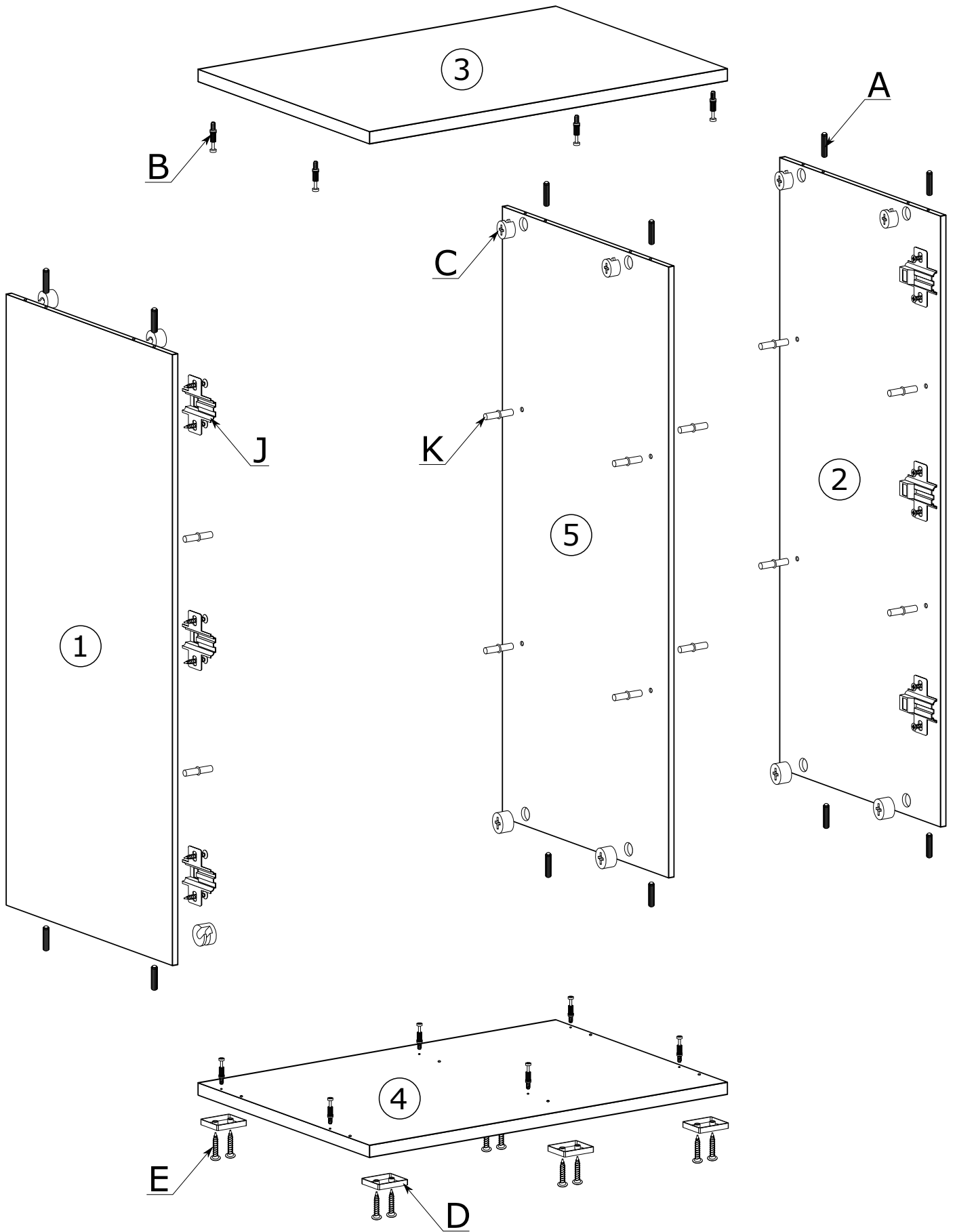

II

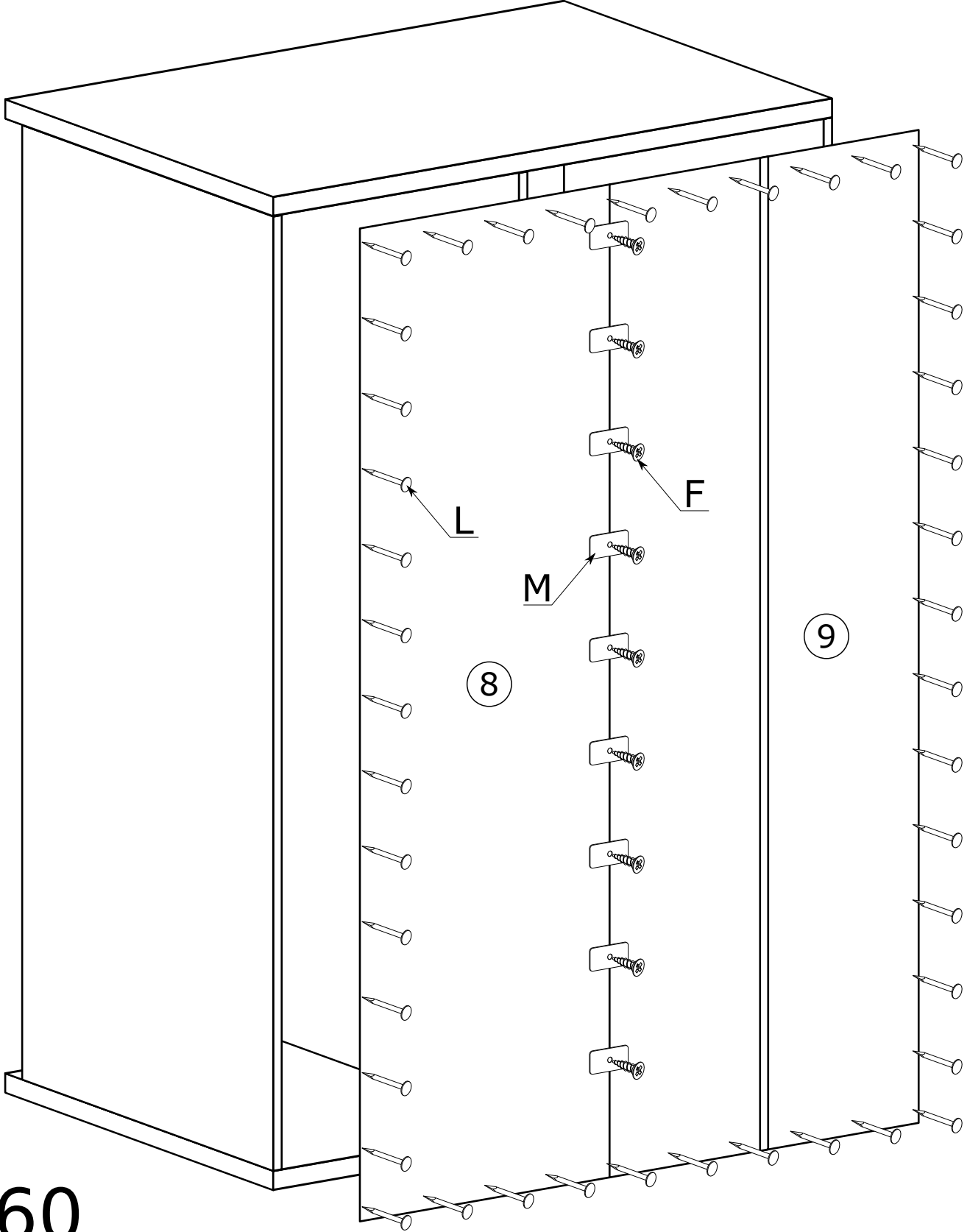

x60

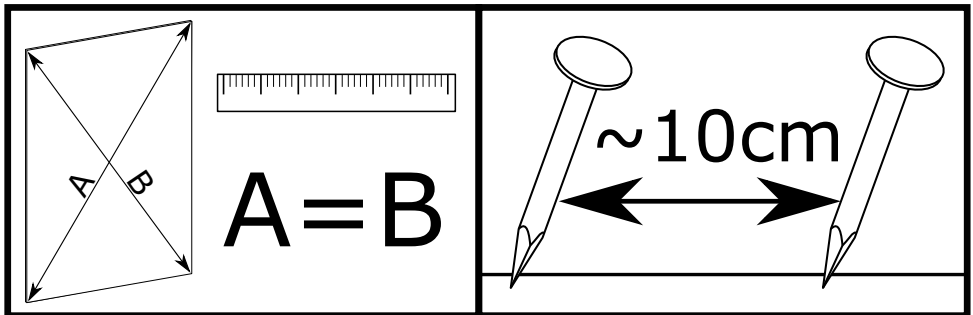
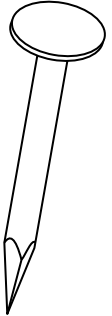

III

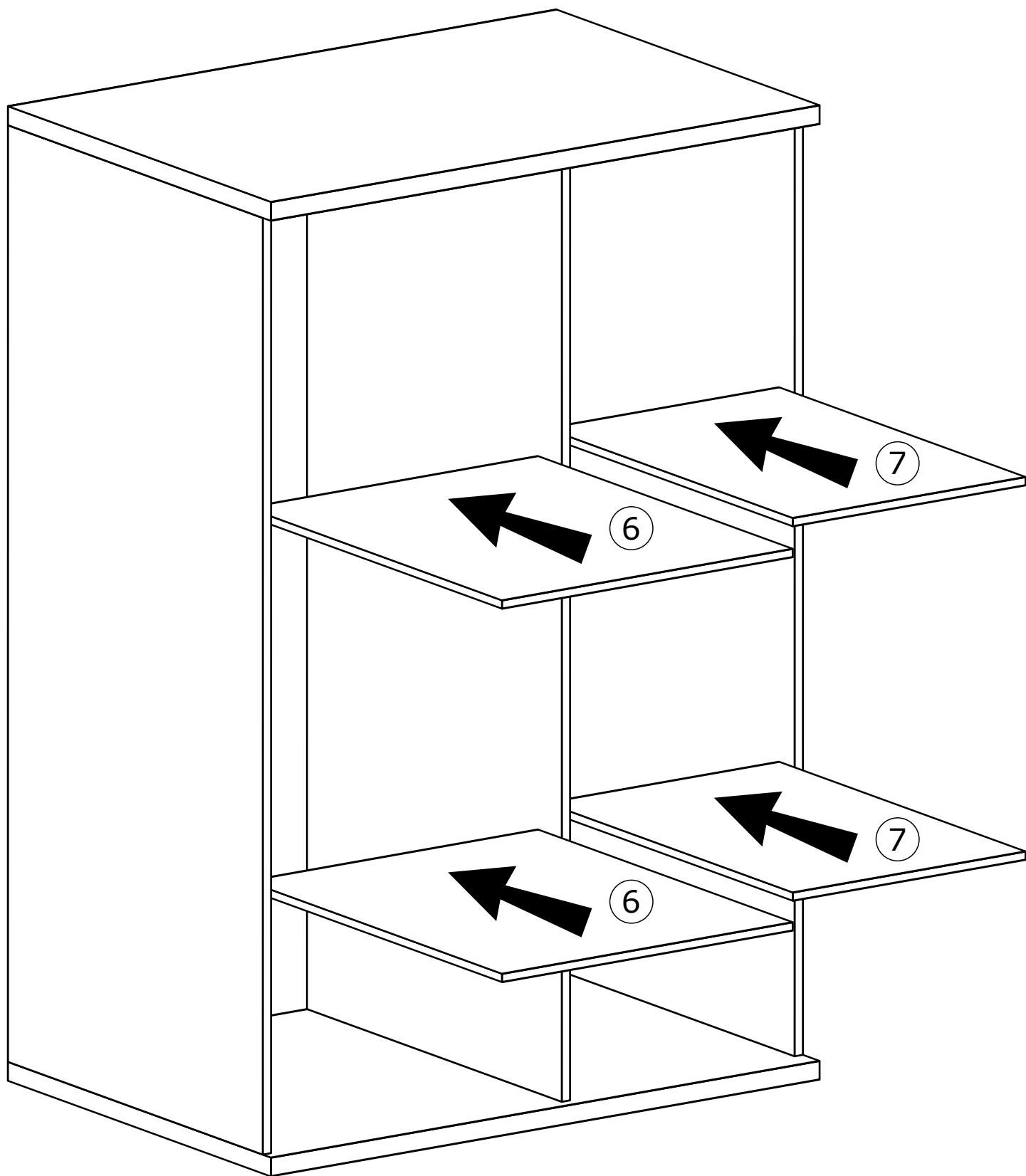

IV

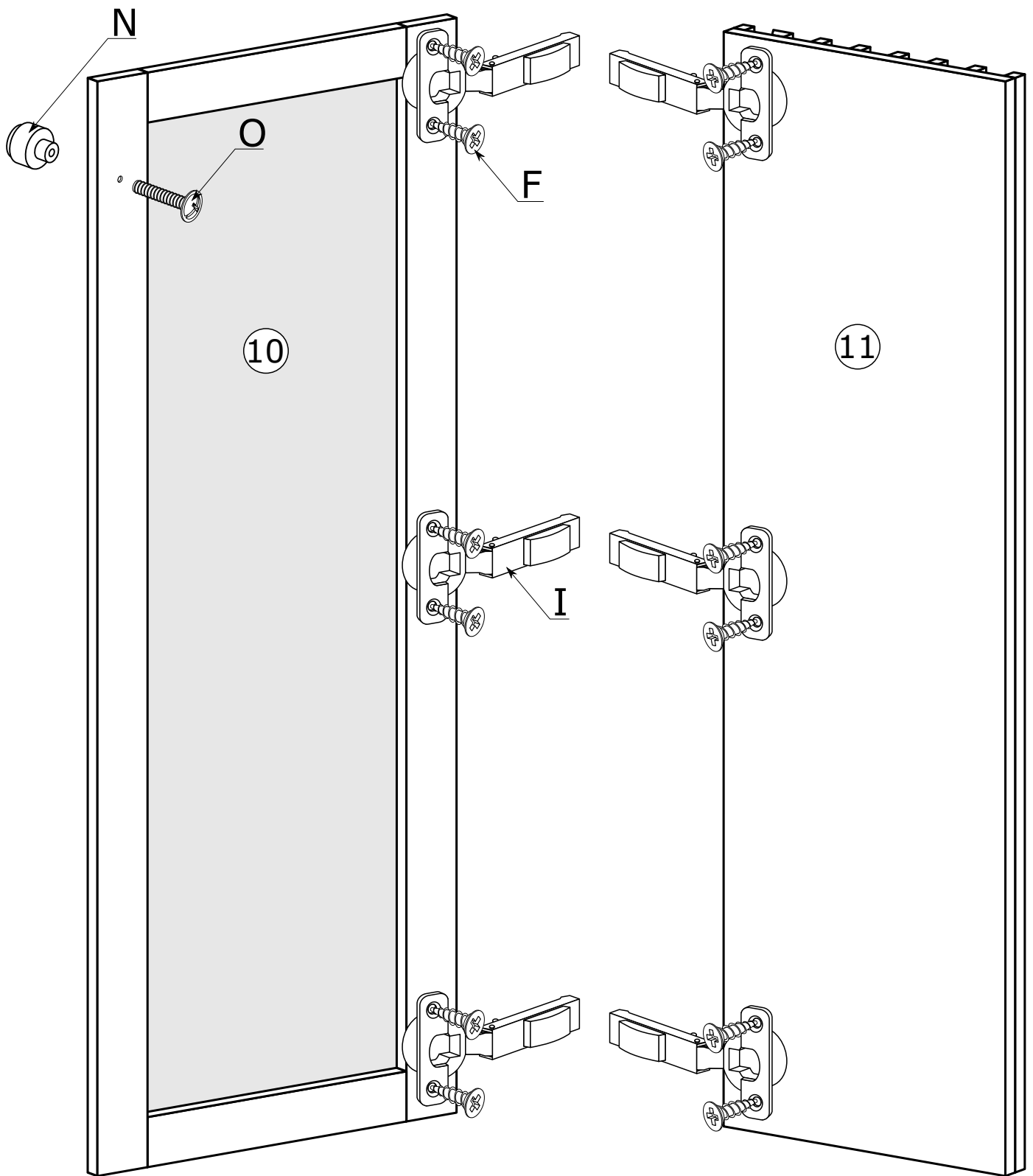

V

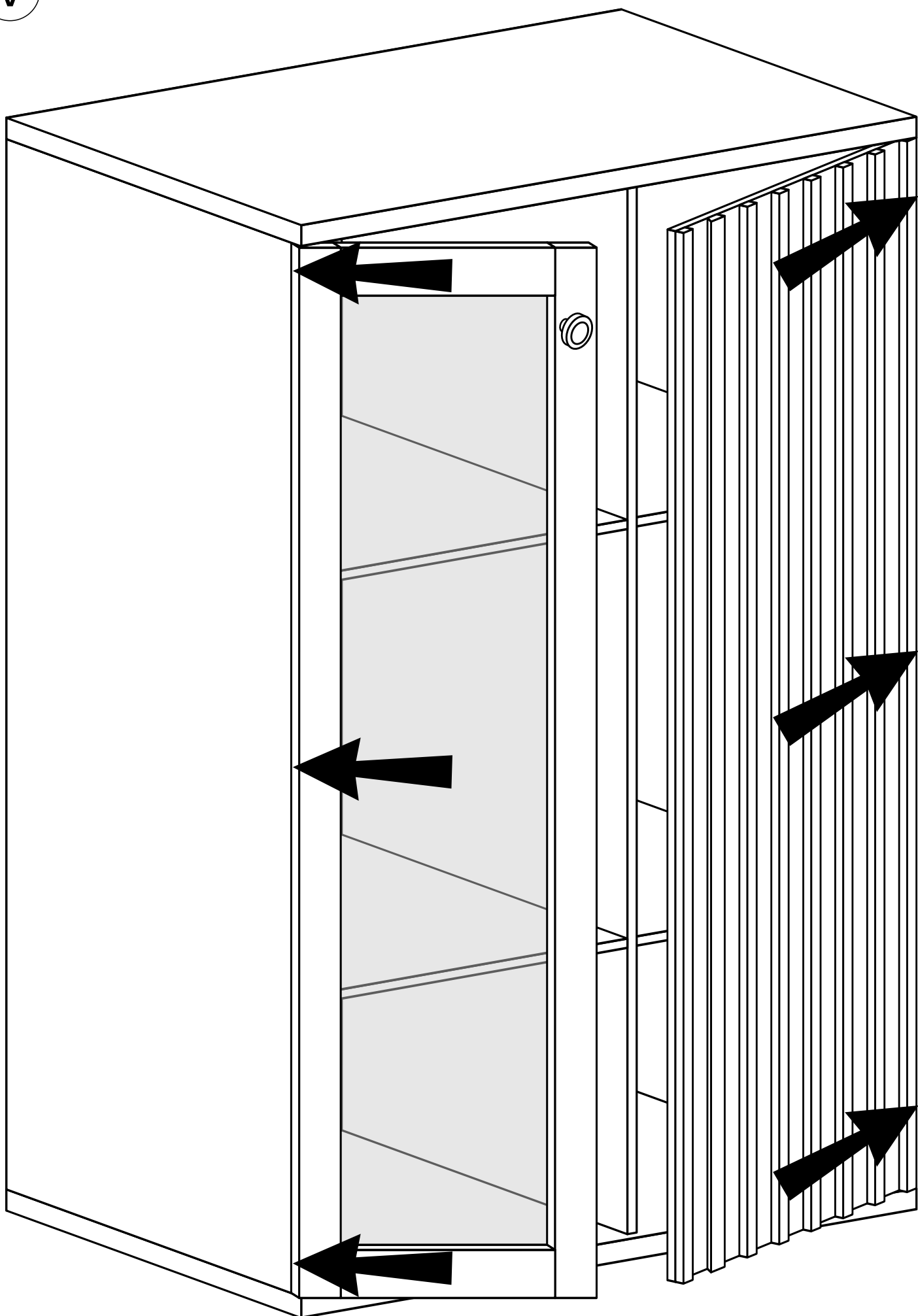

MONTAŻ KĄTOWNIKA

