

APOLLO 14

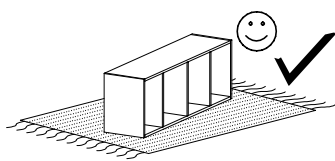

Narzędzia potrzebne do montażu



UWAGA !!!
 MONTOWANIE USZKODZONYCH
 ELEMENTÓW POWODUJE UTRATĘ
 GWARANCJI

Nr	D[mm]	S[mm]	G[mm]	Ilość
1	857	557	16	1
2	898	598	32	1
3	560	100	16	2
4	560	100	16	2
5	560	85	16	4

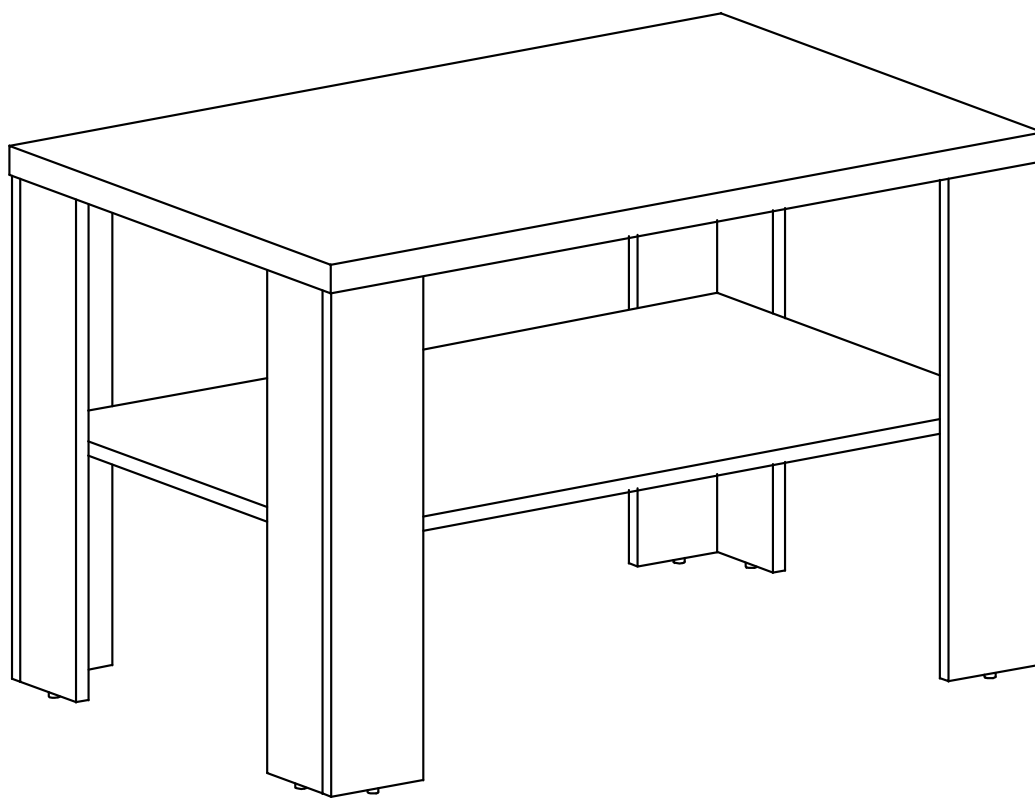

W przypadku reklamacji proszę podać numer pakowacza znajdujący się na kartonie.

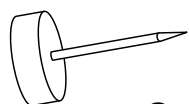

Q - 8 St.

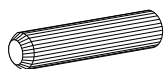

B - 20 St.

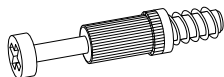

K - 12 St.



X1 - 12 St.

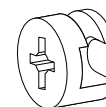

L - 12 St.

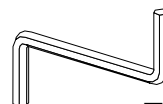

Z - 1 St.



S - 2 St.

I

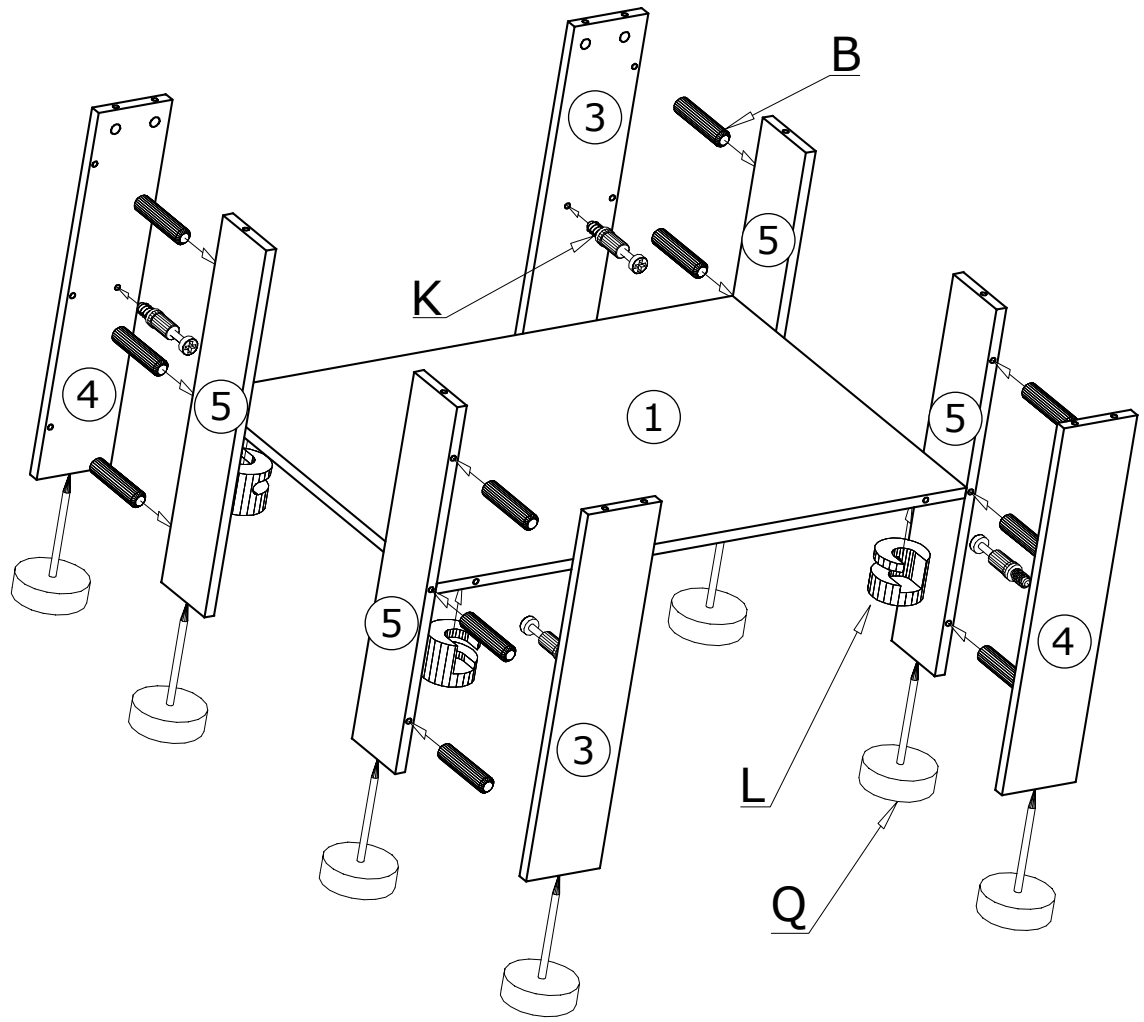

II

