

ANTICA 10

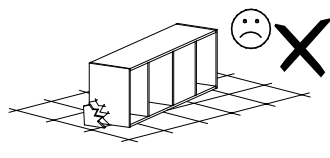

Narzędzia potrzebne do montażu

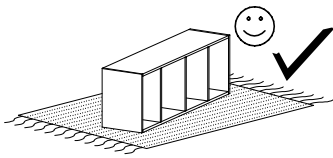
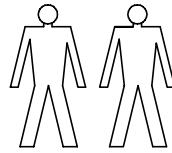
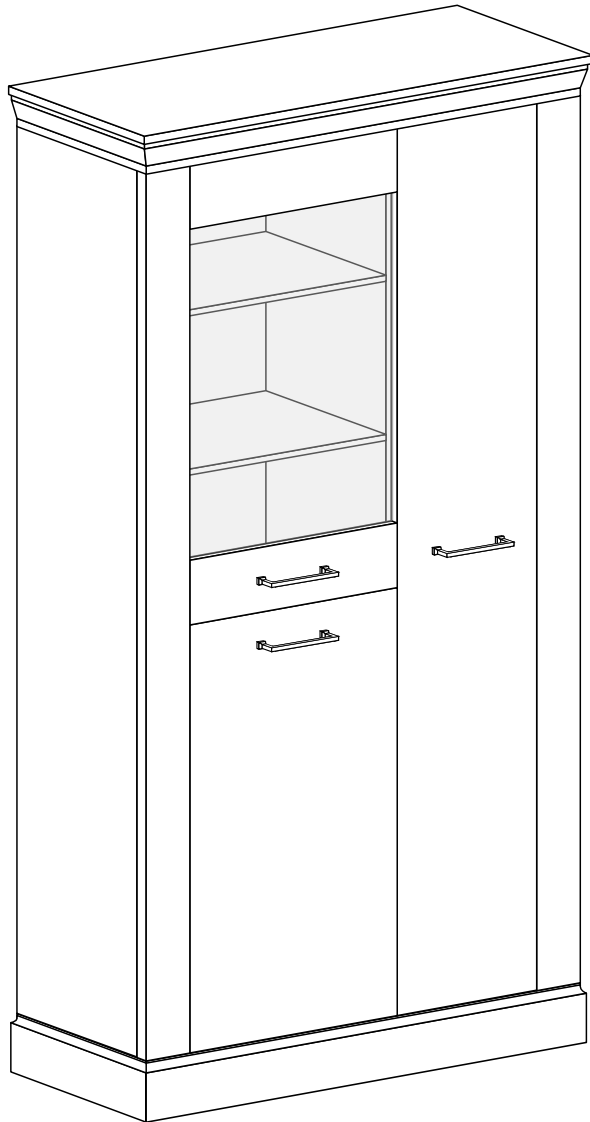
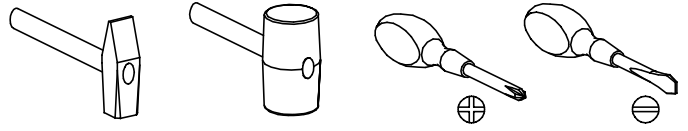

Nr	Nazwa elementu	D[mm]	S[mm]	G[mm]	Ilość
1	Bok P/L	1865	380	16	2
2	Blat Górny	970	420	71	1
3	Blat Dolny	942	410	100	1
4	Przegroda	1865	363	16	1
5	Wieniec	482	364	16	1
6	Listwa P/L	1862	100	32	2
7	Półka	380	364	16	4
8	Półka	482	350	16	2
9	Półka	482	364	16	1
10	Kapak	1892	398	2,5	1
11	Kapak	1892	500	2,5	1
12	Listwa	714	55	16	1
13	Drzwi G/D	400	120	16	2
14	Drzwi	1800	300	16	1
15	Drzwi	838	400	16	1
16	Drzwi Szyba	760	393	4	1

UWAGA !!!

MONTOWANIE USZKODZONYCH
ELEMENTÓW POWODUJE UTRATĘ
GWARANCJI

W przypadku reklamacji proszę podać numer pakowacza znajdujący się na kartonie.

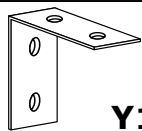

Y1 - 1 St.

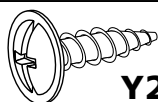

Y2 - 2 St.
3,5x16 mm

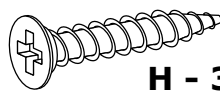

H - 3 St.
3,9x30 mm



X1 - 26 St.



F - 6 St.

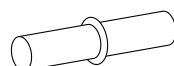

P - 28 St.

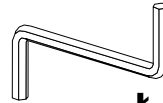

Ł - 1 St.

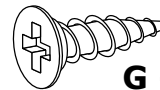

G - 38 St.
3,5x16 mm

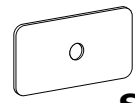

S - 18 St.



E - 65 St.



A - 4 St.
7x50 mm

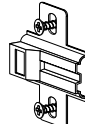

W - 7 St.

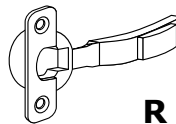

R - 7 St.

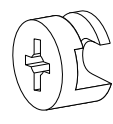

L - 26 St.

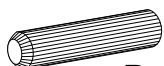

B - 20 St.
8x35 mm

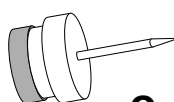

Q - 5 St.

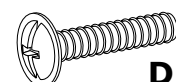

D - 6 St.
4x22 mm



U - 3 St.

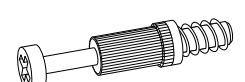

K - 26 St.

I

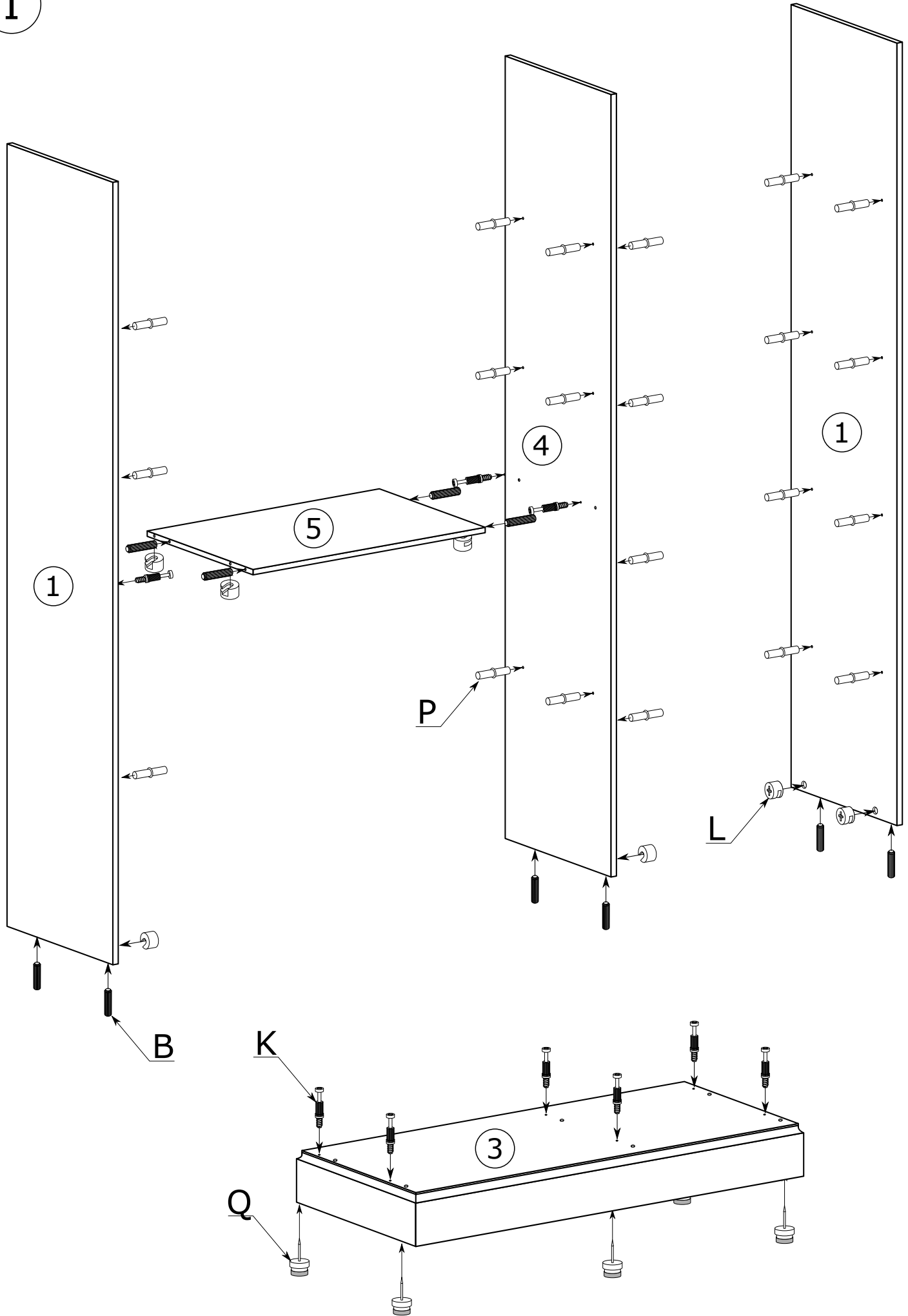

II

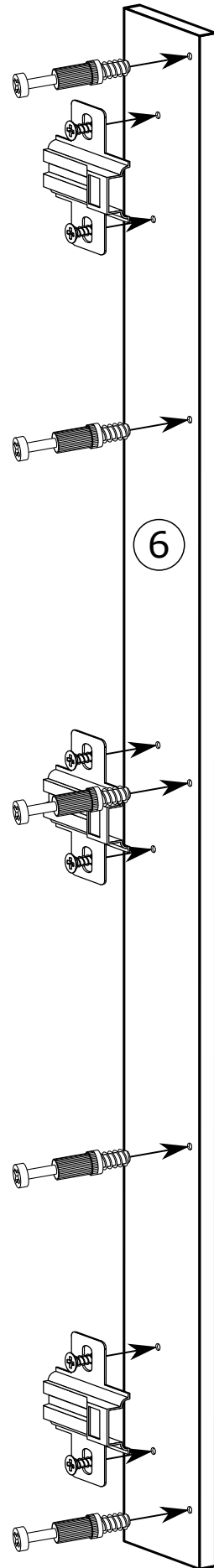
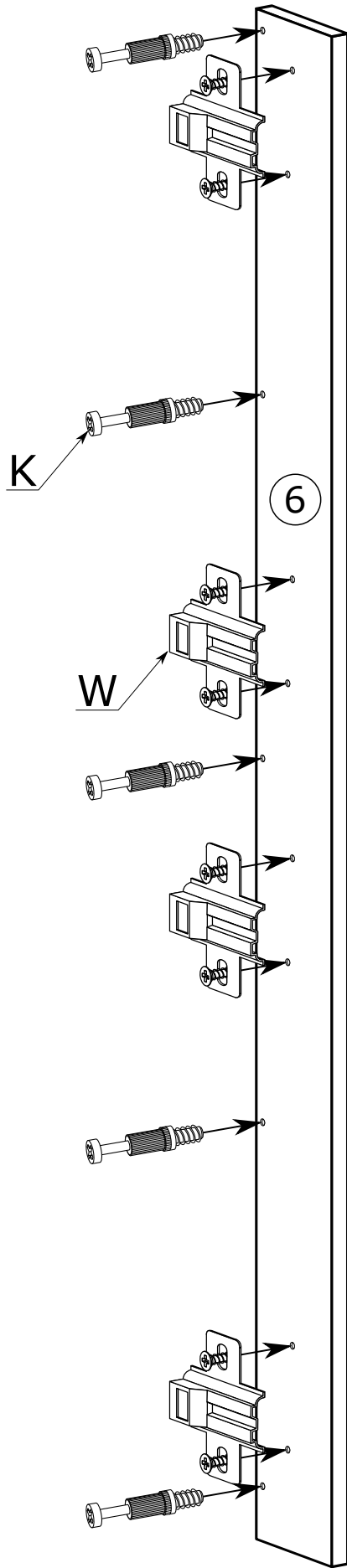

III

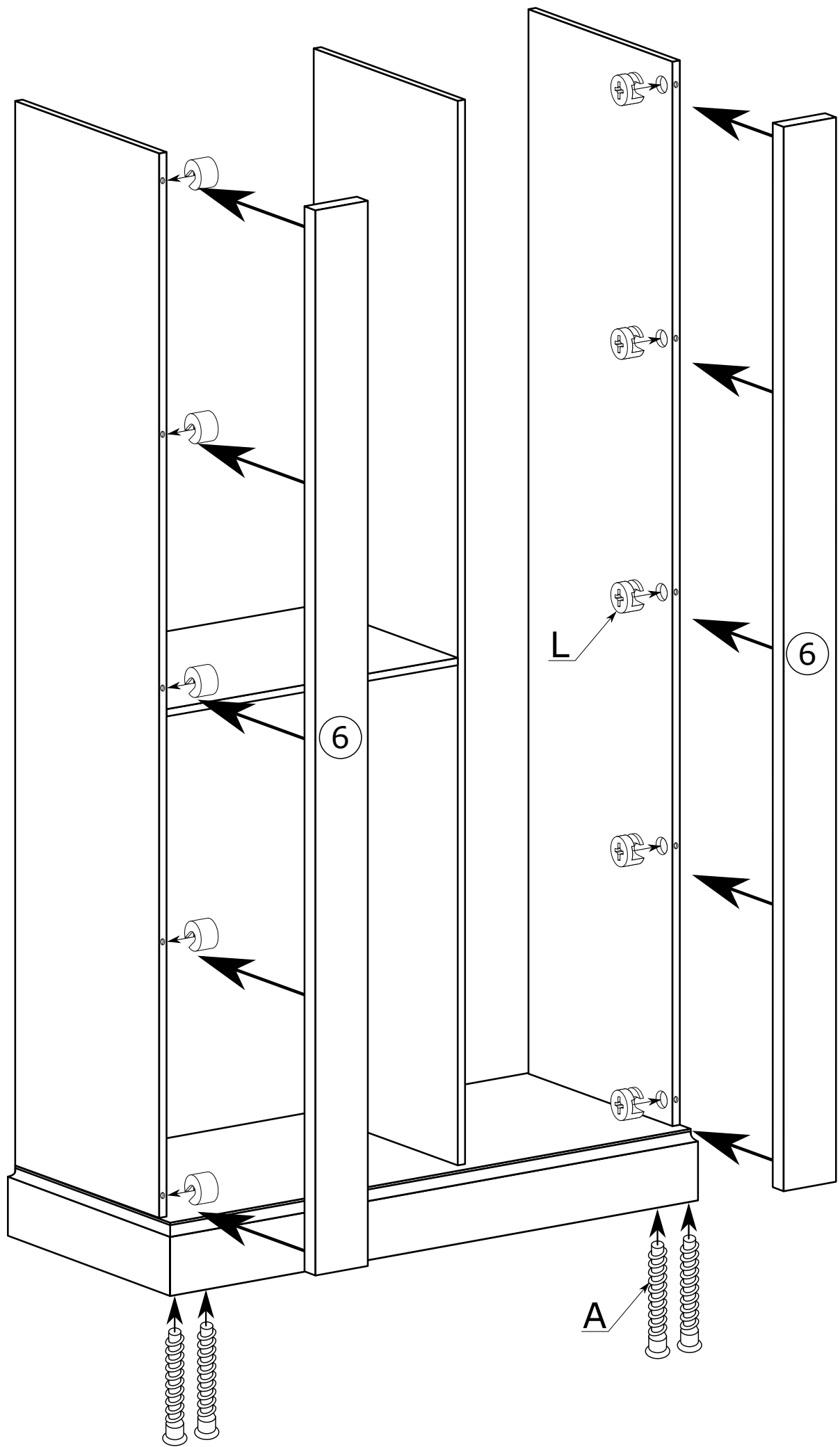

IV

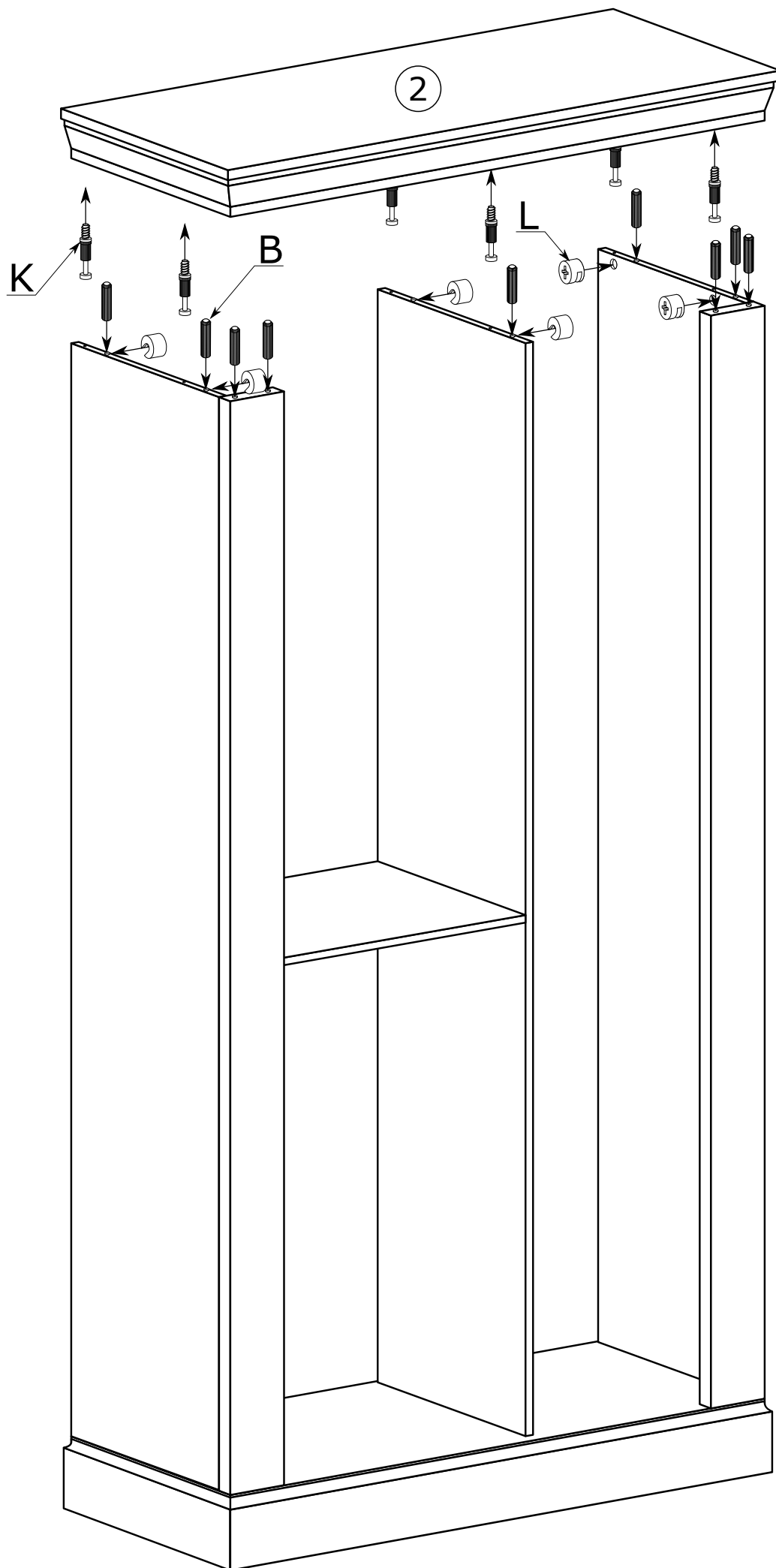

V

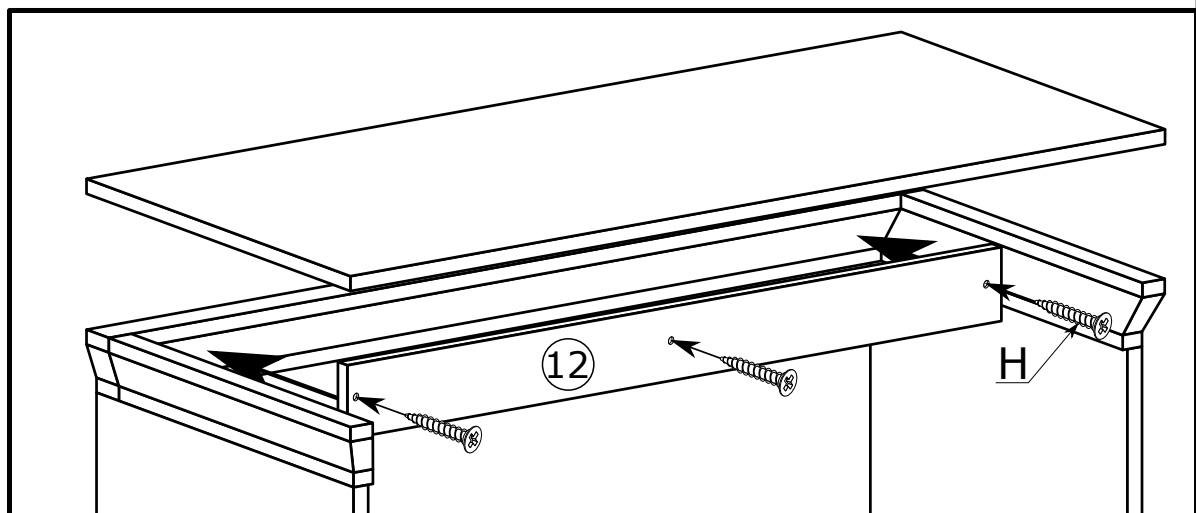
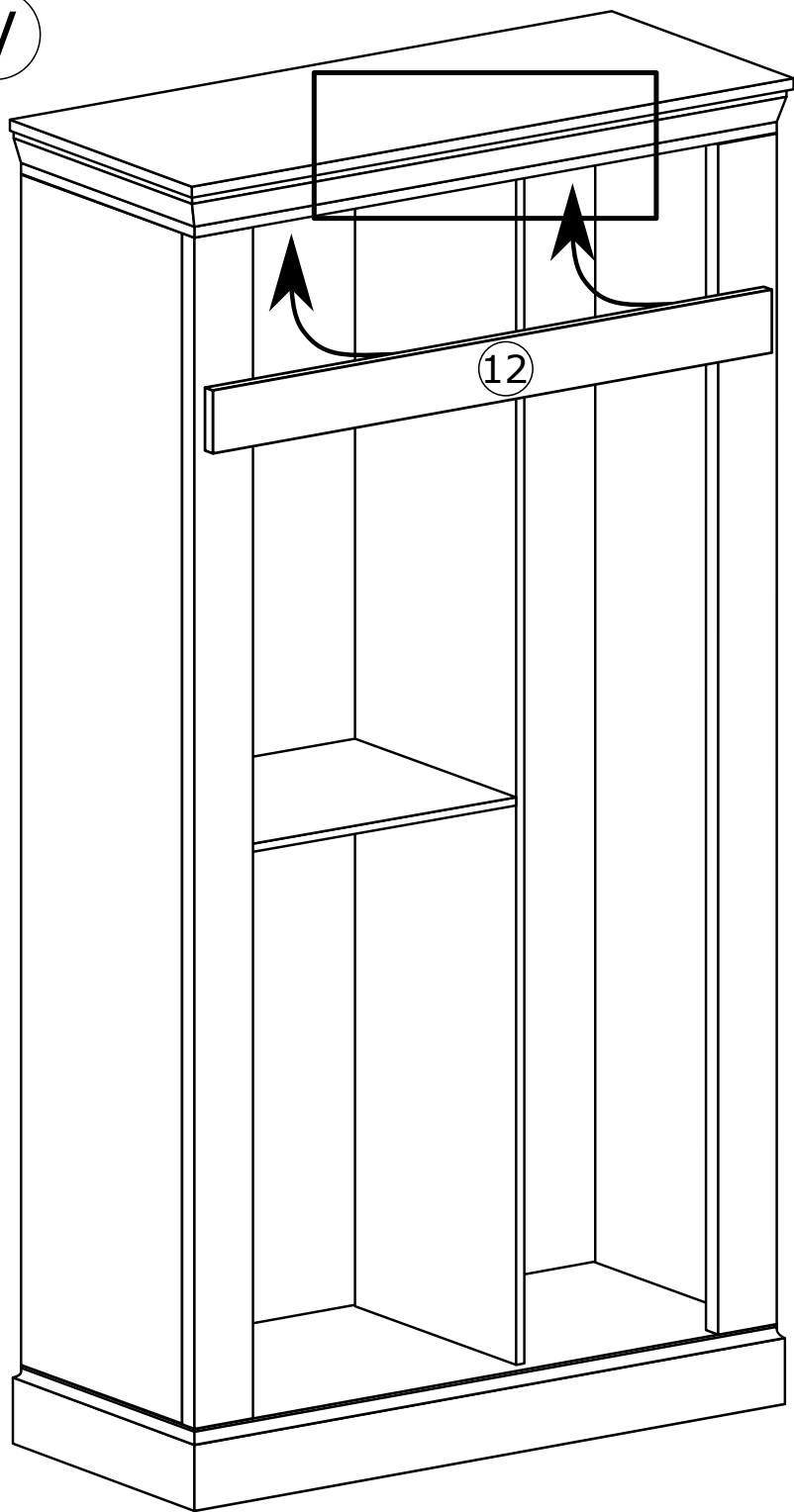

VI

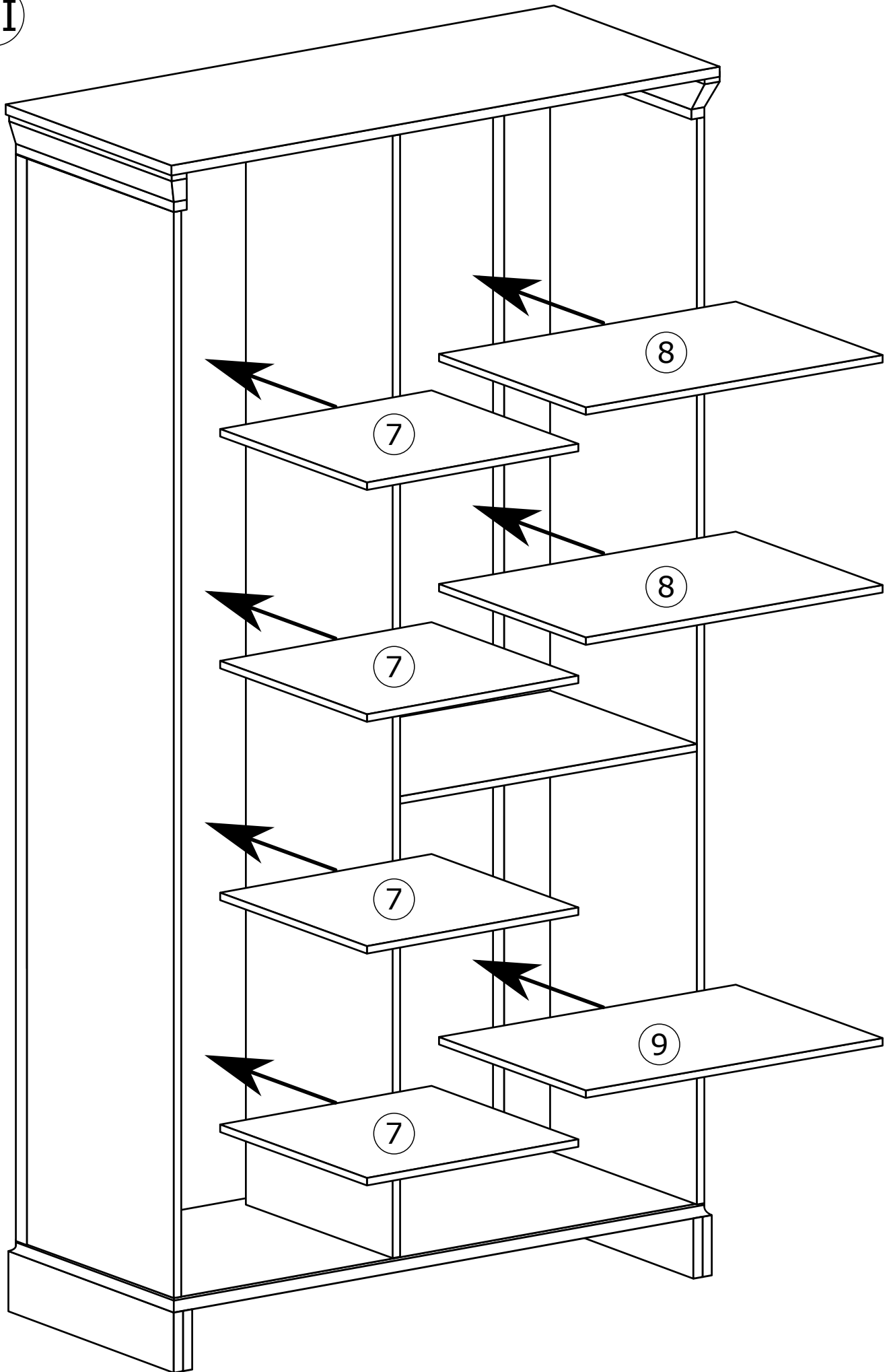

VII

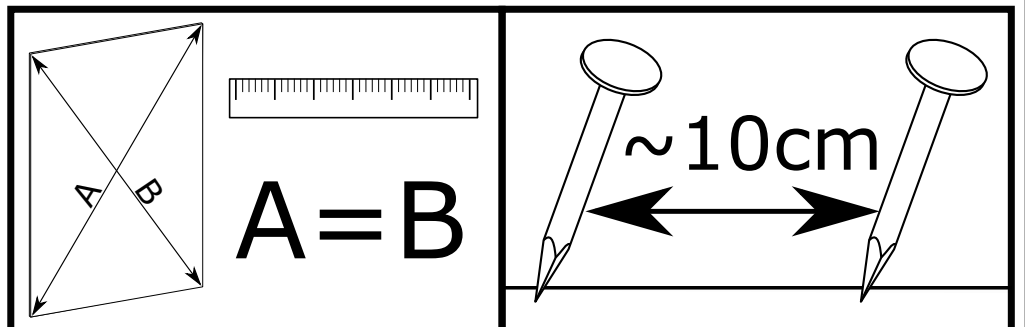
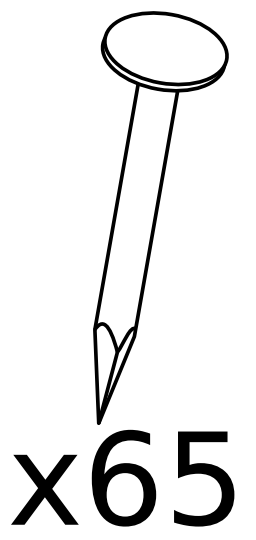
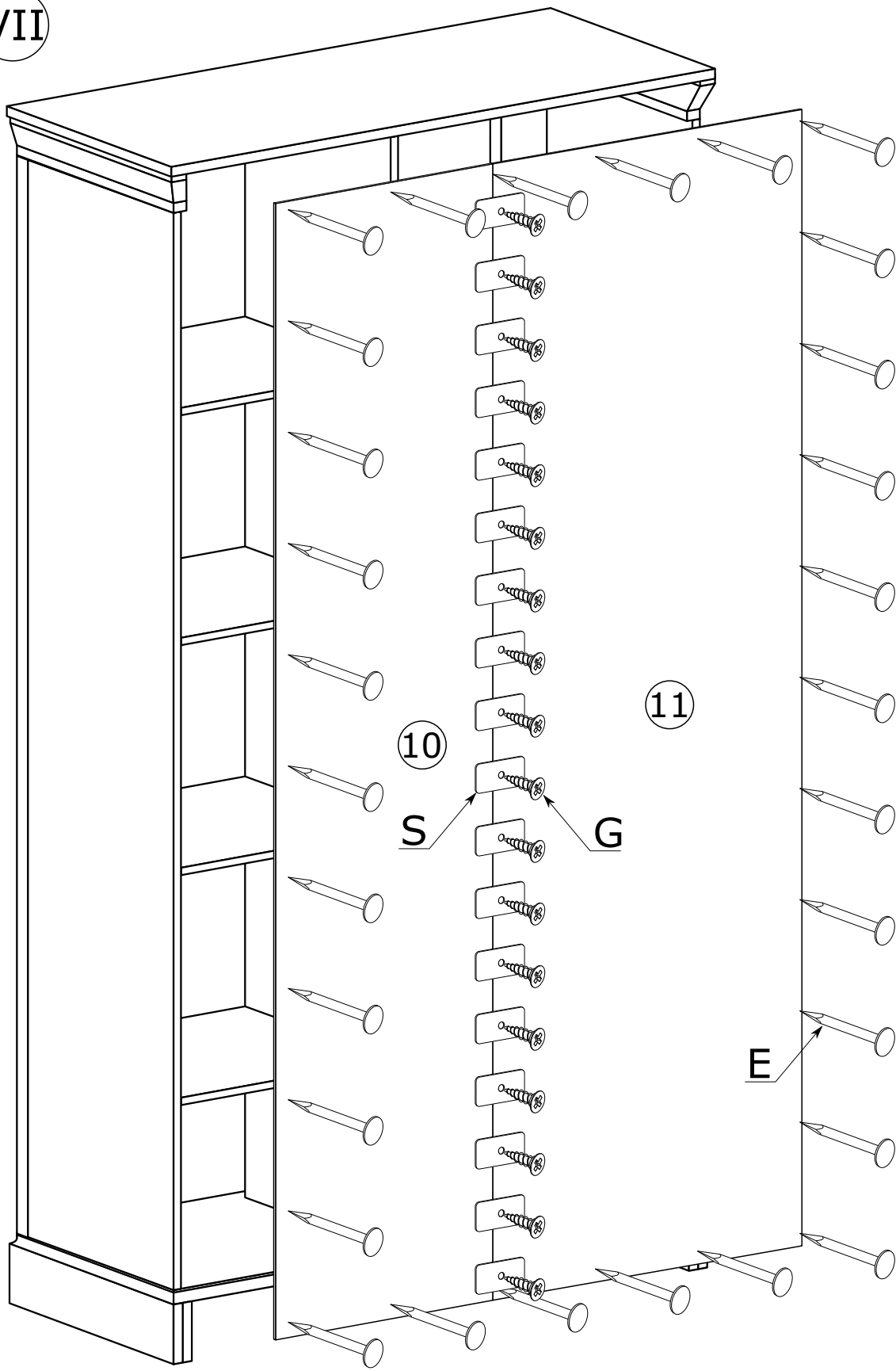

VIII

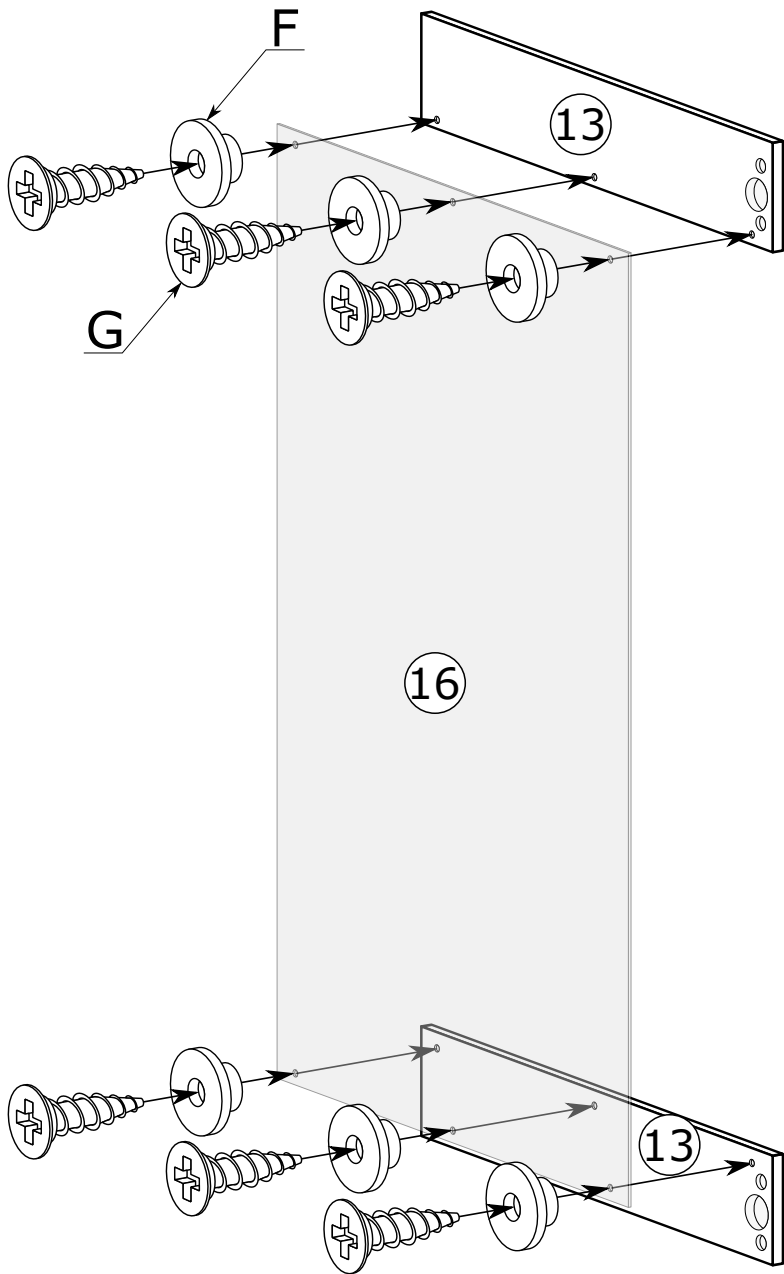

IX

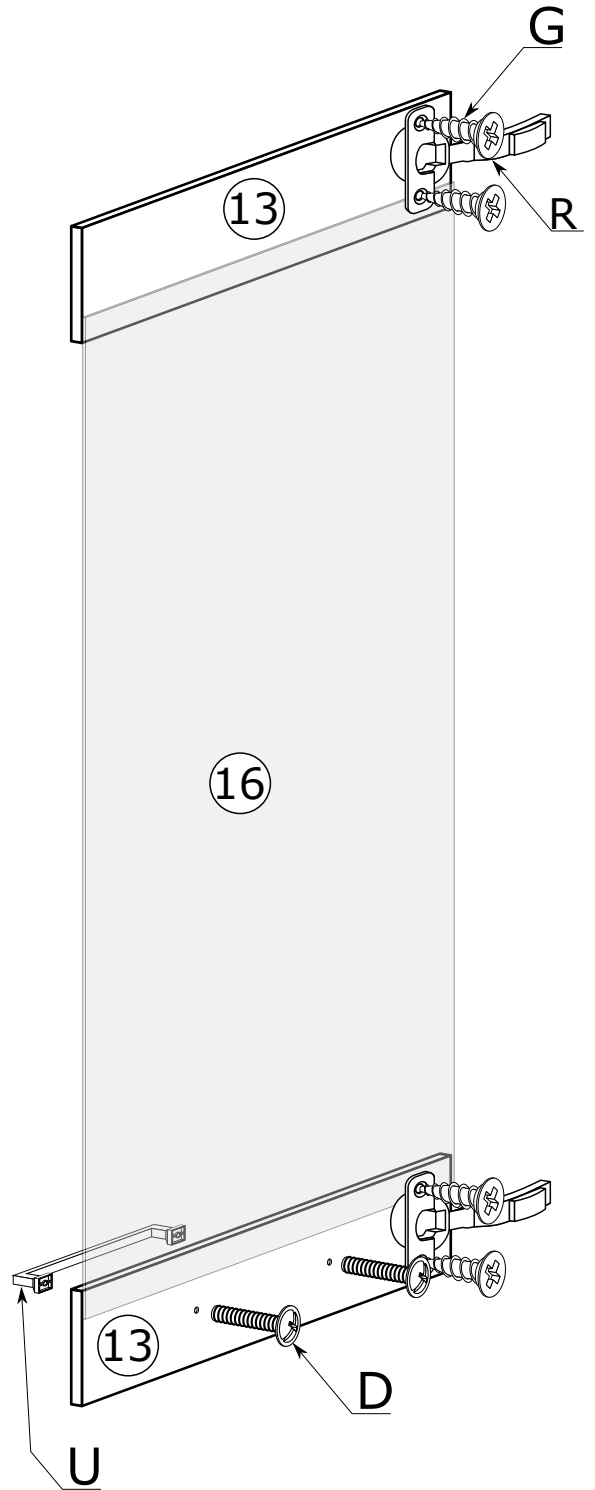

X

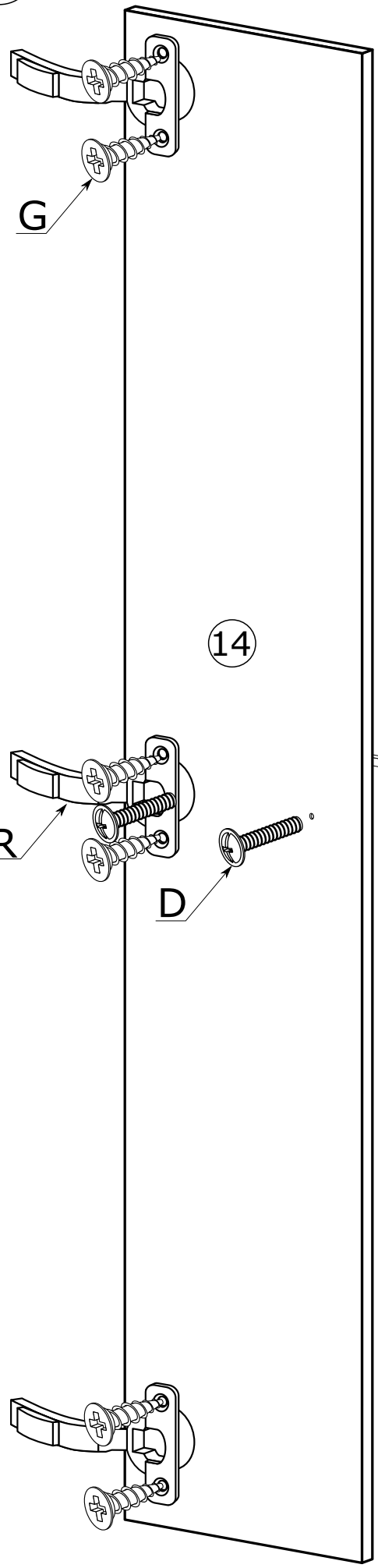

XI

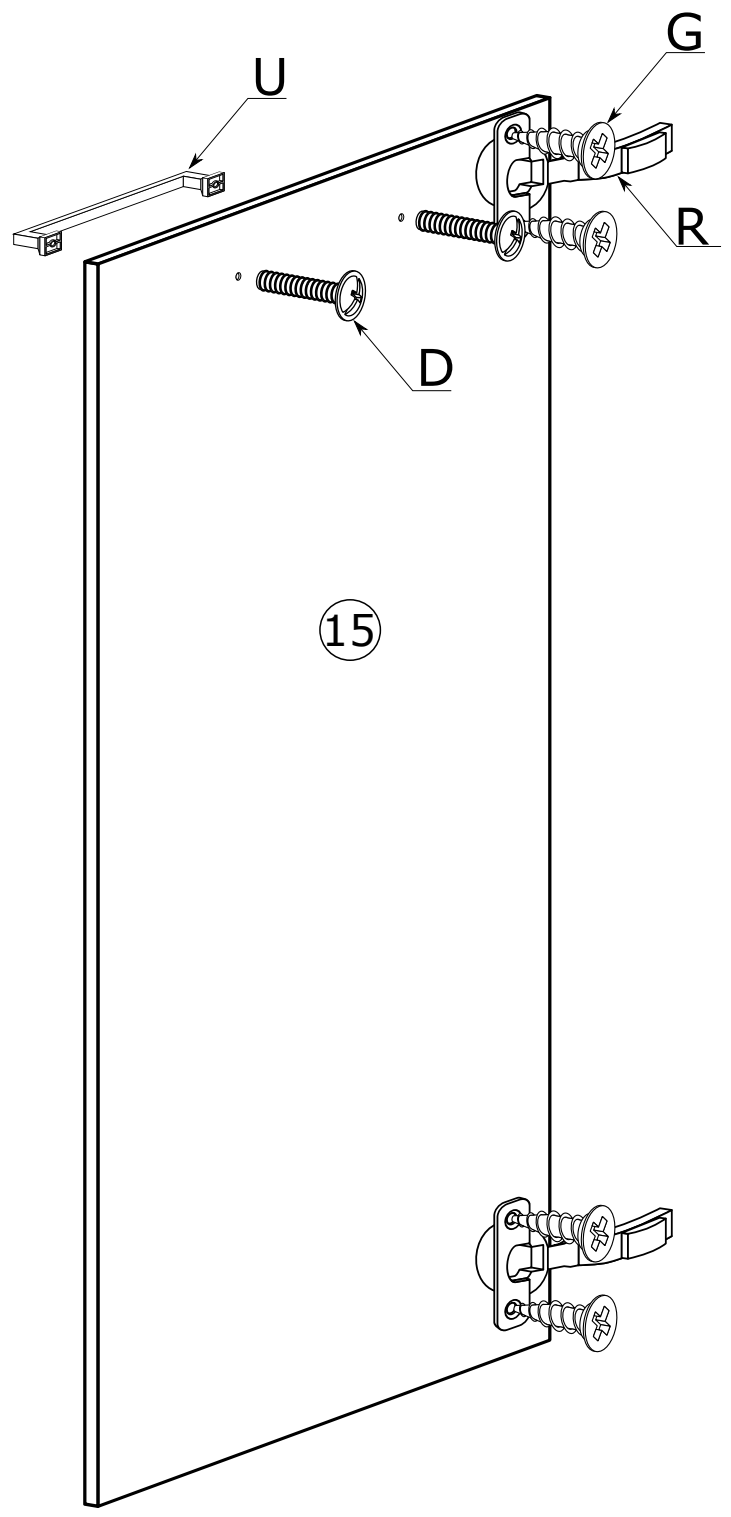

XII

