

ANTICA 7

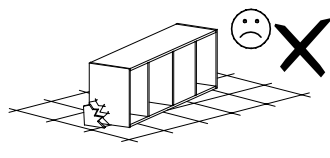

Narzędzia potrzebne do montażu

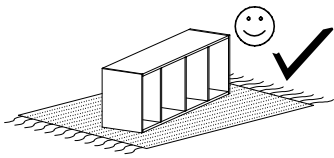
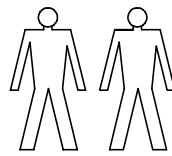
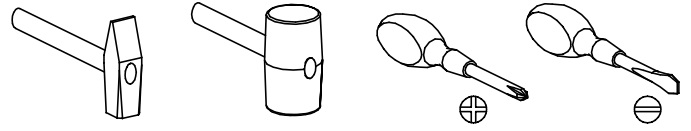

Nr	Nazwa elementu	D[mm]	S[mm]	G[mm]	Ilość
1	Bok P/L	385	328	16	2
2	Błat Górny	420	388	71	1
3	Błat Dolny	393	375	100	1
4	Kapak	410	355	2,5	1
5	Drzwi	355	320	32	1

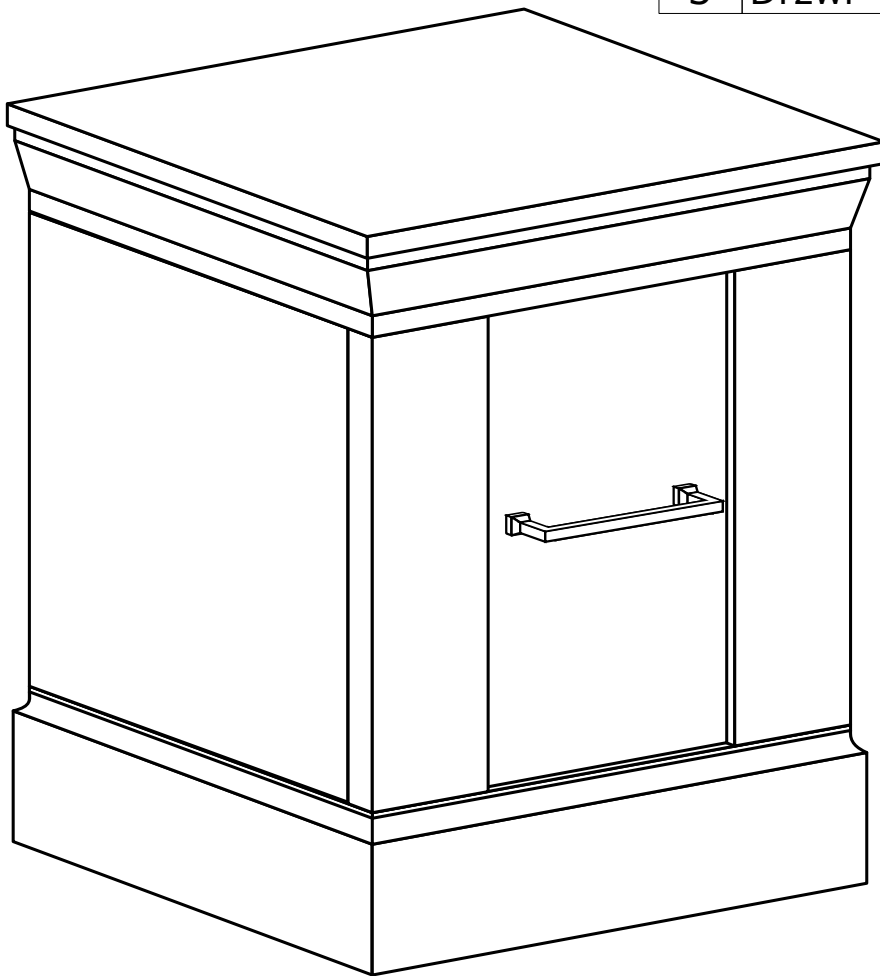

UWAGA !!!

MONTOWANIE USZKODZONYCH
ELEMENTÓW POWODUJE UTRATĘ
GWARANCJI

W przypadku reklamacji proszę podać numer pakowacza znajdujący się na kartonie.



Ł - 1 St.



X1 - 8 St.



E - 20 St.

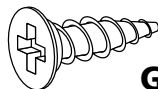

G - 4 St.
3,5x16 mm

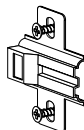

W - 2 St.

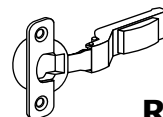

R - 2 St.

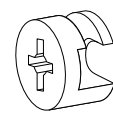

L - 8 St.

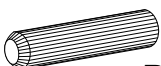

B - 8 St.
8x35 mm

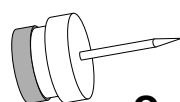

Q - 4 St.

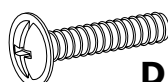

D - 2 St.
4x22 mm

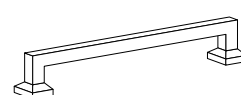

U - 1 St.

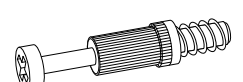

K - 8 St.

I

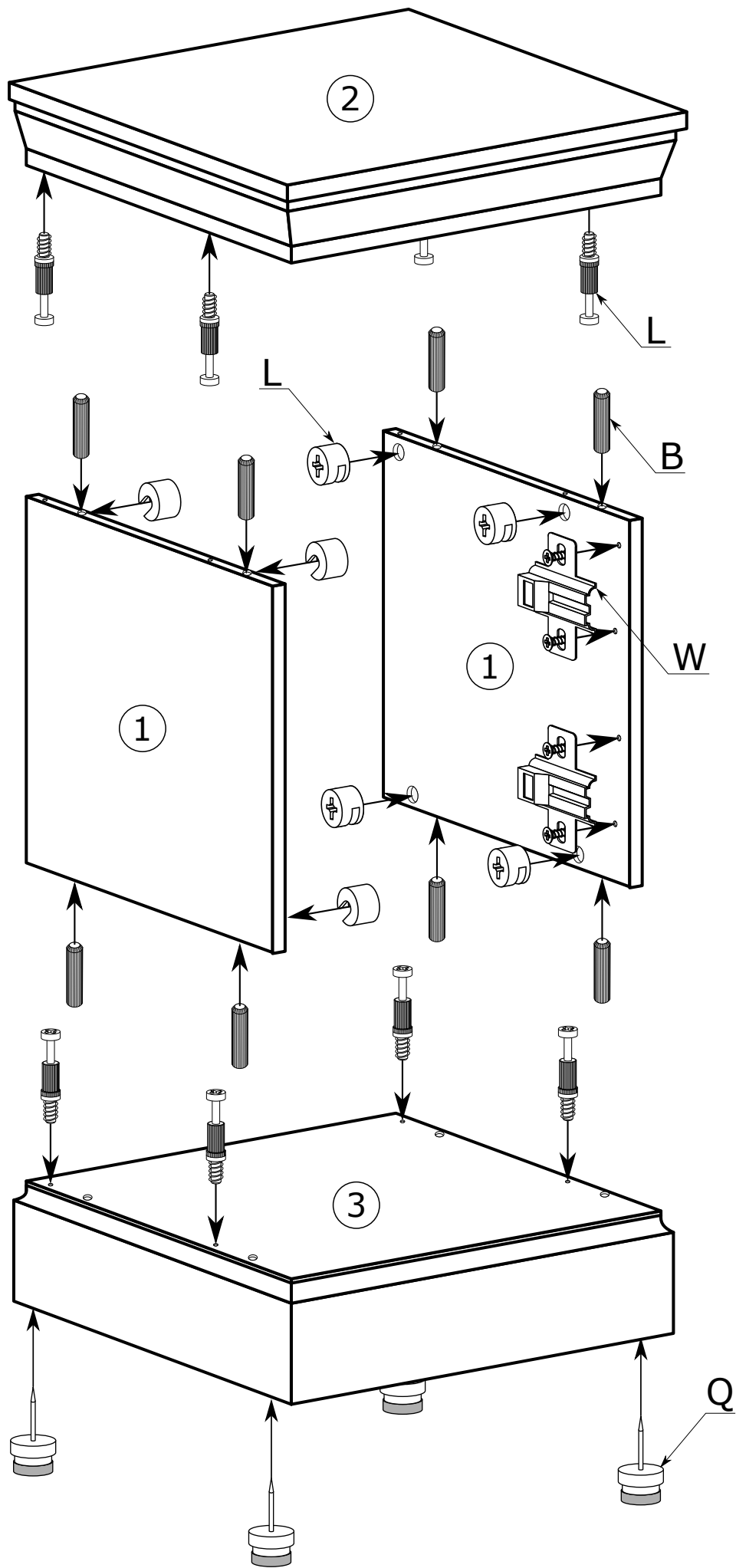

II

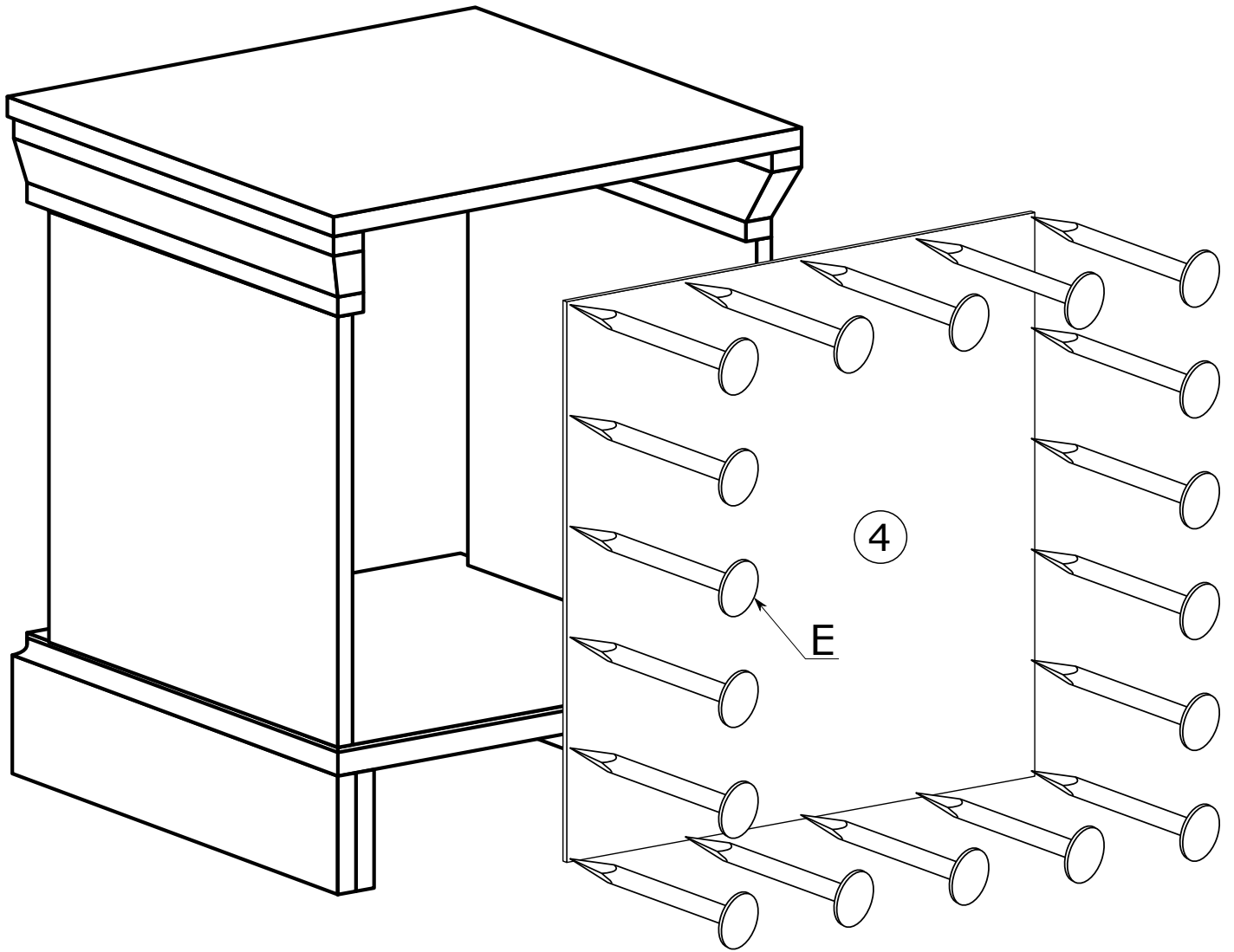

x20

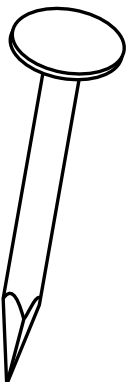
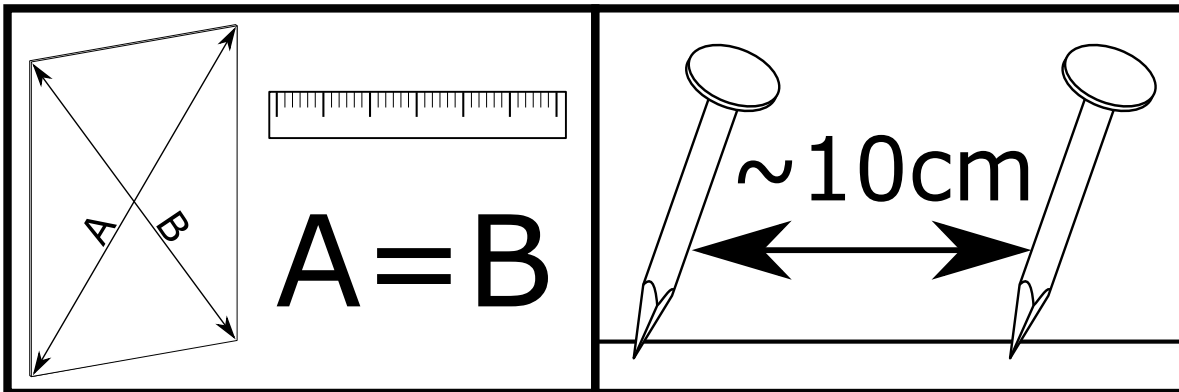

III

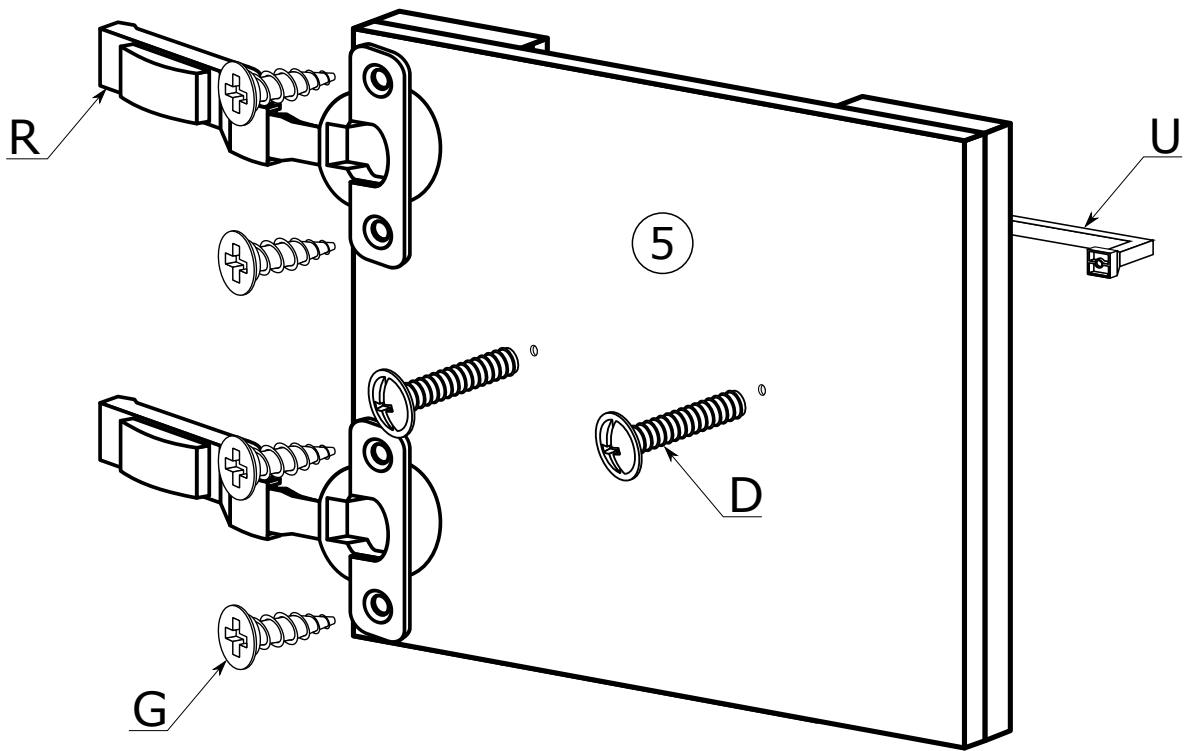

IV

