

# VEGAS 5

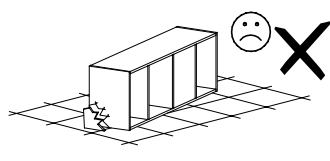

Narzędzia potrzebne do montażu

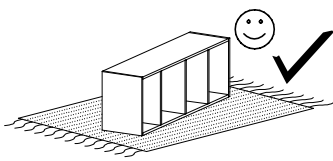
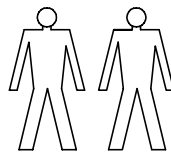
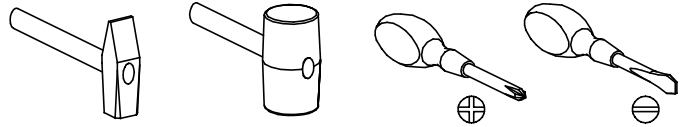

## **UWAGA !!!**

MONTOWANIE USZKODZONYCH  
ELEMENTÓW POWODUJE UTRATĘ  
GWARANCJI

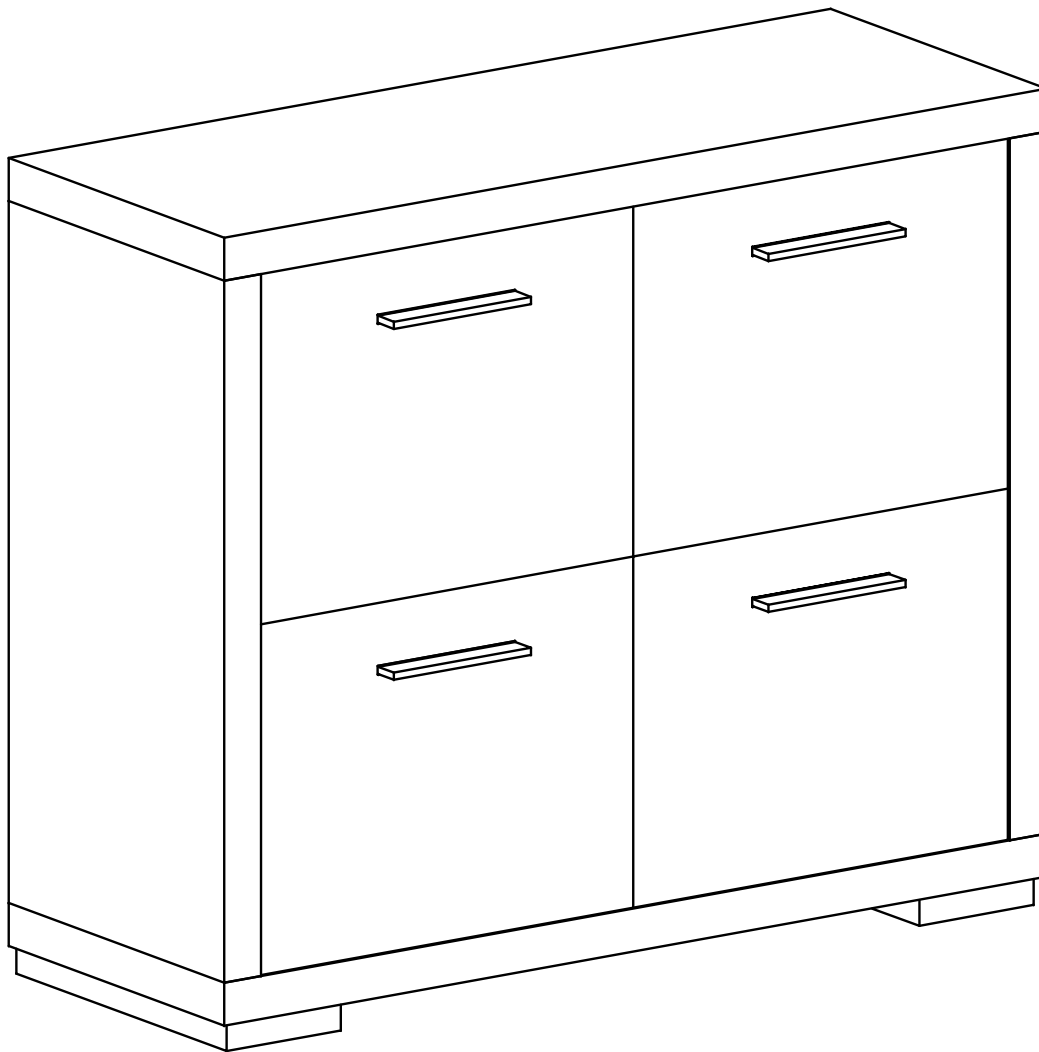

Nr	D[mm]	S[mm]	G[mm]	Ilość
1	1082	407	48	1
2	1082	407	48	1
3	783	405	48	1
4	1047	387	16	1
5	783	405	48	1
6	382	387	16	1
7	382	387	16	1
8	1070	834	2,5	1
9	486	385	16	2
10	486	385	16	2

W przypadku reklamacji proszę podać numer pakowacza znajdujący się na kartonie.

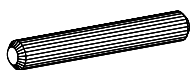

**A - 2 St.**

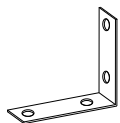

**Y - 2 St.**

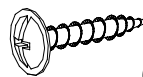

**Q - 4 St.**  
3,5x16 mm

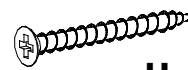

**H - 6 St.**  
4x60 mm



**N - 8 St.**  
4x30 mm



**U - 4 St.**

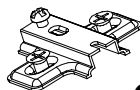

**C - 8 St.**

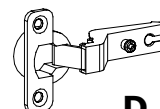

**D - 8 St.**



**G - 16 St.**  
3,5x16 mm



**E - 50 St.**



**B - 16 St.**

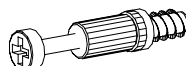

**K - 16 St.**

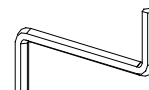

**Z - 1 St.**



**L - 16 St.**

I

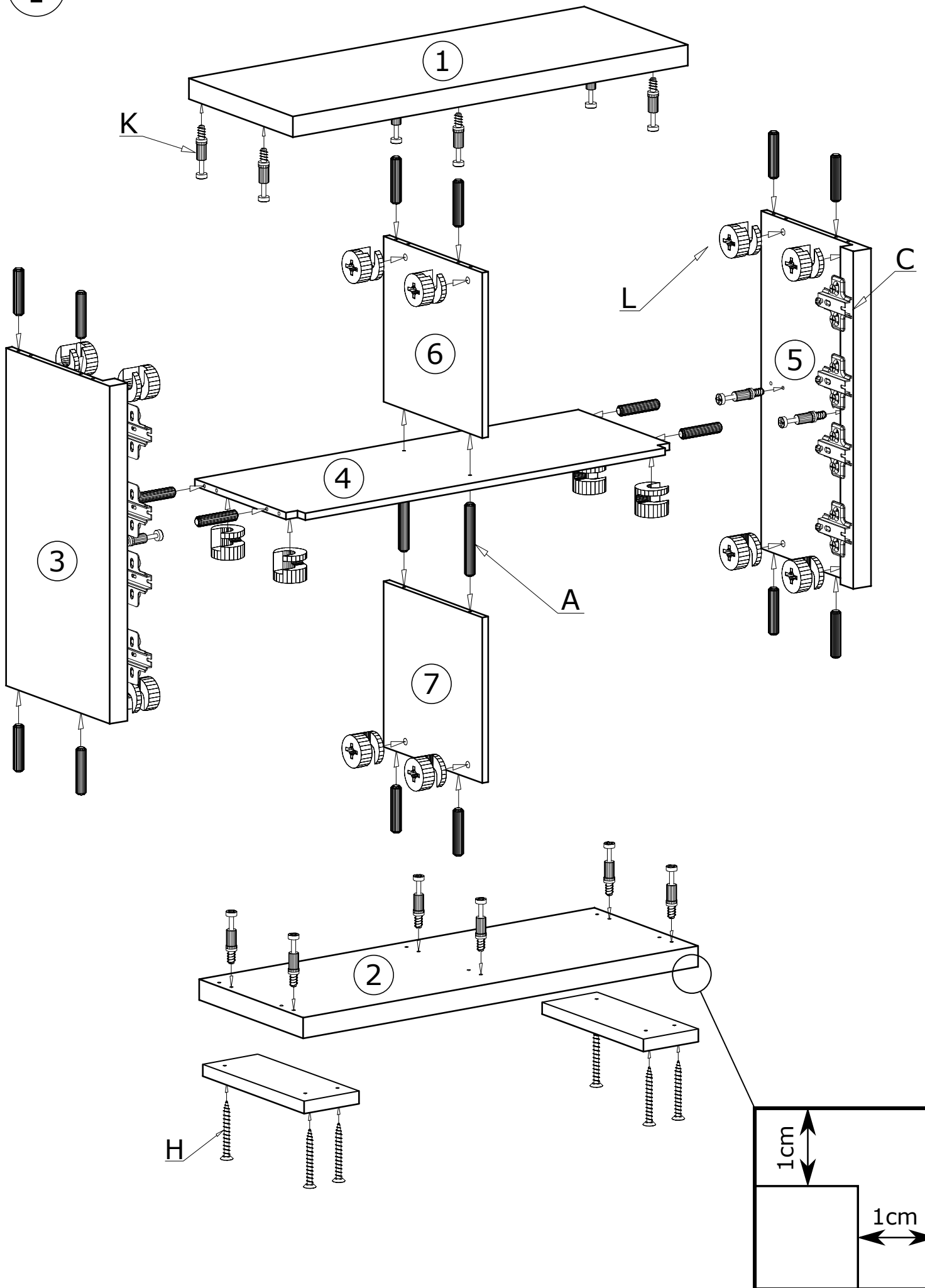

II

50X 

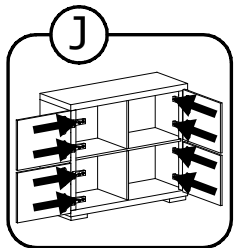
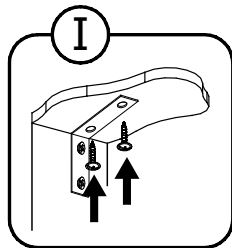
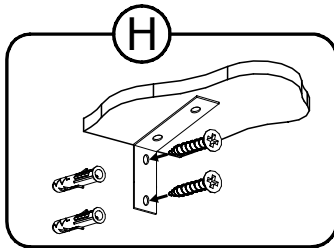
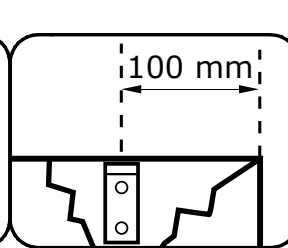
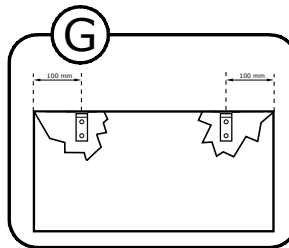
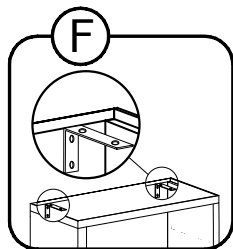
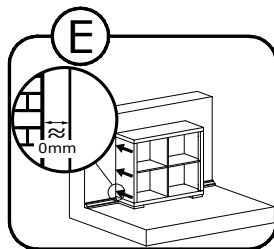
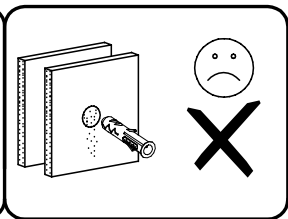
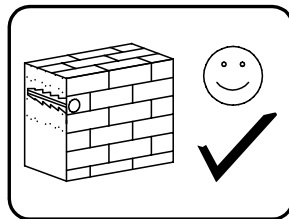
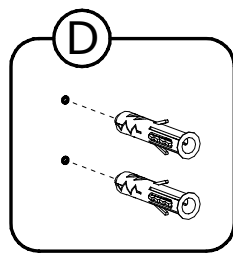
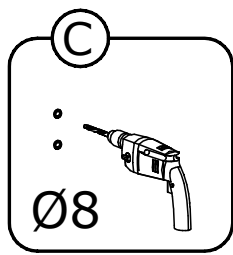
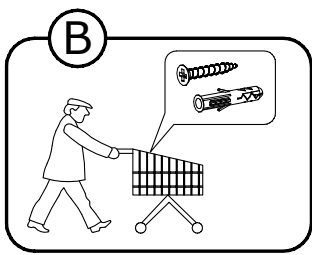
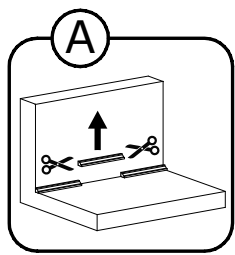
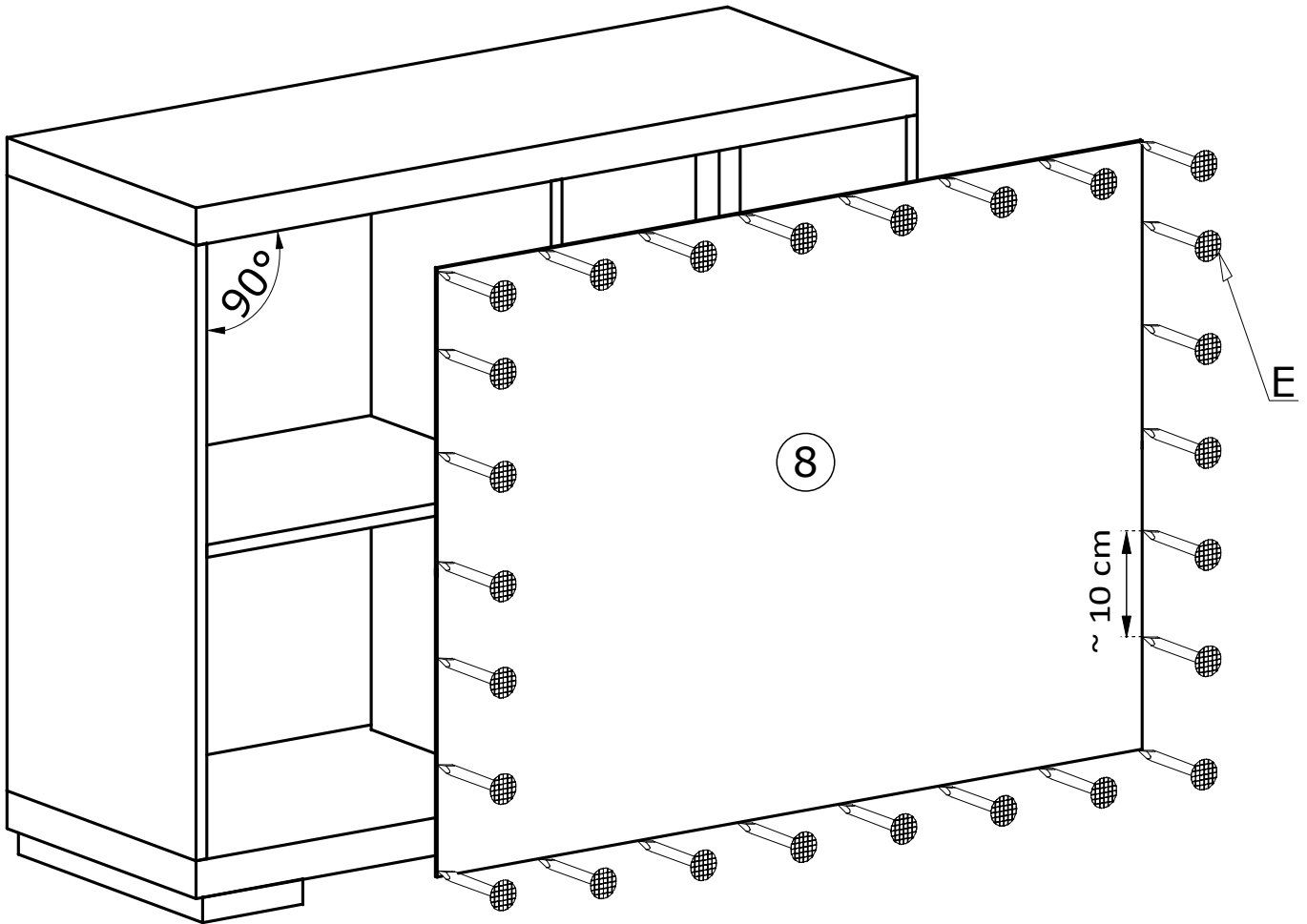

III

