

VEGAS 38

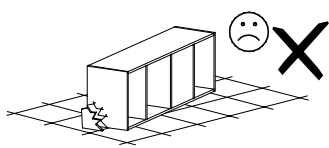

Narzędzia potrzebne do montażu

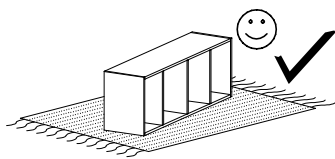
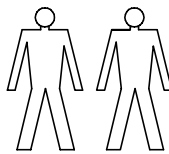
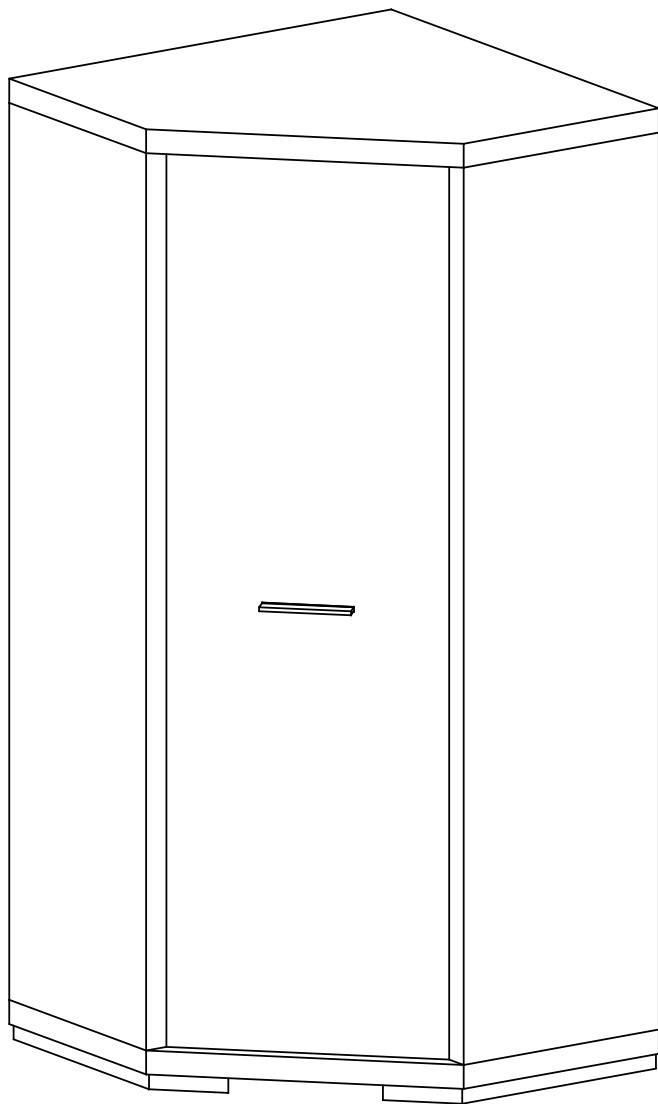

UWAGA !!!

MONTOWANIE USZKODZONYCH
ELEMENTÓW POWODUJE UTRATĘ
GWARANCJI

Nr	D[mm]	S[mm]	G[mm]	Ilość
1	900	900	48	1
2	900	900	48	1
3	1793	460	48	1
4	1793	460	48	1
5	1790	350	16	1
6	1790	350	16	1
7	355	350	16	4
8	867	80	16	1
9	1780	557	16	1
10	1820	890	2,5	1
11	1820	564	2,5	1

W przypadku reklamacji proszę podać numer pakowacza znajdujący się na kartonie.

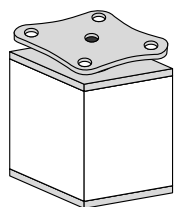

A - 1 St.

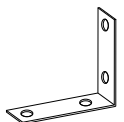

Y - 2 St.

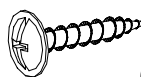

Q - 4 St.
4x25 mm

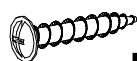

N - 2 St.
4x30 mm



U - 1 St.



G - 50 St.
3,5x16 mm

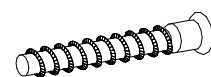

W - 4 St.

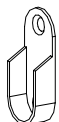

T - 2 St.



E - 100 St.

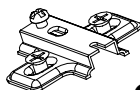

C - 4 St.

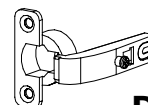

D - 4 St.



M - 1 St.



P - 16 St.

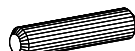

B - 18 St.

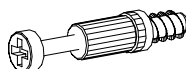

K - 16 St.

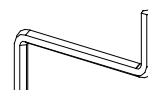

Z - 1 St.

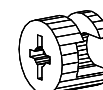

L - 16 St.

I

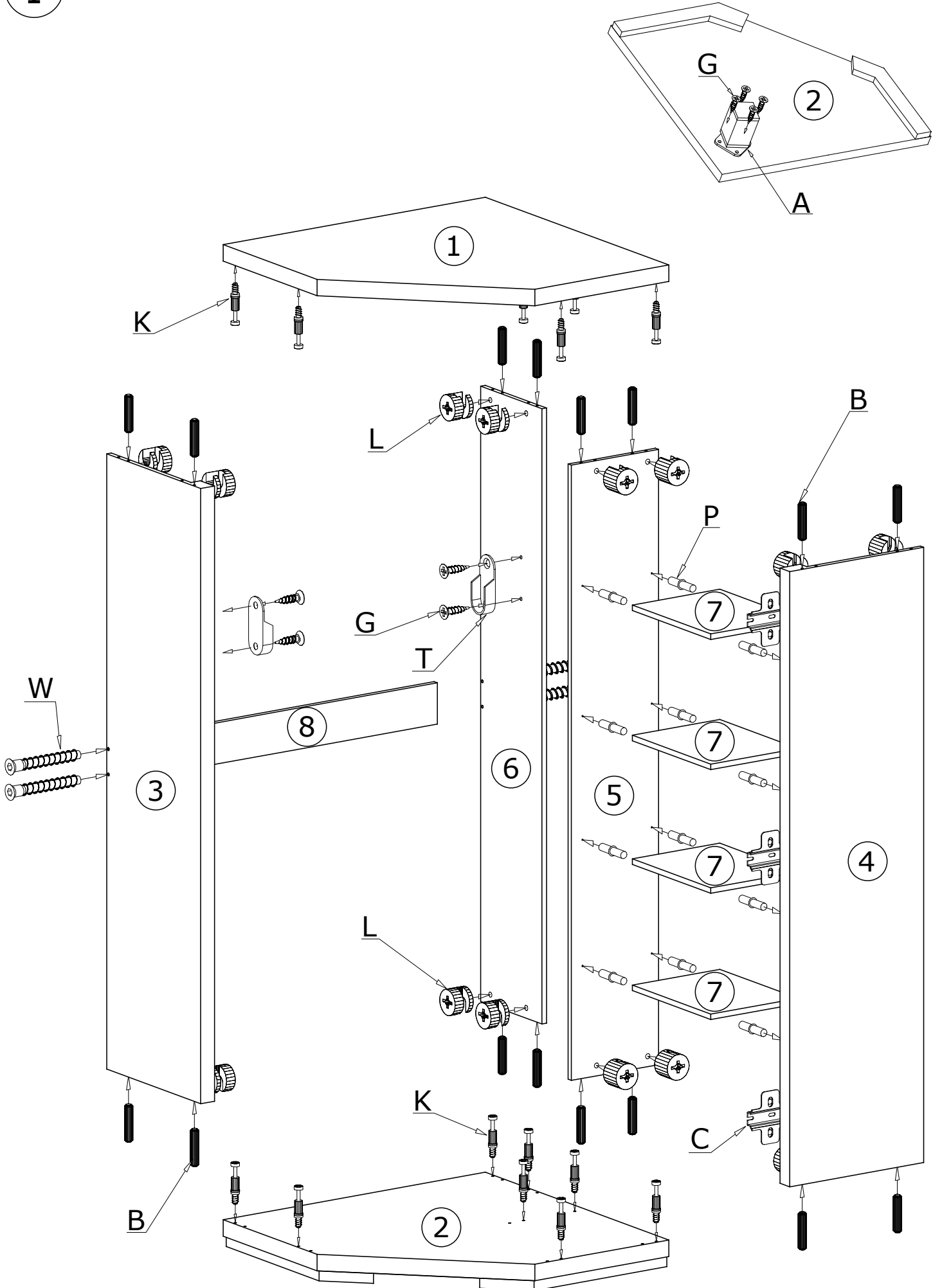

II

100X 

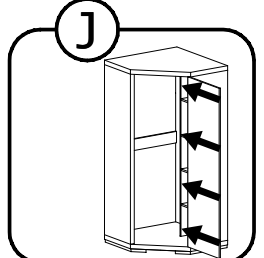
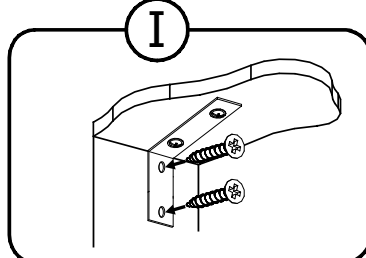
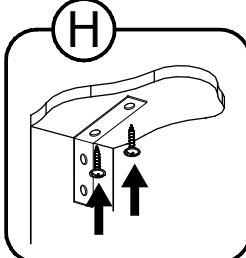
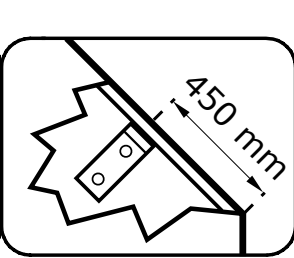
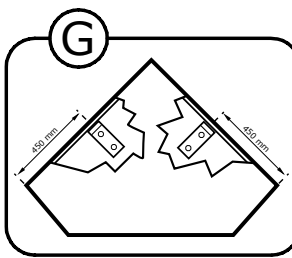
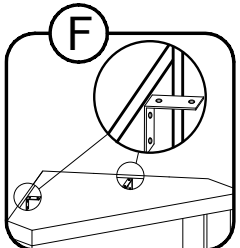
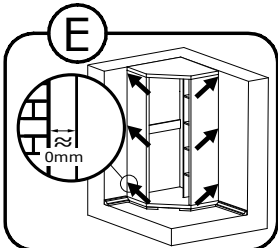
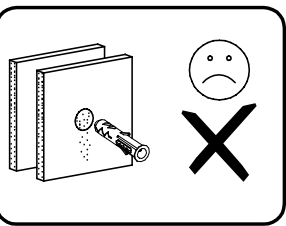
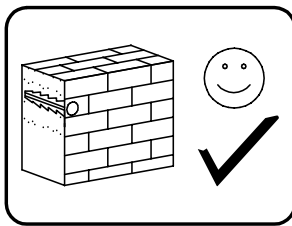
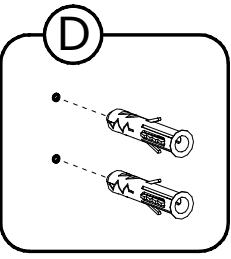
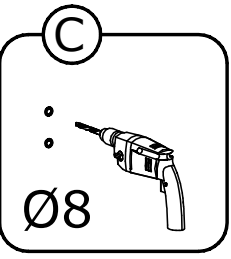
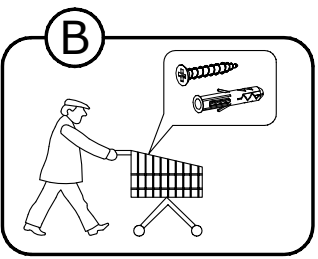
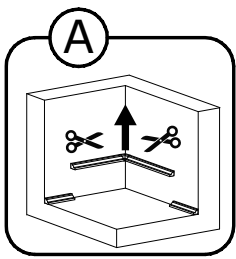
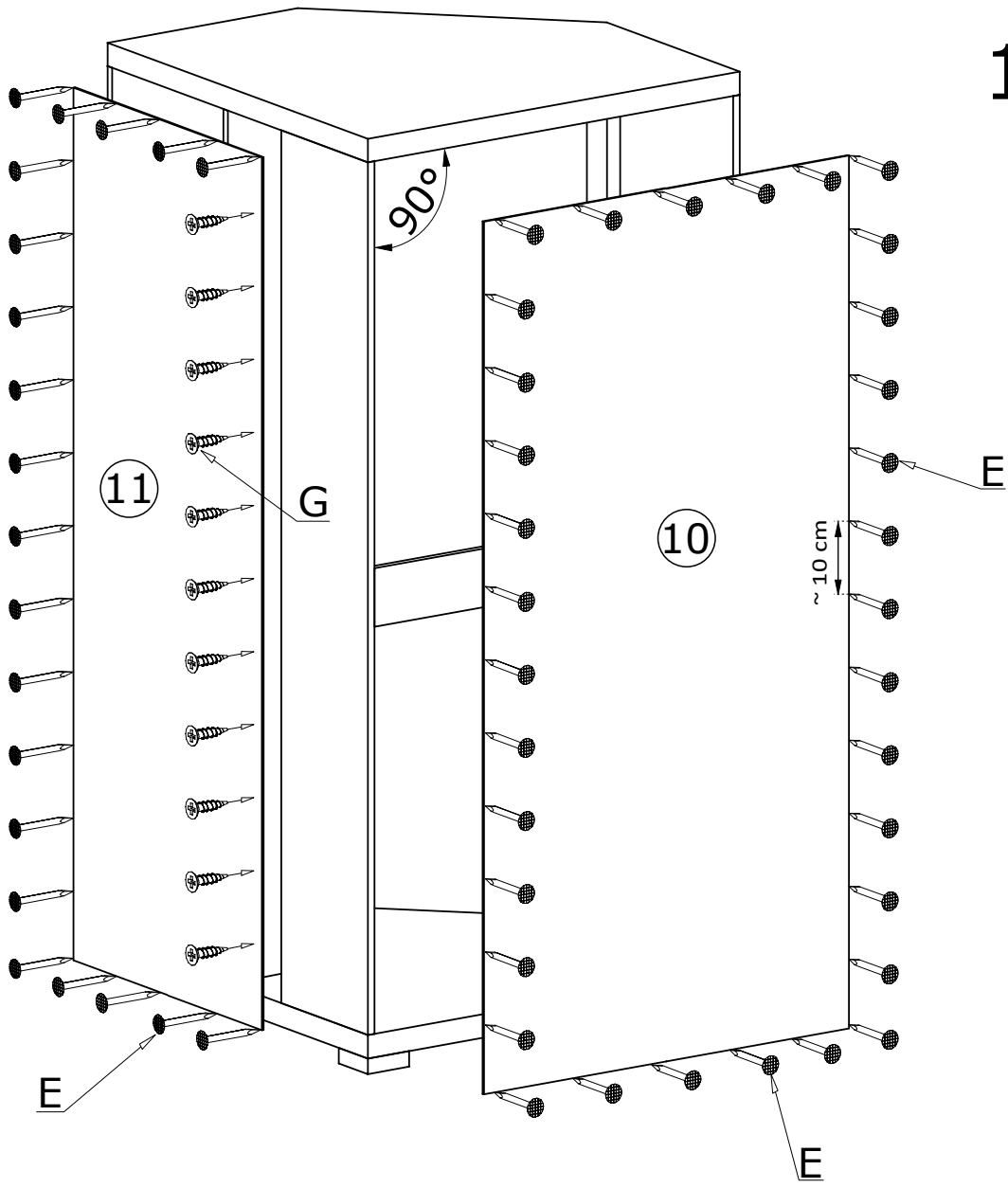

III

