

# VEGAS 37

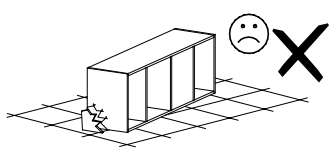

Narzędzia potrzebne do montażu

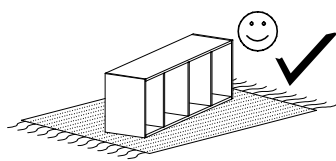
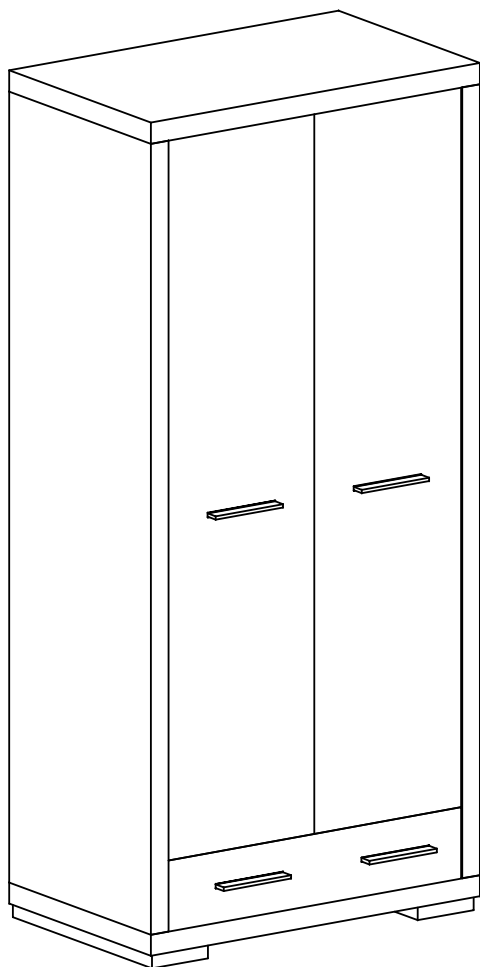
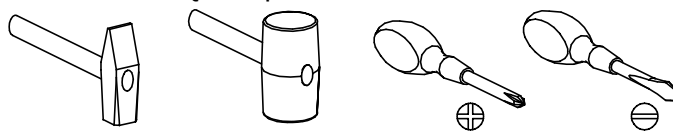

## UWAGA !!!

MONTOWANIE USZKODZONYCH  
ELEMENTÓW POWODUJE UTRATĘ  
GWARANCJI

Nr	D[mm]	S[mm]	G[mm]	Ilość
1	883	542	48	1
2	883	542	48	1
3	848	522	16	1
4	1793	540	48	1
5	1793	540	48	1
6	1820	890	2,5	1
7	780	190	16	1
8	500	165	16	1
9	726	165	16	1
10	500	165	16	1
11	757	505	2,5	1
12	388	1590	16	1
13	388	1590	16	1

W przypadku reklamacji proszę podać numer pakowacza znajdujący się na kartonie.

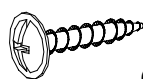

**Q - 4 St.**  
3,5x16 mm

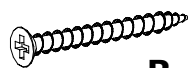

**R - 6 St.**  
4x60 mm



**X1 - 6 St.**



**X2 - 2 St.**

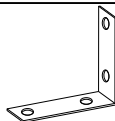

**Y - 2 St.**



**O - 1 St.**

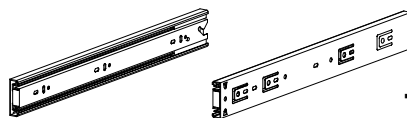

**T - 1 Kpl.**



**F - 4 St.**

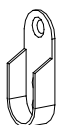

**A - 2 St.**



**N - 8 St.**  
4x30 mm



**U - 4 St.**

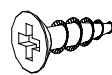

**G - 16 St.**  
3,5x16 mm



**L - 18 St.**



**M - 20 St.**  
3x30 mm

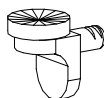

**P - 2 St.**

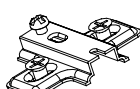

**C - 6 St.**

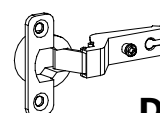

**D - 6 St.**



**S - 1 St.**



**E - 60 St.**



**B - 20 St.**

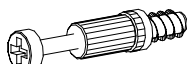

**K - 18 St.**

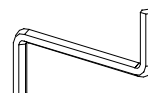

**Z - 1 St.**



**J - 8 St.**  
5x13 mm

I

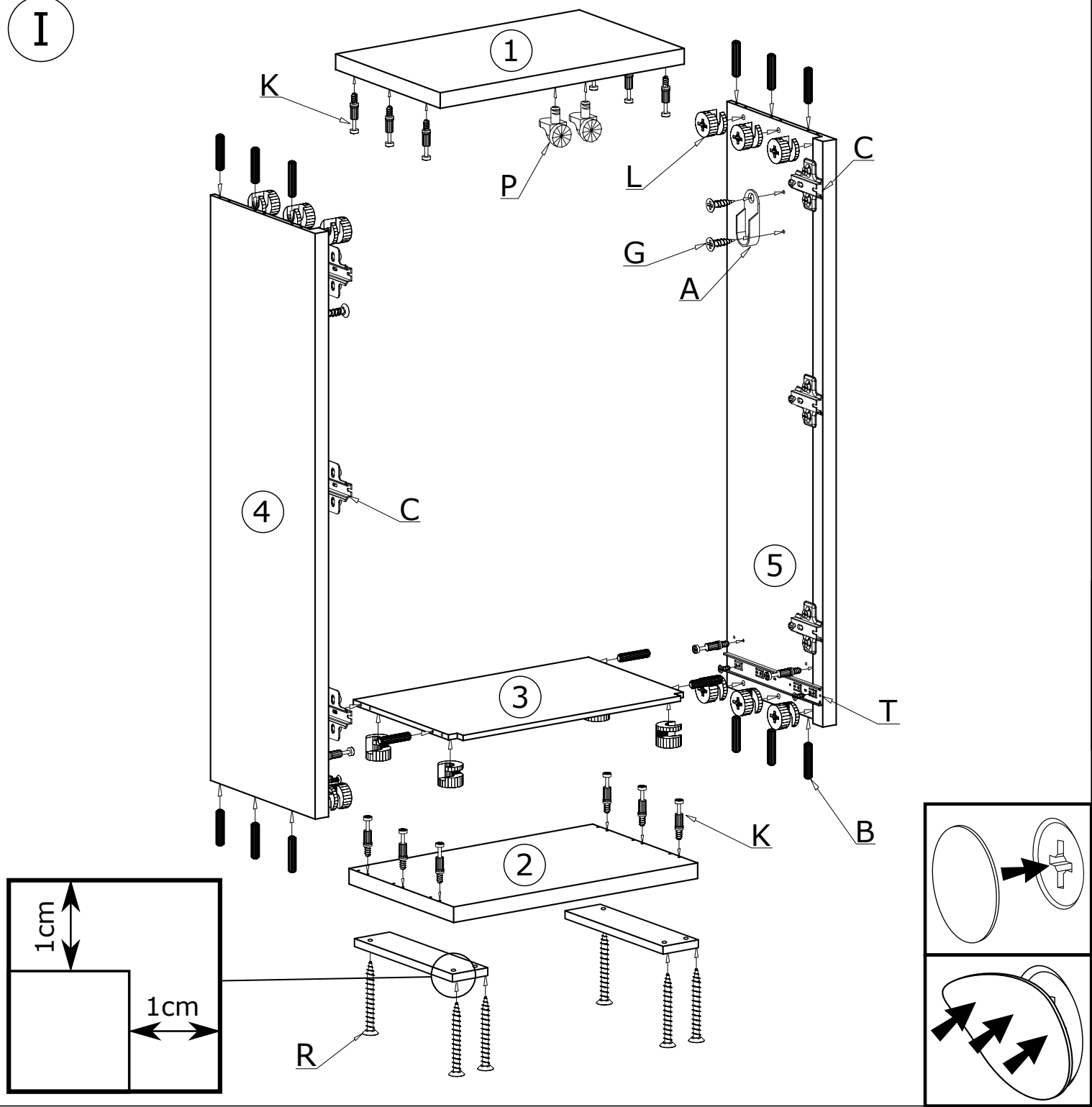

II

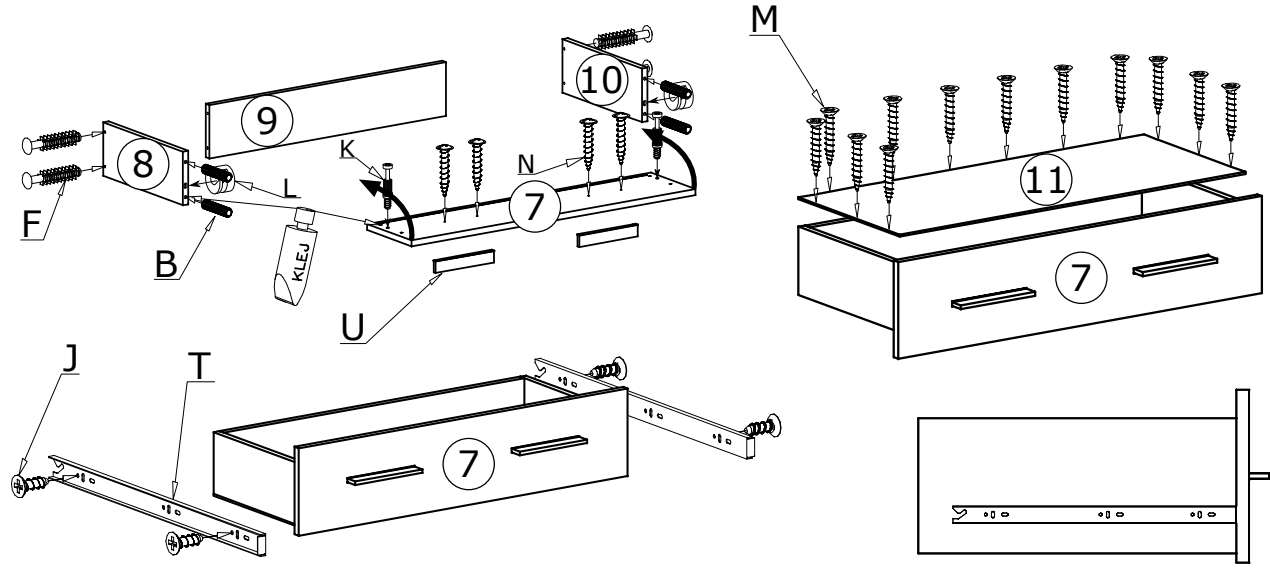

III

60X 

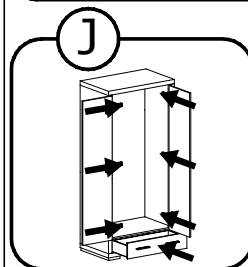
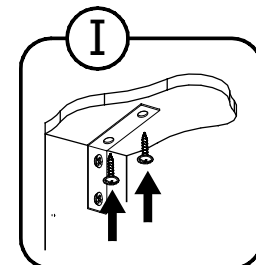
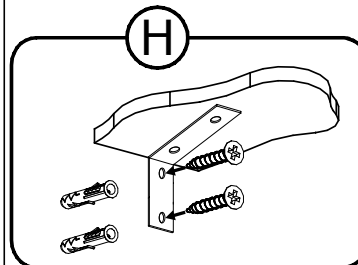
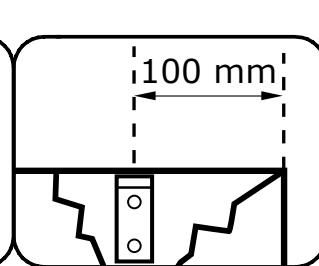
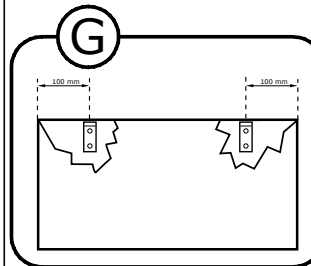
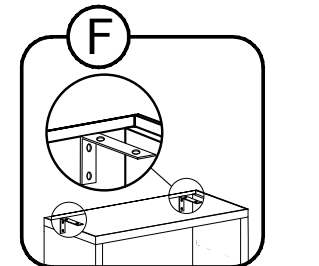
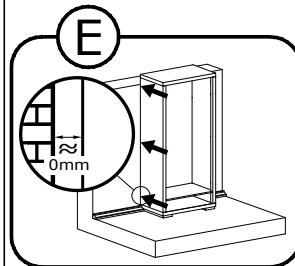
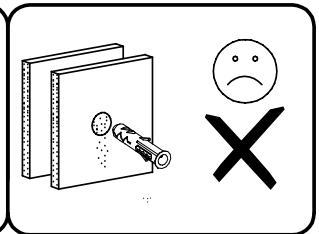
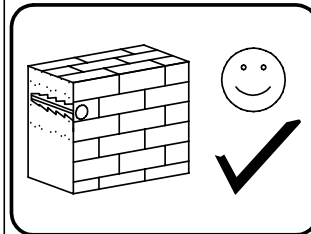
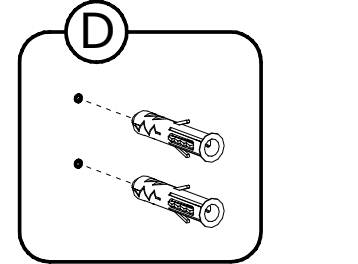
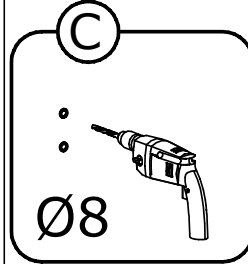
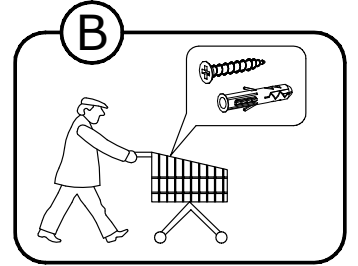
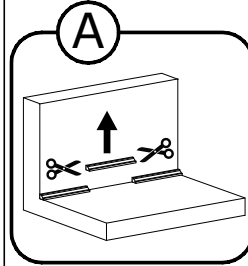
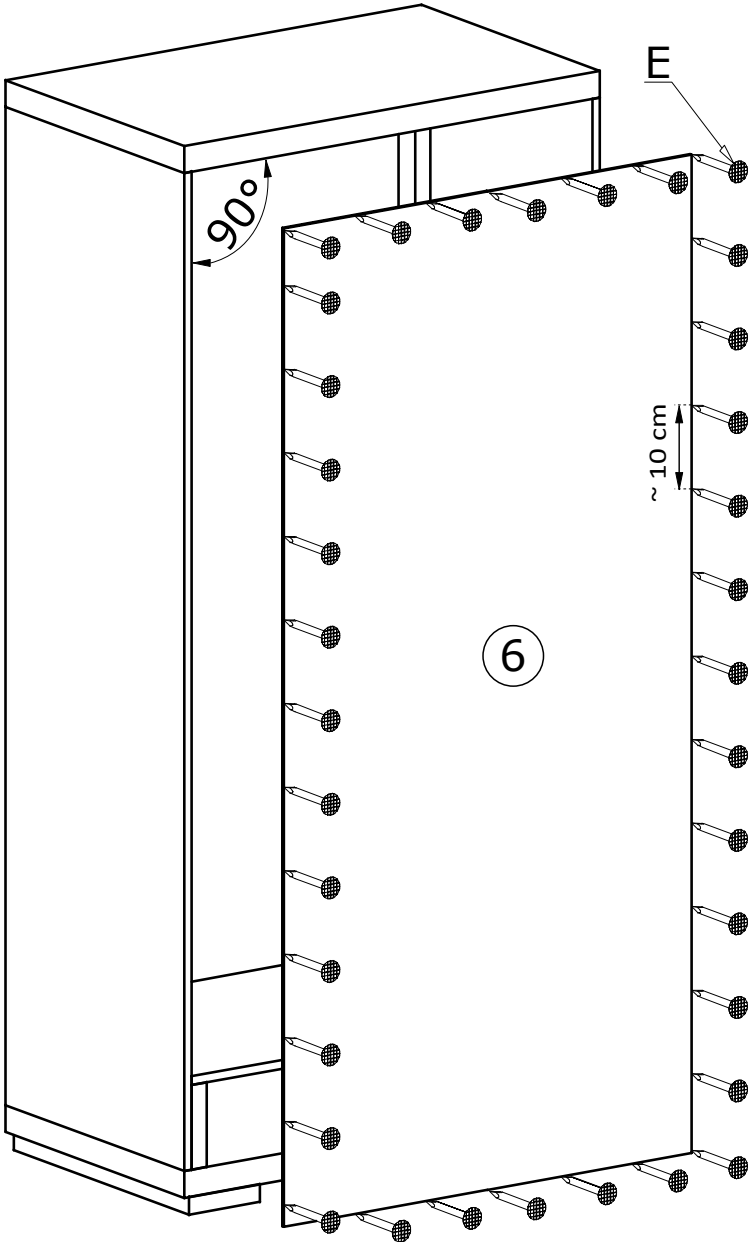

IV

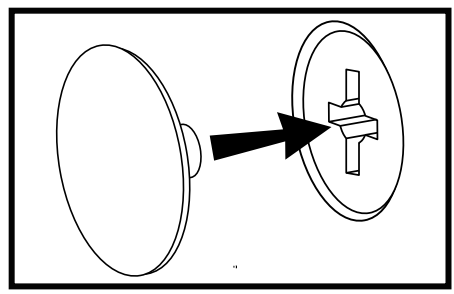
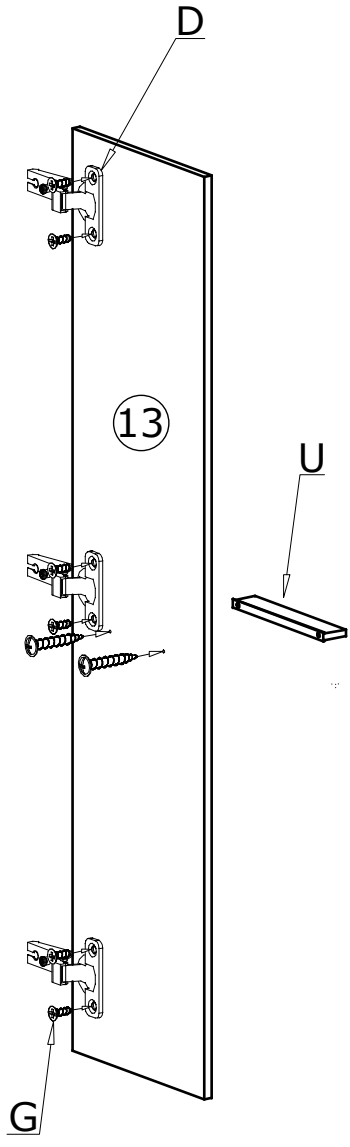
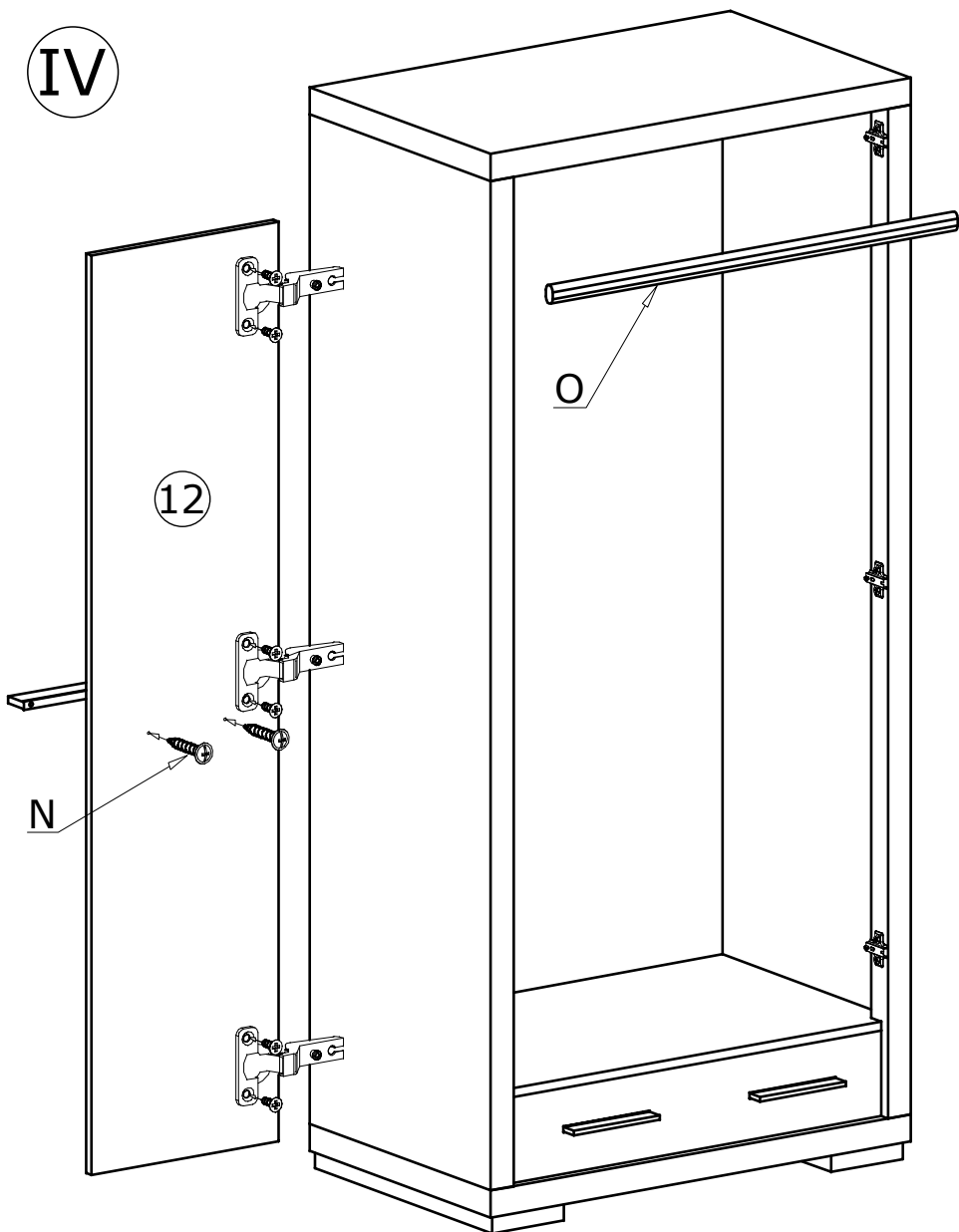

# MONTAŻ/DEMONTAŻ PROWADNIC

1

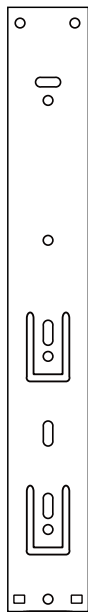

2

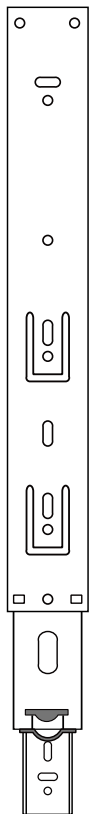

3

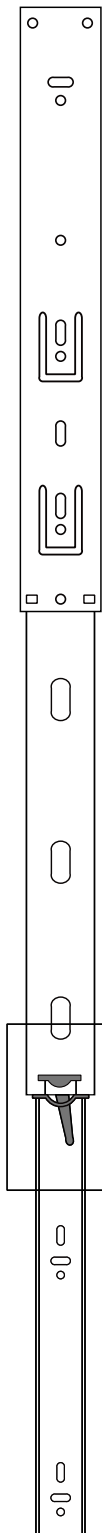

4

