

VEGAS 27

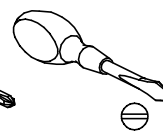

Narzędzia potrzebne do montażu

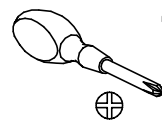
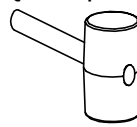
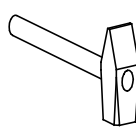

UWAGA !!!

MONTOWANIE USZKODZONYCH
ELEMENTÓW POWODUJE UTRATĘ
GWARANCJI

Nr	D[mm]	S[mm]	G[mm]	Ilość
1	800	160	48	1
2	800	320	16	1

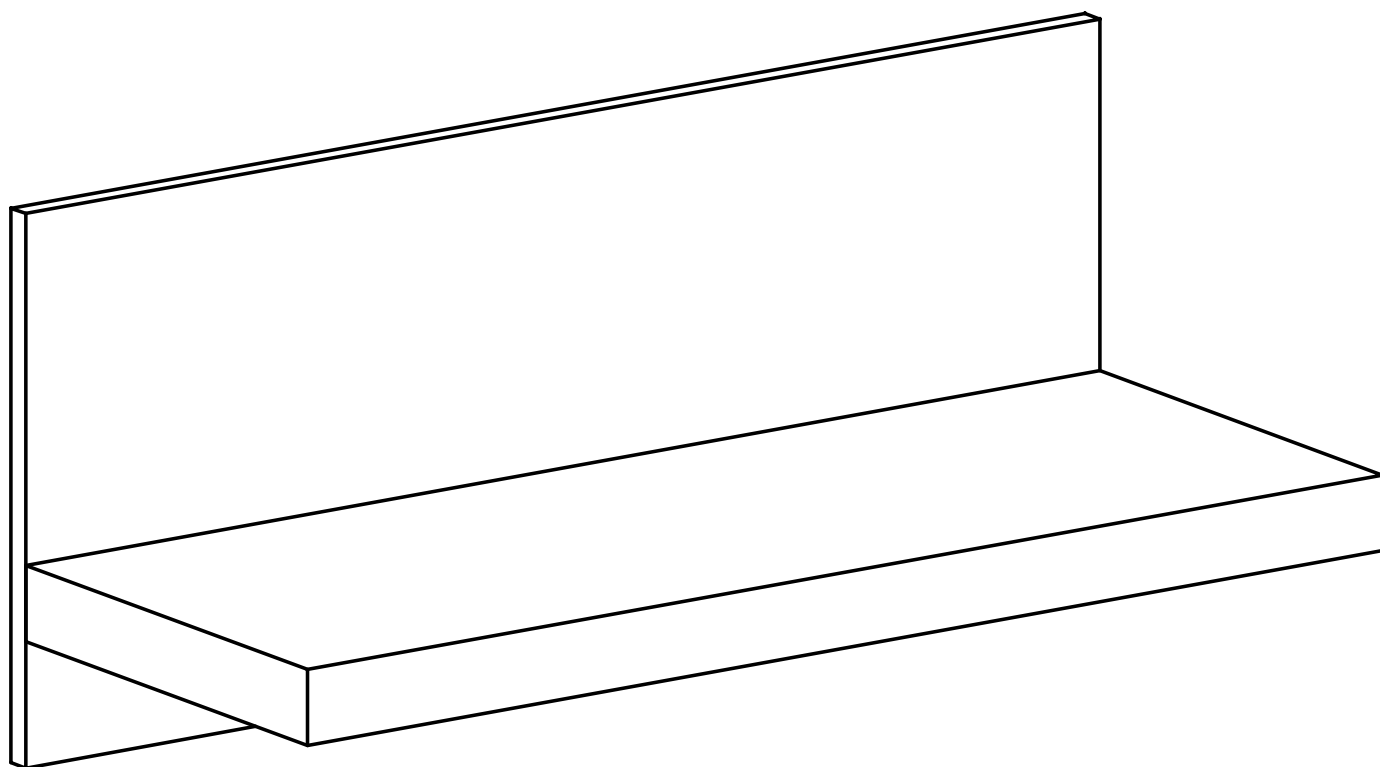

W przypadku reklamacji proszę podać numer pakowacza znajdujący się na kartonie.



E - 2 St.

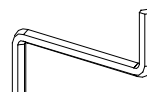

Z - 1 St.

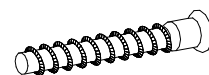

W - 3 St.

I

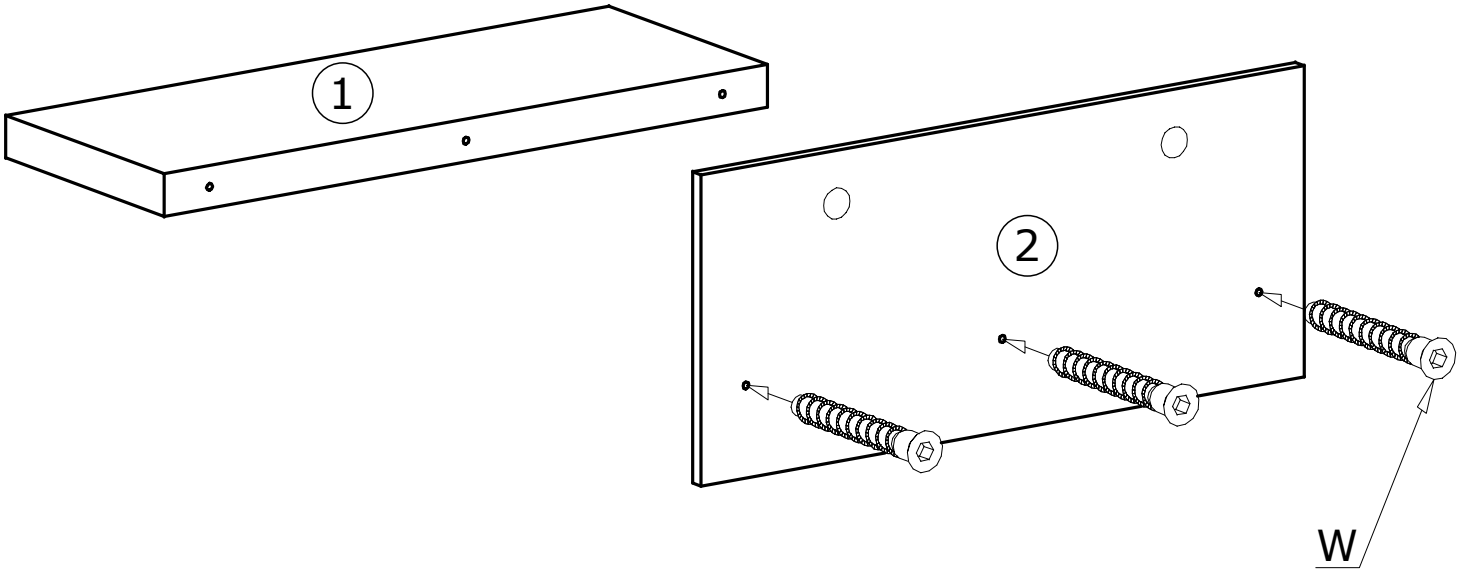

II

