

VEGAS 7

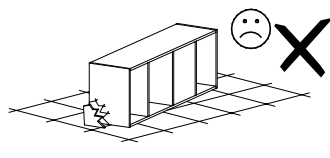

Narzędzia potrzebne do montażu

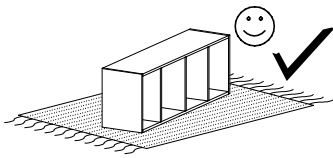
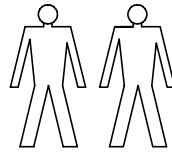
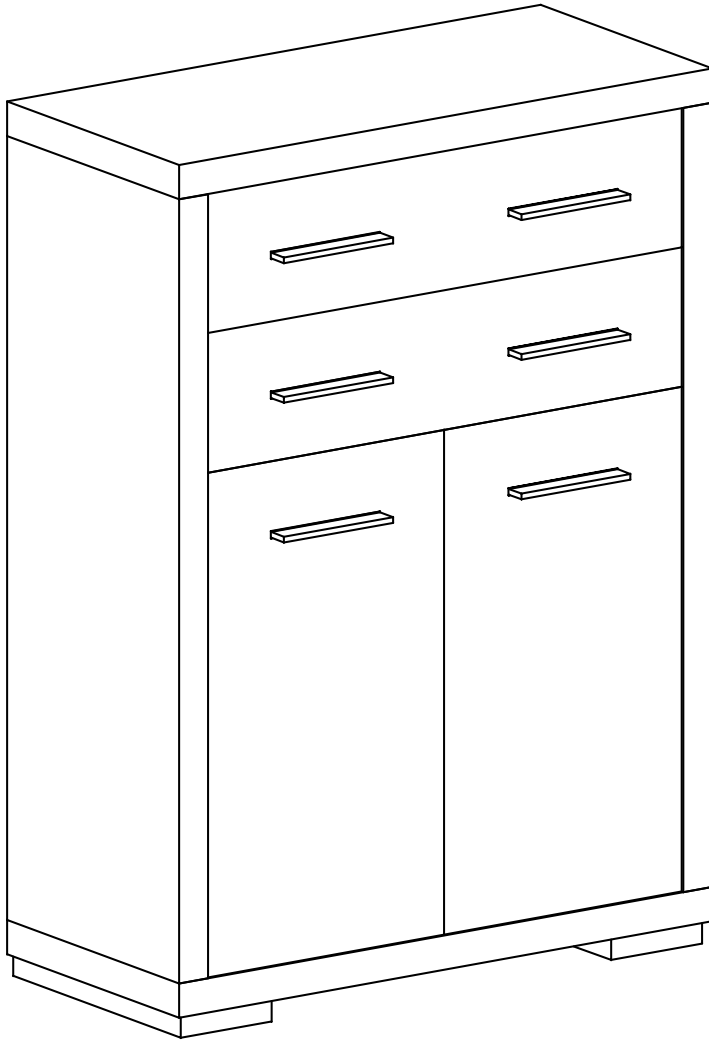
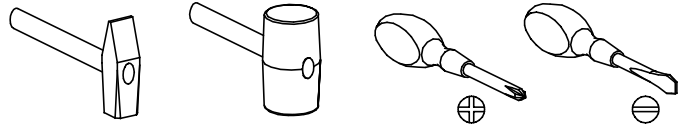

UWAGA !!!

MONTOWANIE USZKODZONYCH
ELEMENTÓW POWODUJE UTRATĘ
GWARANCJI

Nr	D[mm]	S[mm]	G[mm]	Ilość
1	883	407	48	1
2	883	407	48	1
3	1100	405	48	1
4	1100	405	48	1
5	848	388	16	1
6	780	190	16	2
7	350	165	16	2
8	726	165	16	2
9	350	165	16	2
10	757	355	2,5	2
11	870	790	2,5	1
12	700	388	16	2
13	700	388	16	2
14	870	360	2,5	1

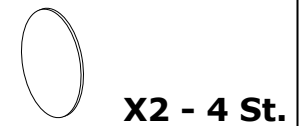
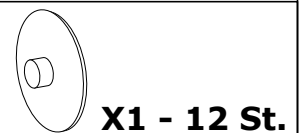

W przypadku reklamacji proszę podać numer pakowacza znajdujący się na kartonie.

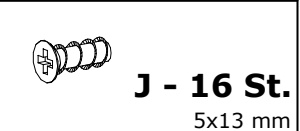
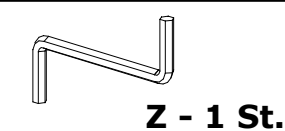
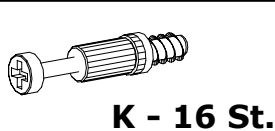
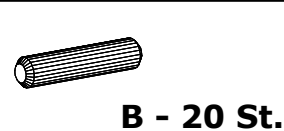
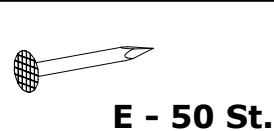
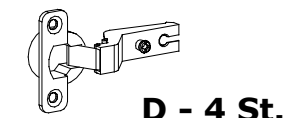
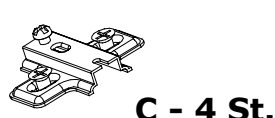
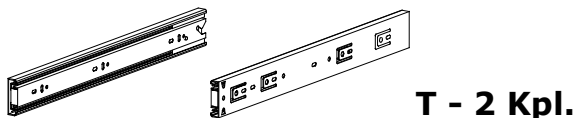
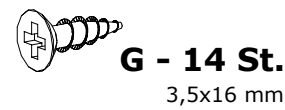
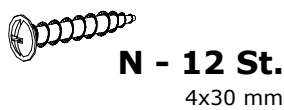
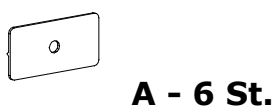
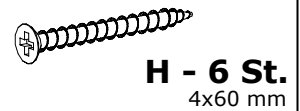
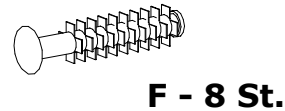
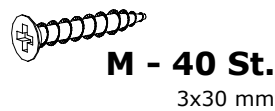
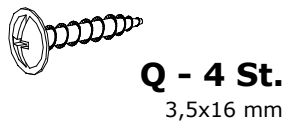
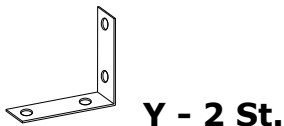

I

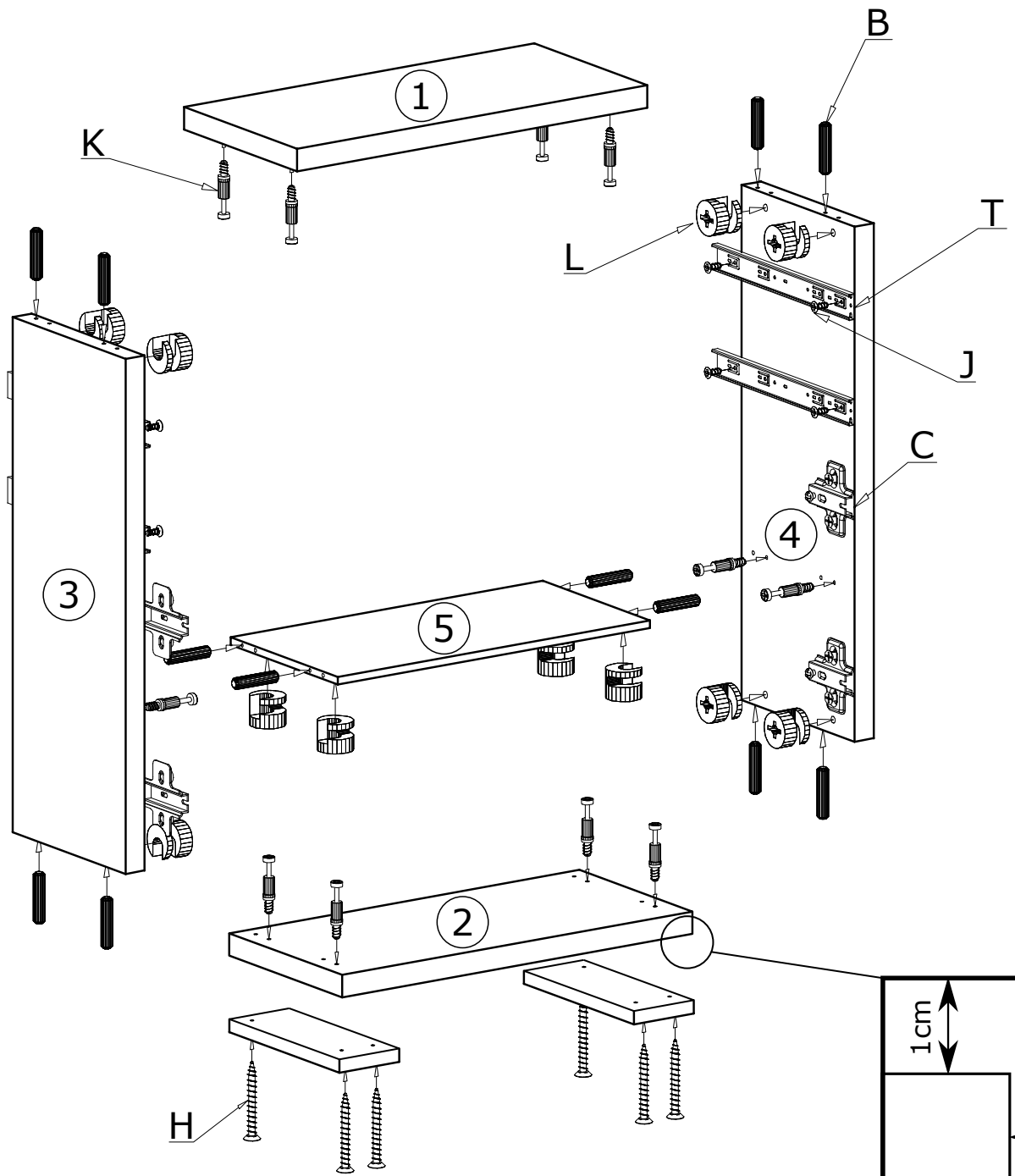

II

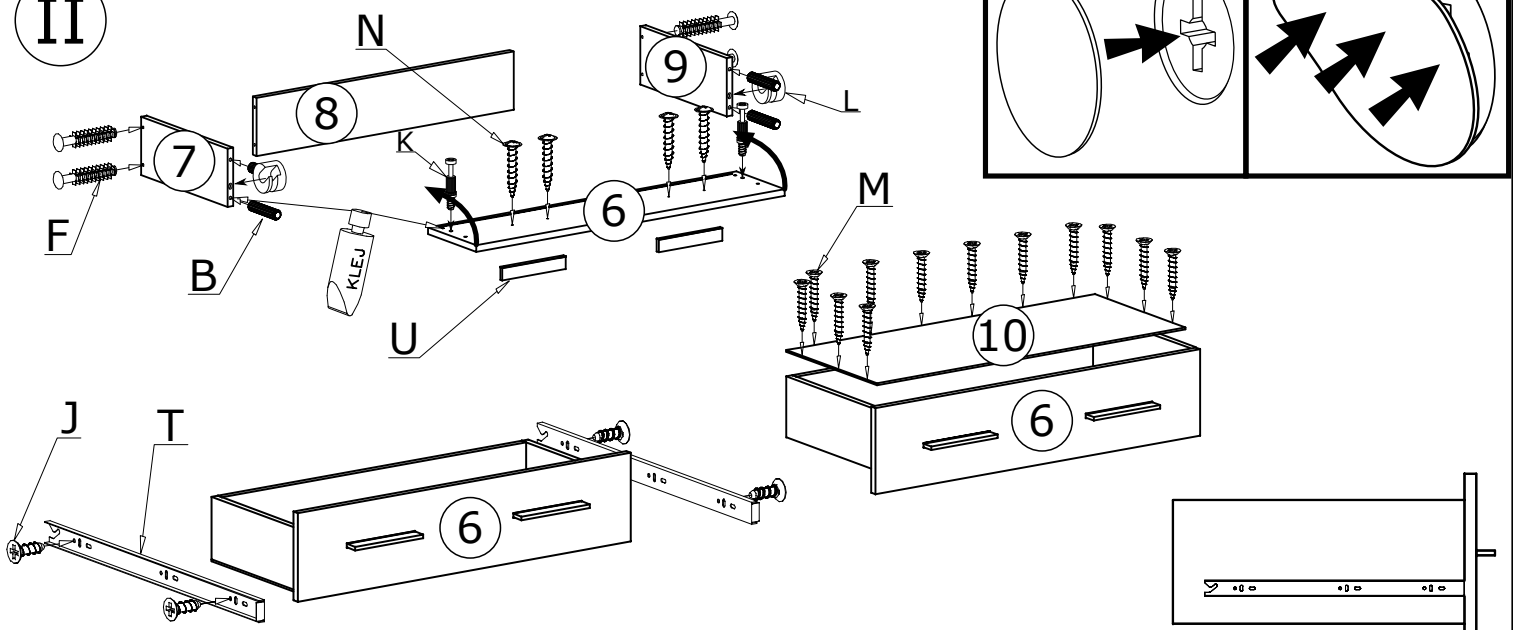

III

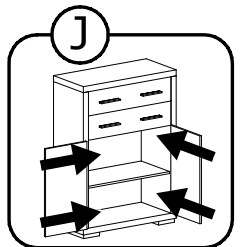
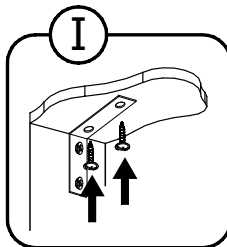
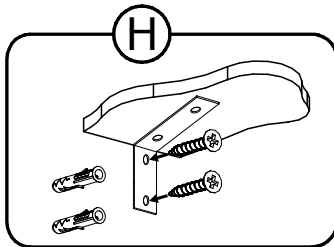
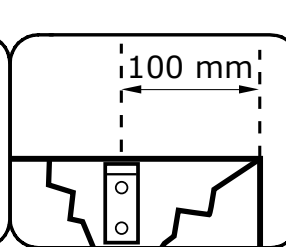
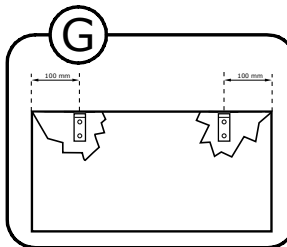
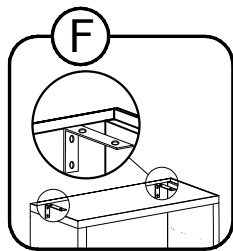
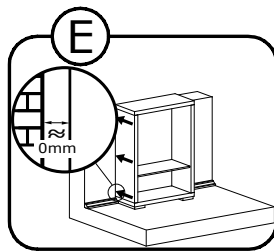
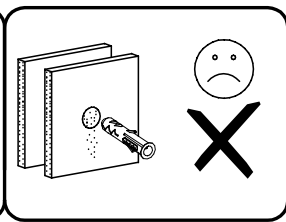
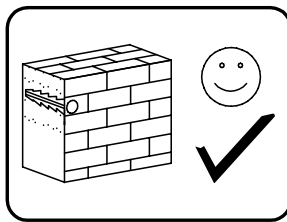
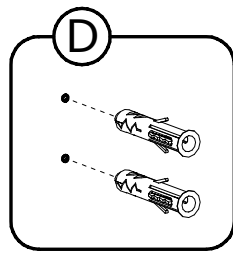
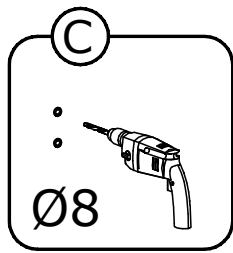
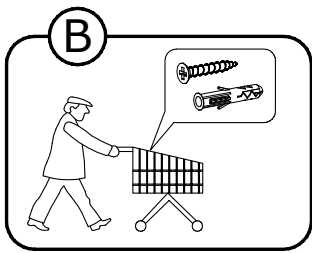
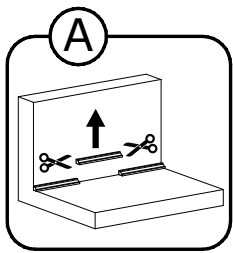
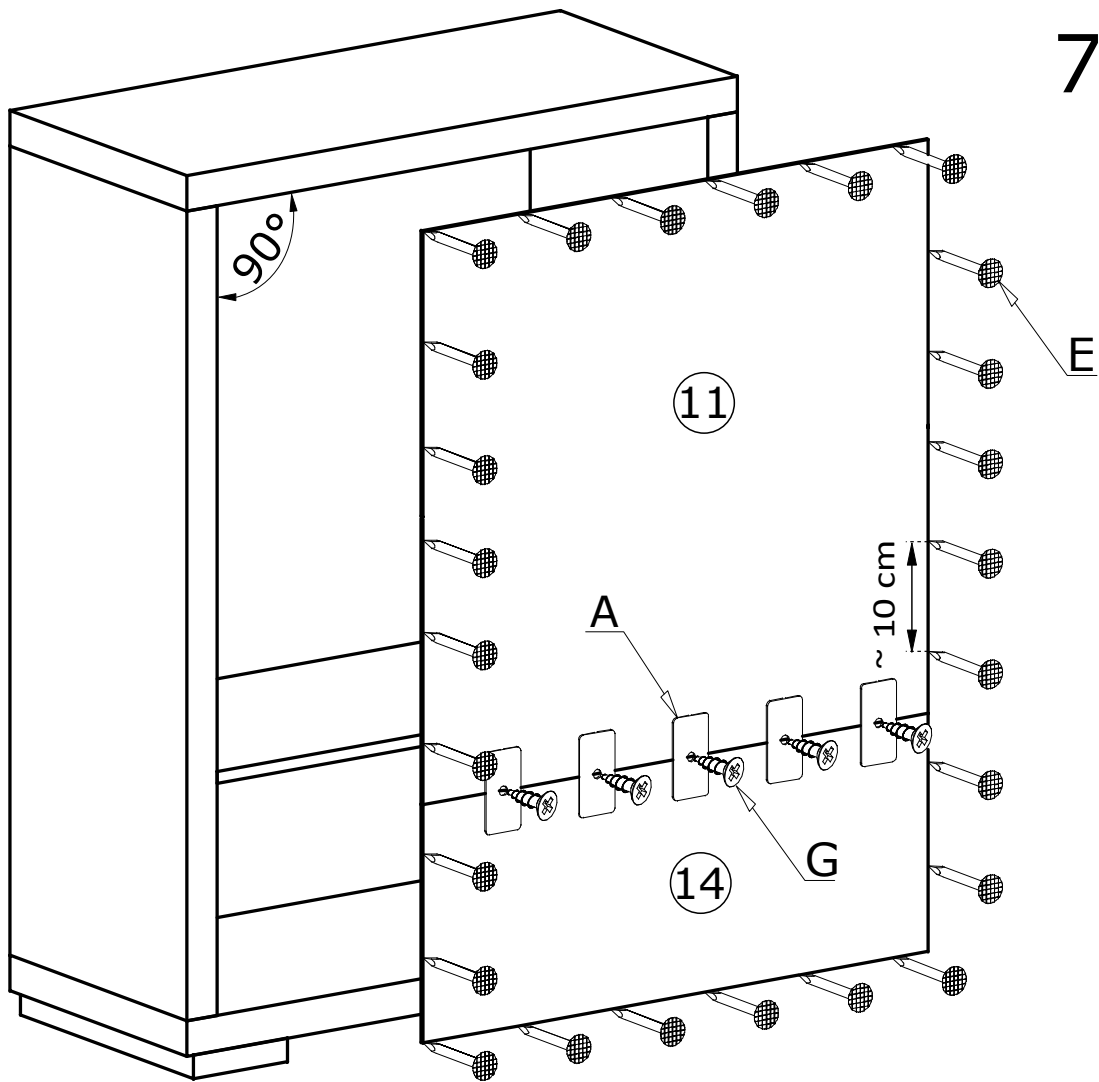

IV

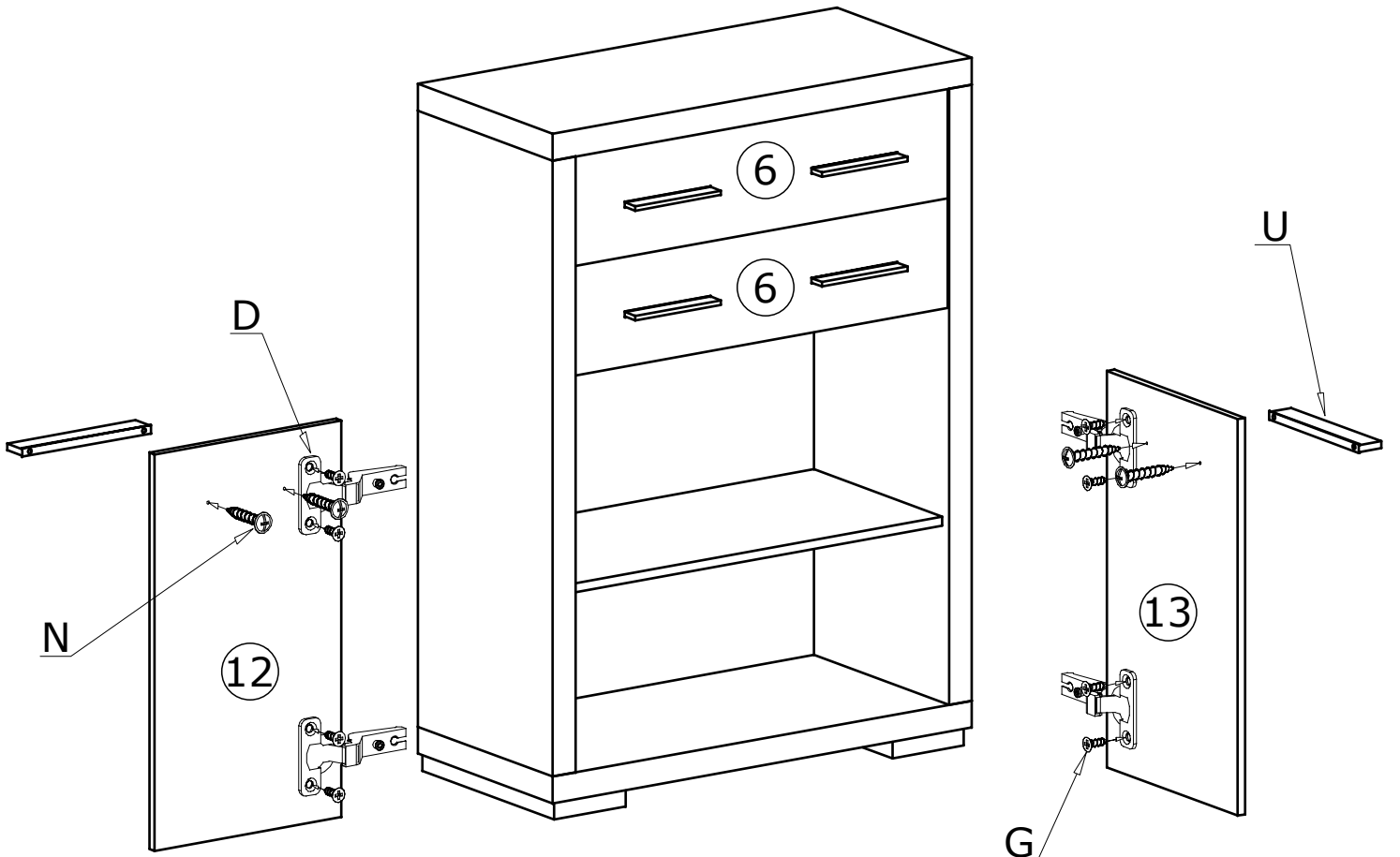
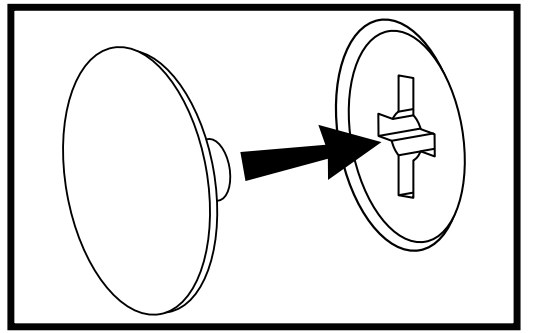

MONTAŻ/DEMONTAŻ PROWADNIC

1

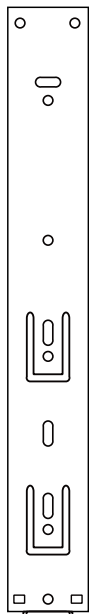

2

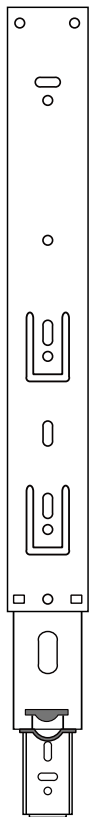

3

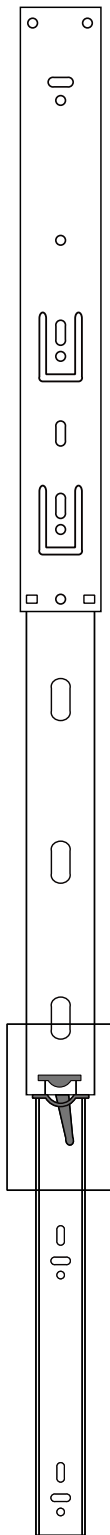

4

