

VEGAS 6

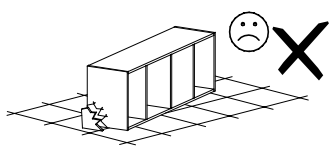

Narzędzia potrzebne do montażu

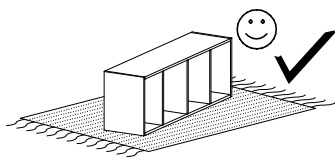
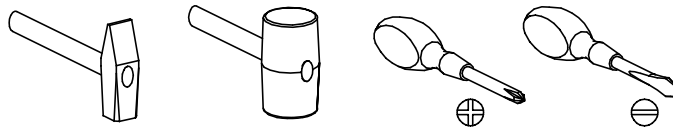

UWAGA !!!

MONTOWANIE USZKODZONYCH
ELEMENTÓW POWODUJE UTRATĘ
GWARANCJI

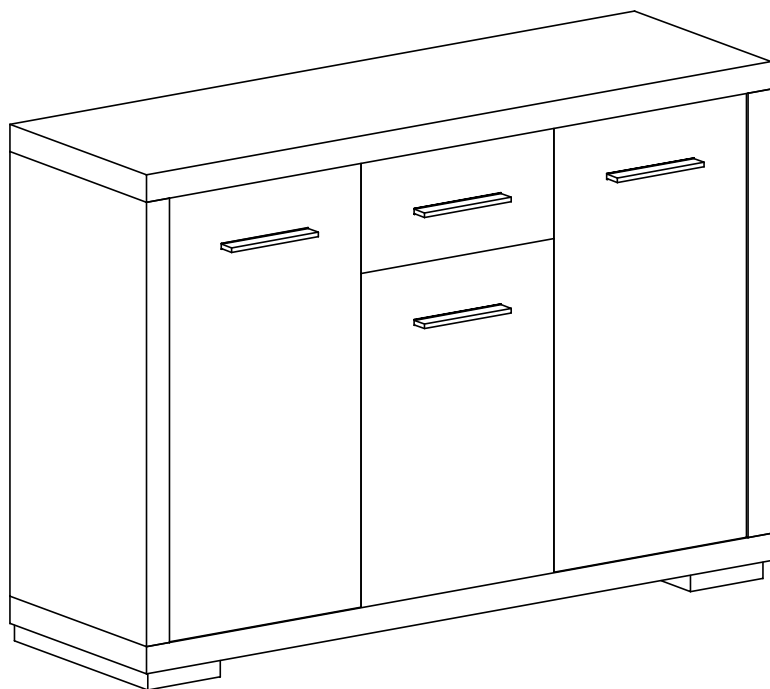

Nr	D[mm]	S[mm]	G[mm]	Ilość
1	1276	407	48	1
2	1276	407	48	1
3	783	405	48	1
4	780	388	16	1
5	780	388	16	1
6	783	405	48	1
7	394	320	16	2
8	417	320	16	1
9	1265	834	2,5	1
10	576	430	16	1
11	390	355	2,5	1
12	430	190	16	1
13	350	165	16	1
14	350	165	16	1
15	360	165	16	1
16	773	368	16	1
17	773	368	16	1

W przypadku reklamacji proszę podać numer pakowacza znajdujący się na kartonie.

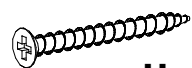

H - 6 St.
4x60 mm

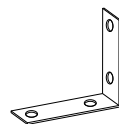

Y - 2 St.

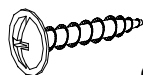

Q - 4 St.
3,5x16 mm



M - 14 St.
3x30 mm

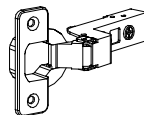

I - 2 St.

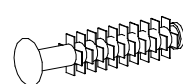

F - 4 St.

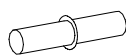

P - 12 St.

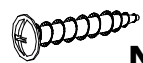

N - 8 St.
4x30 mm



U - 4 St.



G - 12 St.
3,5x16 mm



L - 16 St.

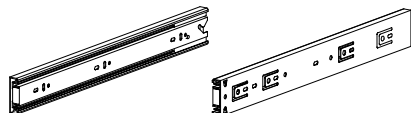

T - 1 Kpl.

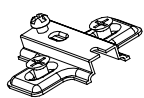

C - 6 St.

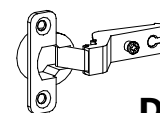

D - 4 St.



S - 1 St.



E - 50 St.



B - 20 St.

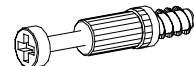

K - 16 St.

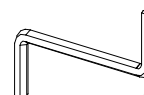

Z - 1 St.



J - 8 St.
5x13 mm

I

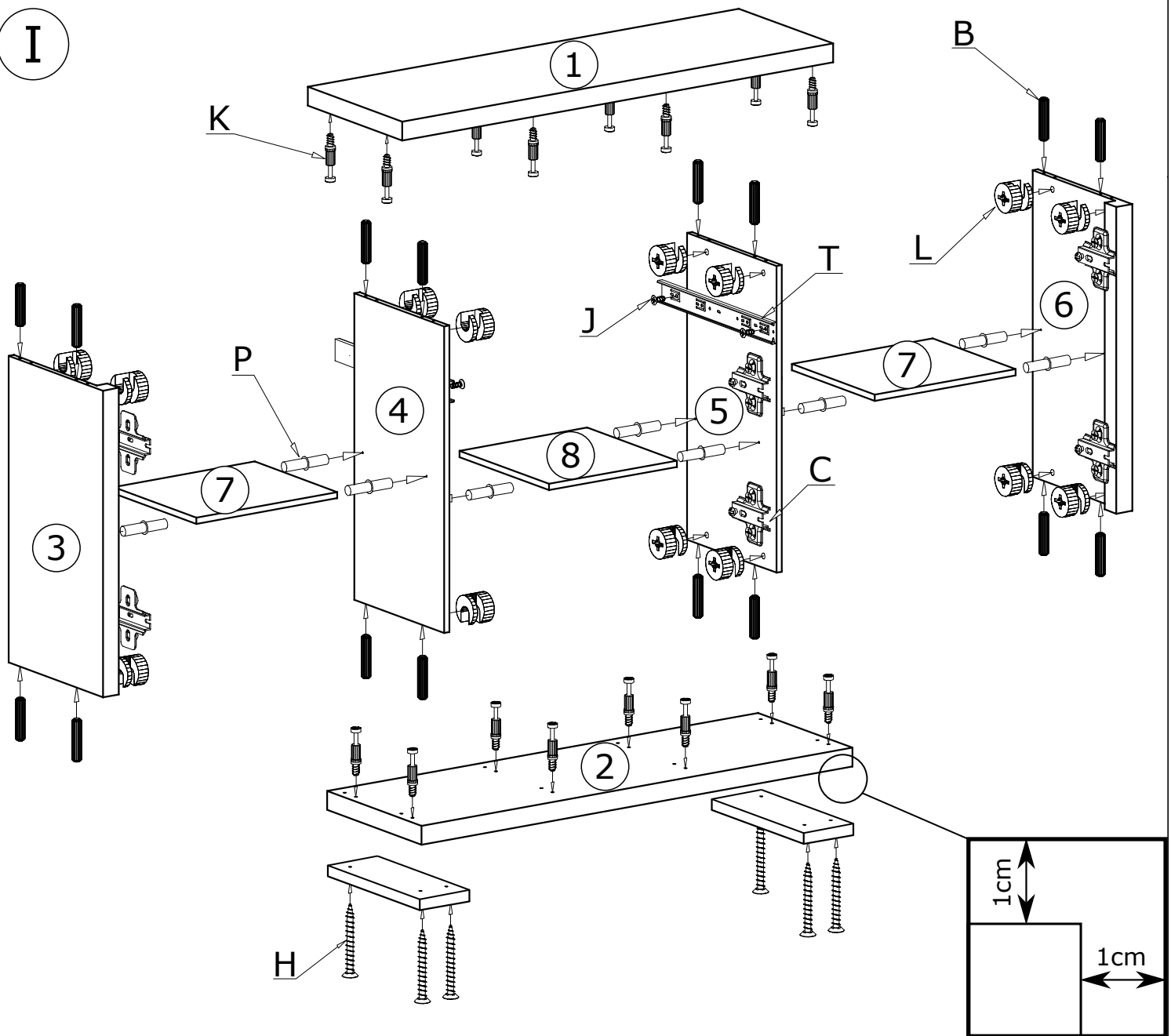

II

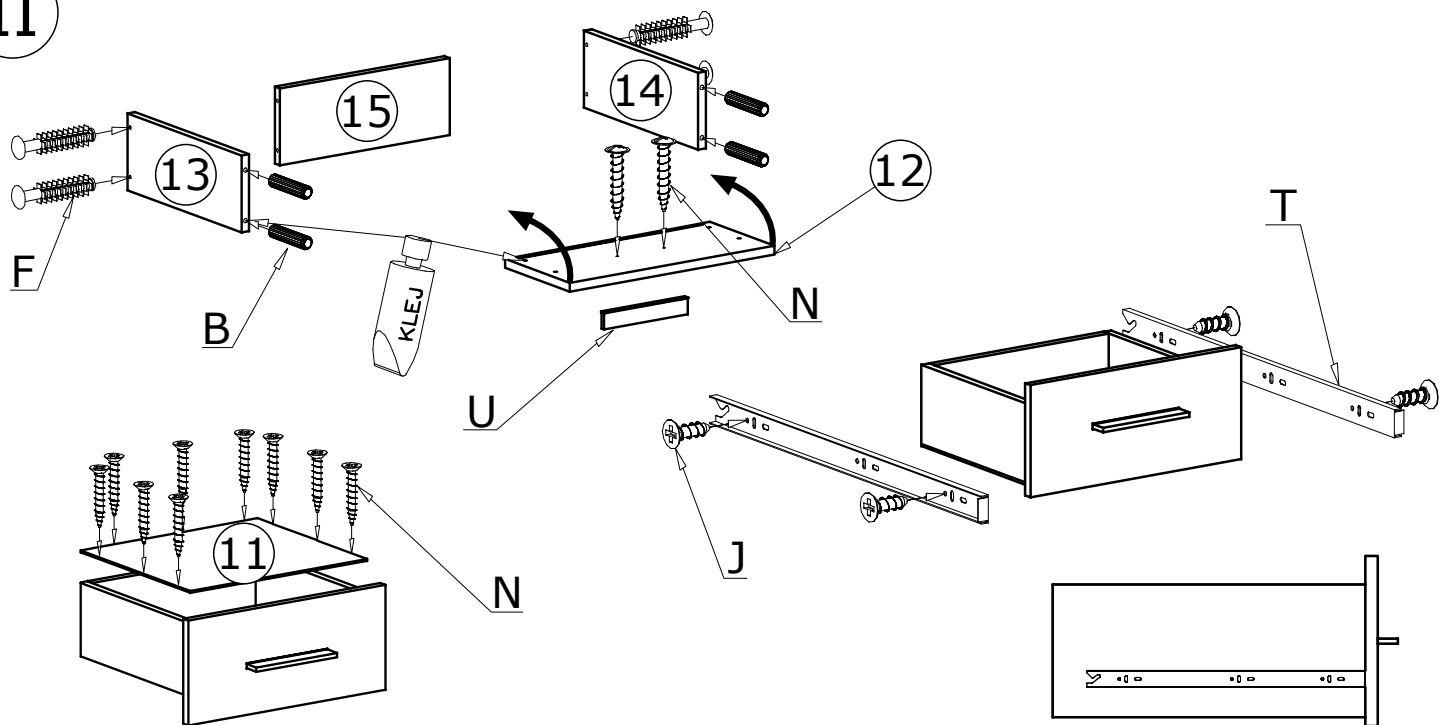

III

50X 

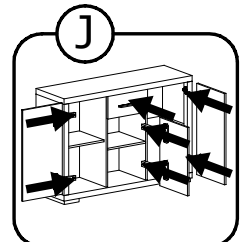
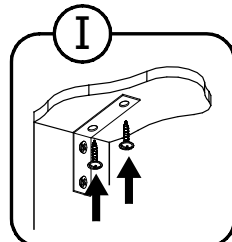
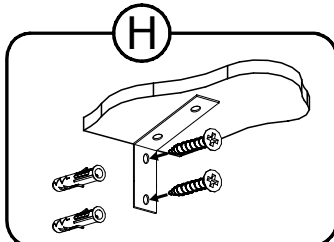
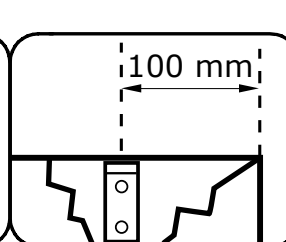
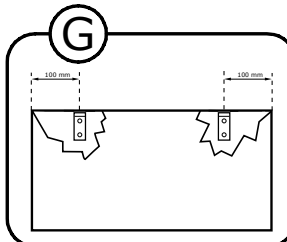
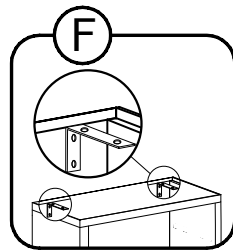
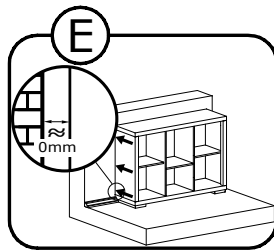
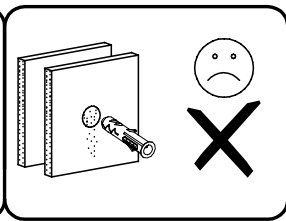
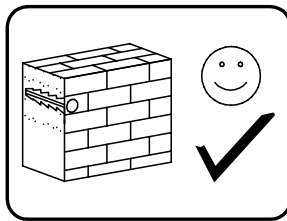
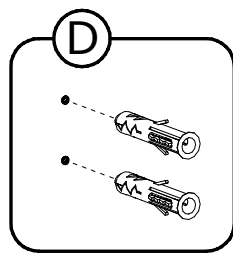
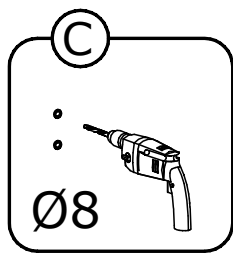
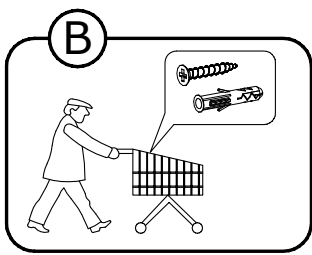
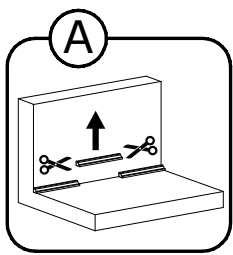
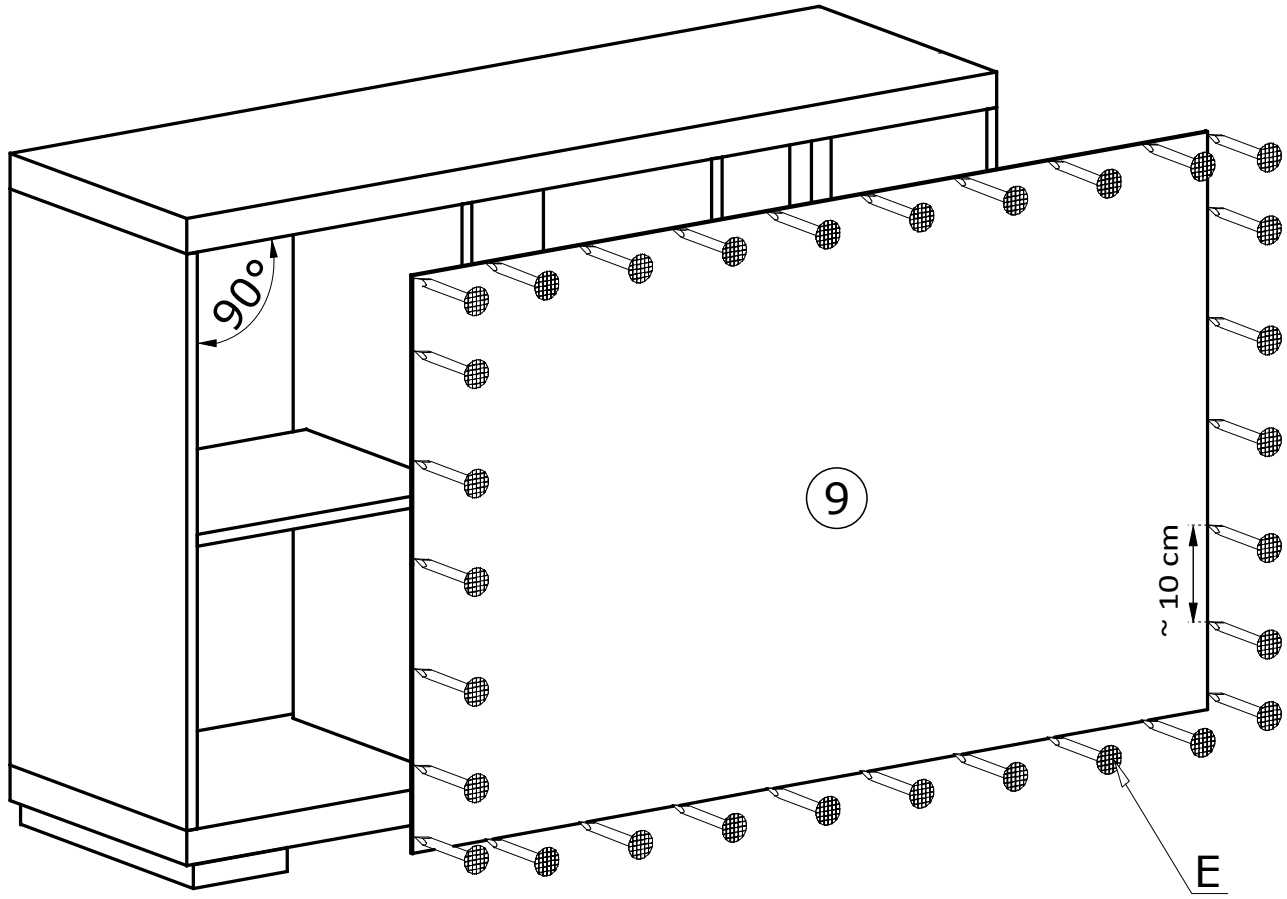

IV

