

# TADEUSZ 10

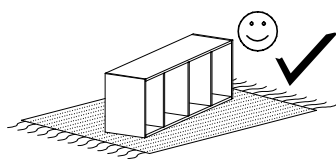

Narzędzia potrzebne do montażu

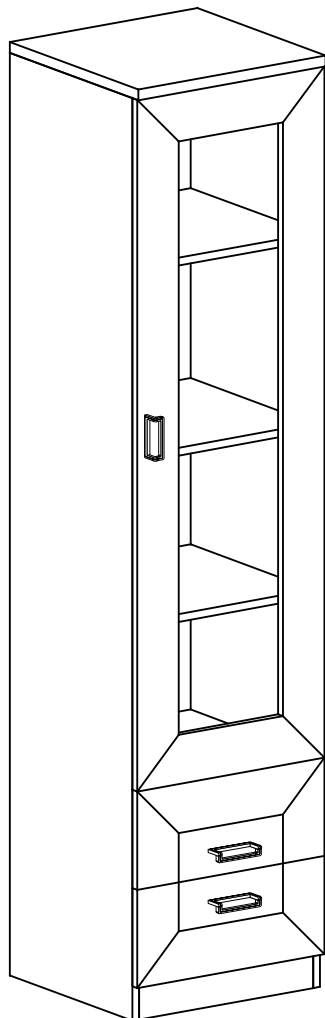
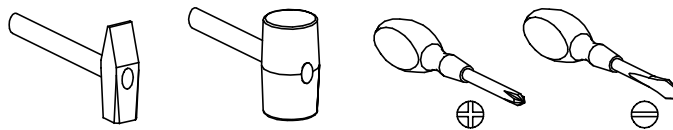

## UWAGA !!!

MONTOWANIE USZKODZONYCH  
ELEMENTÓW POWODUJE UTRATĘ  
GWARANCJI

Nr	D[mm]	S[mm]	G[mm]	Ilość
1	460	440	32	1
2	412	405	16	1
3	412	405	16	1
4	412	80	16	1
5	412	380	16	3
6	1870	405	16	1
7	1870	405	16	1
8	1394	438	16	1
9	1800	438	2,5	1
10	440	190	16	2
11	400	150	16	2
12	400	150	16	2
13	355	150	16	2
14	405	380	2,5	2

W przypadku reklamacji proszę podać numer pakowacza znajdujący się na kartonie.



**X1 - 4 St.**

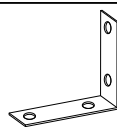

**Y - 2 St.**

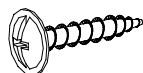

**I - 4 St.**  
3,5x16 mm



**X2 - 8 St.**



**X3 - 10 St.**



**X4 - 4 St.**

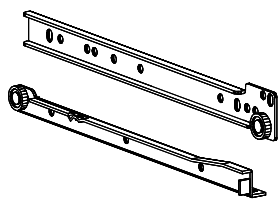

**T - 2 Kpl.**



**M - 8 St.**  
4x25 mm

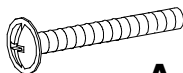

**A - 2 St.**  
4x37 mm



**Q - 4 St.**



**P - 12 St.**

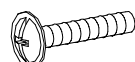

**N - 4 St.**  
4x25 mm



**U - 3 St.**



**G - 6 St.**  
3,5x16 mm



**L - 8 St.**

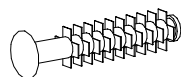

**F - 8 St.**



**E - 50 St.**

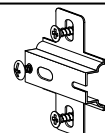

**C - 3 St.**

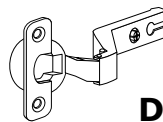

**D - 3 St.**



**S - 1 St.**

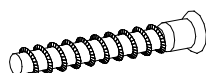

**R - 8 St.**



**B - 24 St.**

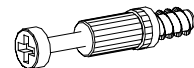

**K - 8 St.**

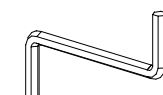

**Z - 1 St.**



**J - 8 St.**  
5x13 mm

I

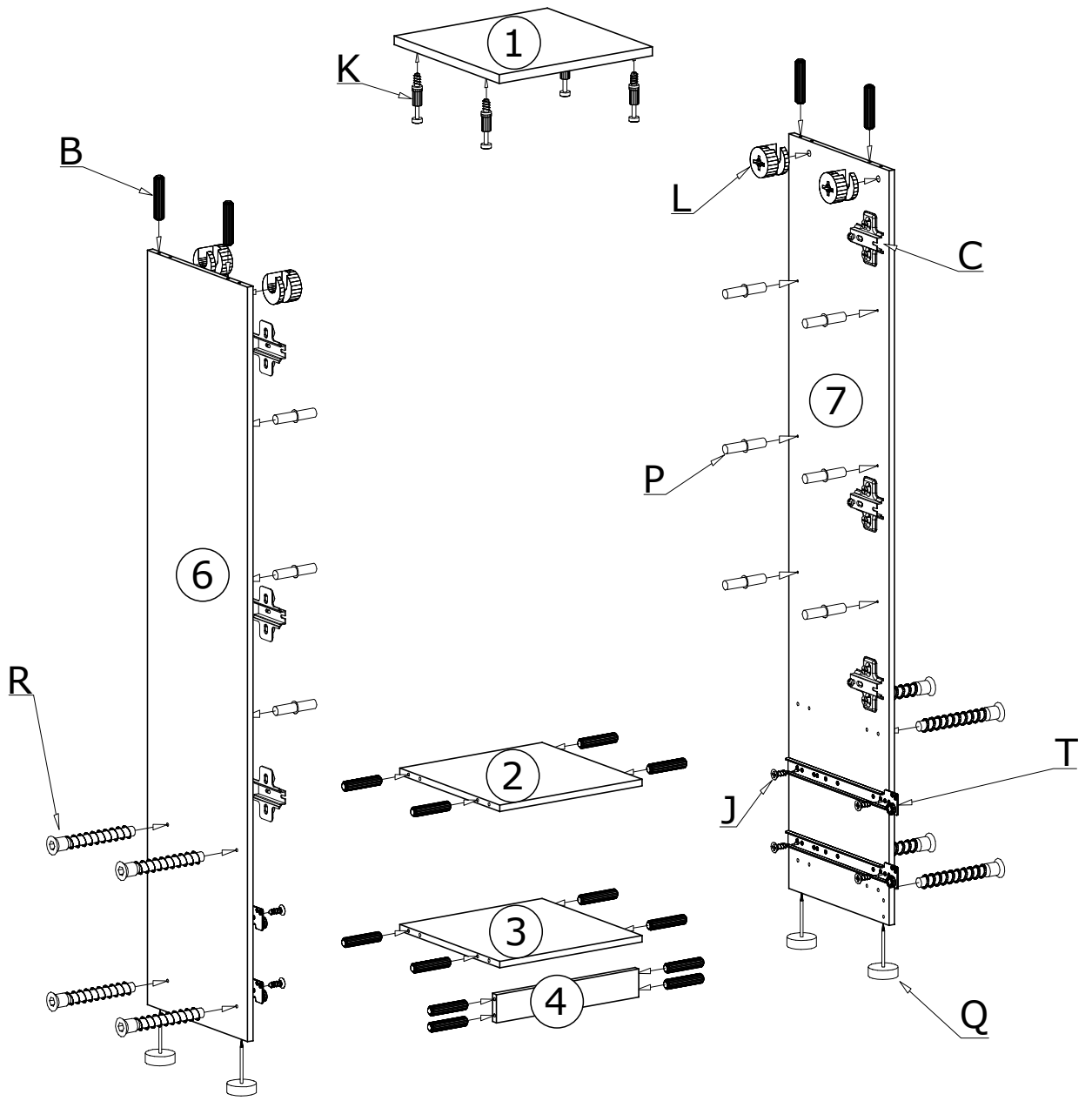

II

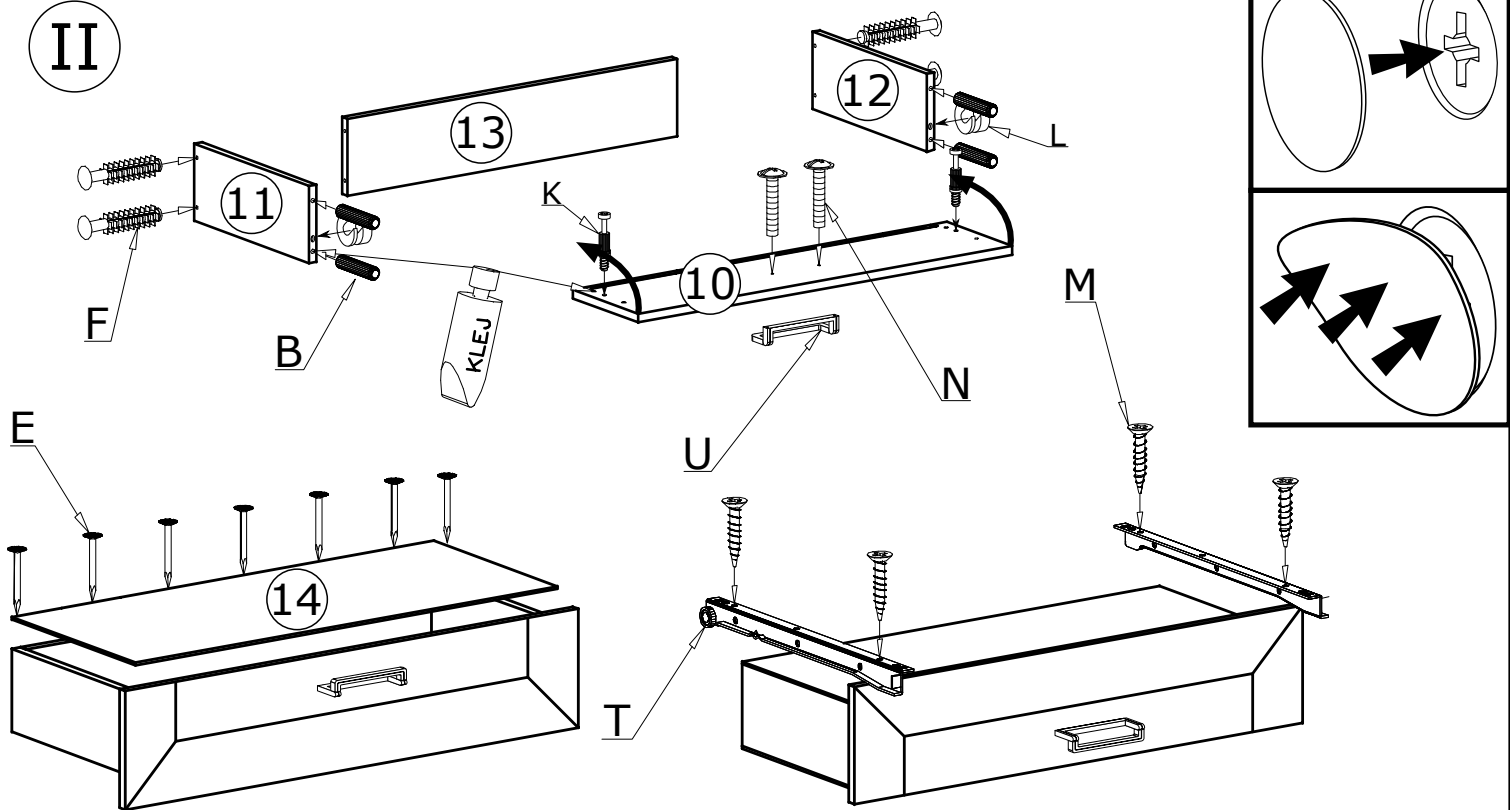

III

50X 

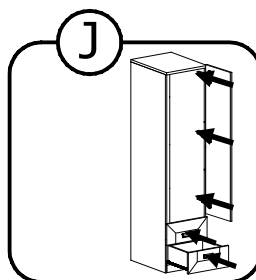
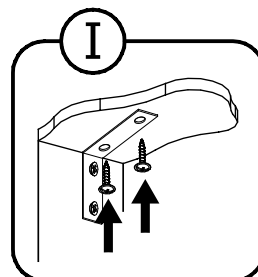
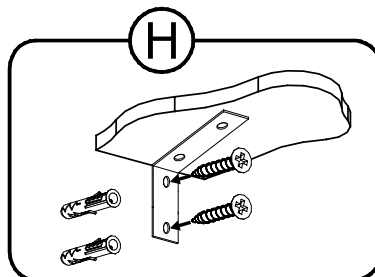
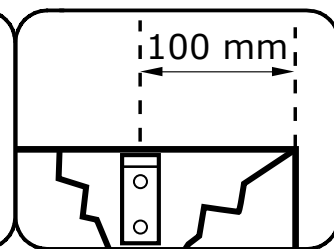
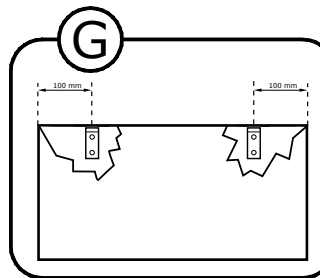
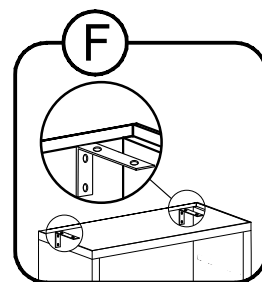
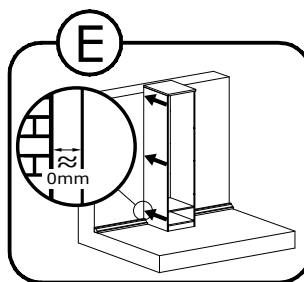
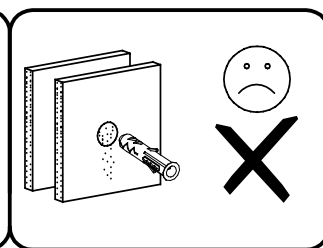
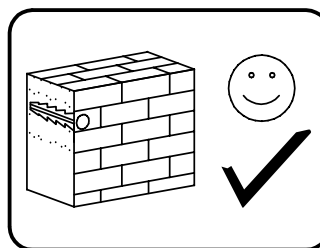
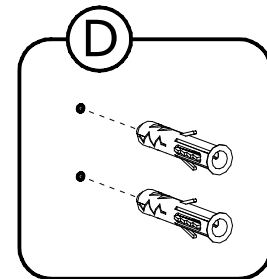
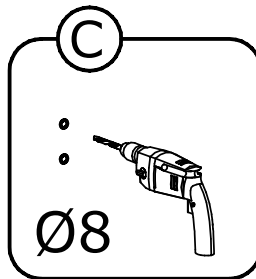
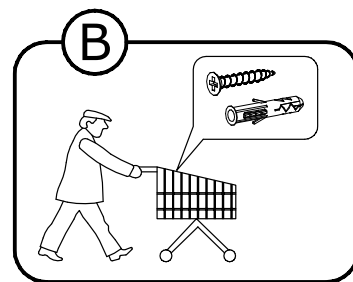
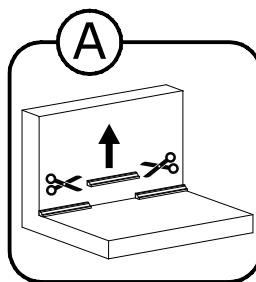
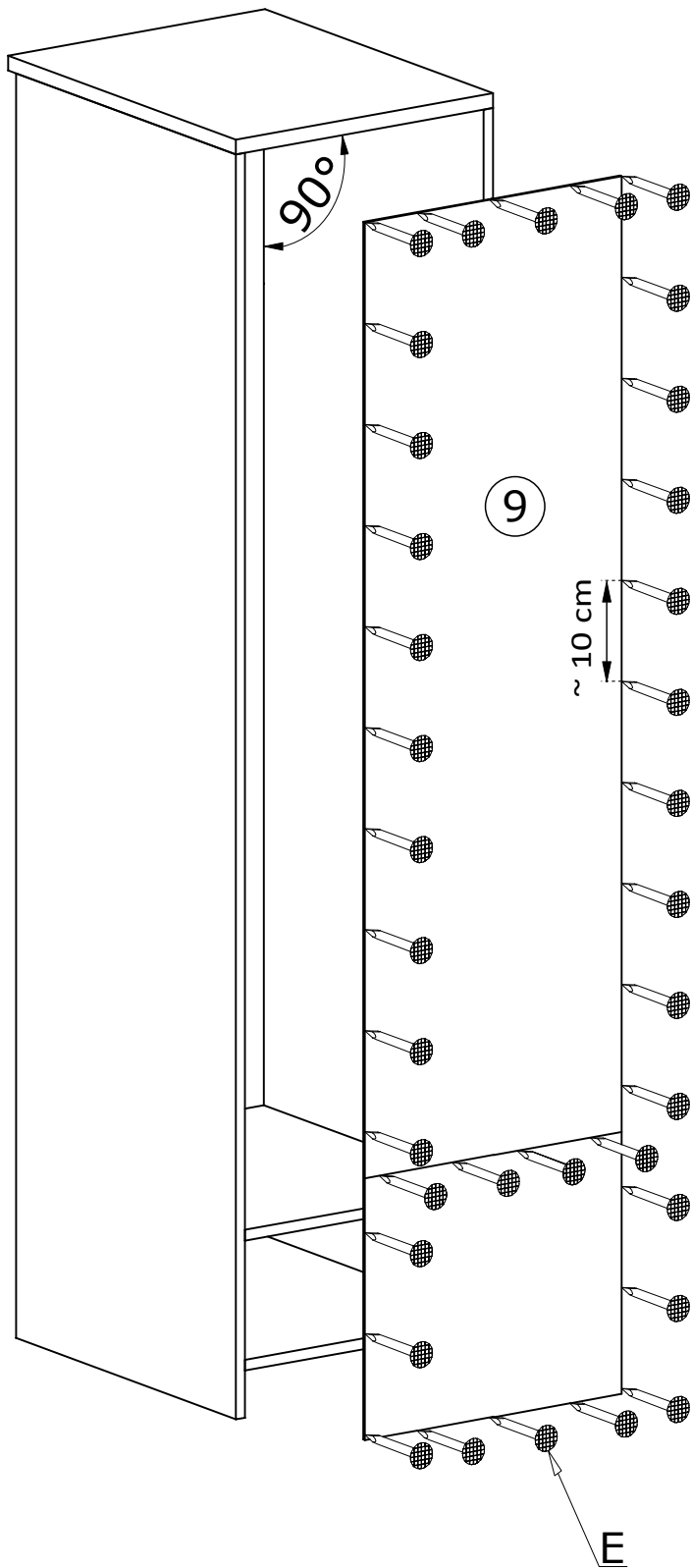

IV

